MOFFAT

E31 CONVECTION OVEN

SERVICE MANUAL





 **WARNING: ALL INSTALLATION AND SERVICE REPAIR WORK MUST BE CARRIED OUT BY QUALIFIED PERSONS ONLY.**



CONTENTS

This manual is designed to take a more in depth look at the E31 convection oven for the purpose of making the unit more understandable to service people.

There are settings explained in this manual that should never require to be adjusted, but for completeness and those special cases where these settings are required to change, this manual gives a full explanation as to how, and what effects will result.

SECTION	PAGE NO.
1. SPECIFICATIONS.....	5
2. INSTALLATION	7
3. OPERATION	9
3.1 Description of Controls	
3.2 Explanation of Control System	
4. MAINTENANCE.....	12
4.1 Cleaning	
4.2 Routine Procedures	
5. TROUBLE SHOOTING GUIDE	14
6. SERVICE PROCEDURES	17
6.1 Fault Diagnosis	
6.2 Access	
6.3 Replacement	
6.4 Adjustment / Calibration	
7. ELECTRICAL SCHEMATICS.....	32
8. ELECTRICAL WIRING DIAGRAMS	33
9. SPARE PARTS.....	34
10. ACCESSORIES / OPTIONS	35
11. PARTS DIAGRAM	36
11.1 Main Assembly	
11.2 Control Panel Assembly	
12. SERVICE CONTACTS.....	41
APPENDIX A. POWER RELAY UPGRADE KIT	43





IMPORTANT: MAKING ALTERATIONS MAY VOID WARRANTIES AND APPROVALS.

1. SPECIFICATIONS

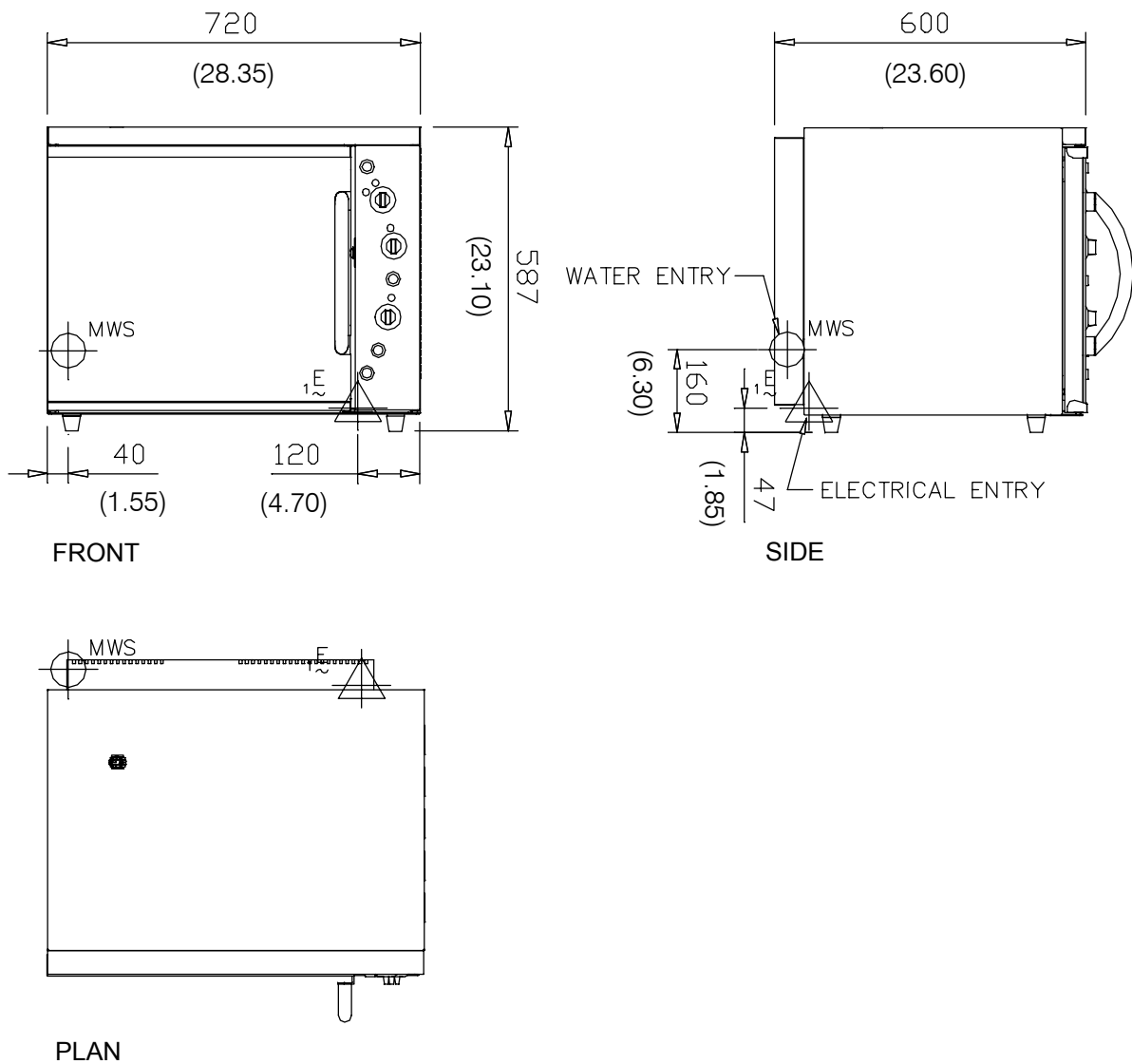
MODEL: E31



LEGEND

-  - Electrical connection entry point
-  - Water entry - 9mm / $\frac{3}{8}$ " I.D male hose connection

Dimensions shown in millimetres.
Dimensions in inches shown in brackets.

LOCATION

To ensure correct ventilation for the motor and controls the following minimum installation clearances are to be adhered to:

Top	200mm / 8"
Rear	25mm / 1"
Left-hand side	25mm / 1"
Right-hand side	25mm / 1"

OVEN INTERNAL DIMENSIONS

Width	468 mm / 18.5"
Height	418 mm / 16.5"
Depth	432 mm / 17"
Oven Volume	0.08 m ³ / 3.0 ft ³

OVEN RACK SIZE

Width	460 mm / 18"
Depth:	370 mm / 14.5"

ELECTRICAL SUPPLY SPECIFICATION OPTIONS

208 V AC 60 Hz, 14.6 A, 3.2kW @ 208 V
220-240 V AC 60 Hz, 13.0 A, 3.1kW @ 240 V
208-220 V AC 50 Hz, 14.6 A, 3.2kW @ 220 V
230-240 V AC 50 Hz, 13.0 A, 3.1kW @ 240 V

ELECTRICAL PLUG SPECIFICATION REQUIREMENTS

Australia	3-pin 250V 15A, AS/NZ 3112
Canada	3-pin 250V 15A, NEMA 6-15
New Zealand	3-pin 250V 15A, AS/NZ 3112
United Kingdom	3-pin 250V 13A fused, BS 1363A
United States	3-pin 250V 15A, NEMA 6-15
Other Countries	3-pin 250V 13A minimum, type to meet country standards

WATER SUPPLY CONNECTION

Max Pressure	550 kPa / 5.5 bar / 80 psi
Min Pressure	100 kPa / 1.0 bar / 15 psi

2. INSTALLATION

⚠ WARNING: THIS APPLIANCE MUST BE GROUNDED.

⚠ WARNING: ALL INSTALLATION AND SERVICE REPAIR WORK MUST BE CARRIED OUT BY QUALIFIED PERSONS ONLY.

It is most important that the oven is installed correctly and that the operation is correct before use. Installation shall comply with local electrical, health and safety requirements.

BEFORE CONNECTION TO THE POWER SUPPLY

Unpack and check unit for damage and report any damage to the carrier and dealer. Report any deficiencies to your dealer. Fit the feet which are packed inside the oven. Fit door handle to oven door. Check that the available power supply is correct to that shown on the rating plate located on the right-hand side panel (refer figure 2.3).

208 V AC 60 Hz, 14.6 A, 3.2kW @ 208 V
 220-240 V AC 60 Hz, 13.0 A, 3.1kW @ 240 V
 208-220 V AC 50 Hz, 14.6 A, 3.2kW @ 220 V
 230-240 V AC 50 Hz, 13.0 A, 3.1kW @ 240 V

LOCATION

To ensure correct ventilation for the motor and controls the following minimum installation clearances are to be adhered to:

Top	200mm / 8"
Rear	25mm / 1"
Left-hand side	25mm / 1"
Right-hand side	25mm / 1"

⚠ IMPORTANT: THE OVEN VENT LOCATED ON THE CABINET TOP MUST NEVER BE OBSTRUCTED.

Position the oven in its allocated working position. Use a spirit level to ensure the oven is level from side to side and front to back. (If this is not carried out, uneven cooking could occur). The feet/legs used with bench or floor mounting or provided with stands are adjustable and will require adjusting in levelling the unit. It should be positioned so the operating panel and oven shelves are easily reachable for loading and unloading.

DOUBLE STACKING UNITS

When it is desired to mount one unit on top of another the 31mm (1¼") high spacer feet must be used. These short feet should be screwed on, and the unit lifted on top of the bottom unit, where it locates safely under its own weight, for normal applications.

BEFORE USE

Operate the oven for about 1 hour at 200°C (400°F) to remove any fumes or odours which may be present.

ELECTRICAL CONNECTION

E31 convection ovens are supplied with pre-fitted cords. Ensure unit is fitted with the correct cord and plug for the installation (refer specifications section).

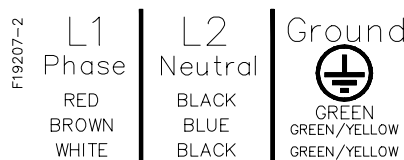

WARNING: THIS APPLIANCE MUST BE GROUNDED / EARTHED

Figure 2.1

Should changing of the cord be necessary, gain access to the electrical connection terminal block and strain relief by removing the back panel (four screws).

WATER CONNECTION

A cold water supply should be fitted to the water inlet (9mm / 3/8" hose connection) which is located on the rear of the left hand side of the unit.

Connect water supply - Max inlet pressure 80psi / 550kPa.

Turn on water supply to check for leaks.

⚠ IMPORTANT: MAXIMUM INLET WATER PRESSURE IS 550 kPa / 80 psi.

DOOR HANDLE INSTALLATION

1. Open oven door.
2. Remove two screws (item 2).
3. Remove the two screws (item 3) from the handle (item 1).
4. Install the handle bracket through the slot on the door side.
5. Screw in the two screws (item 2) fully, then fully screw in the previous two screws (item 3). Ensure that they are tight.

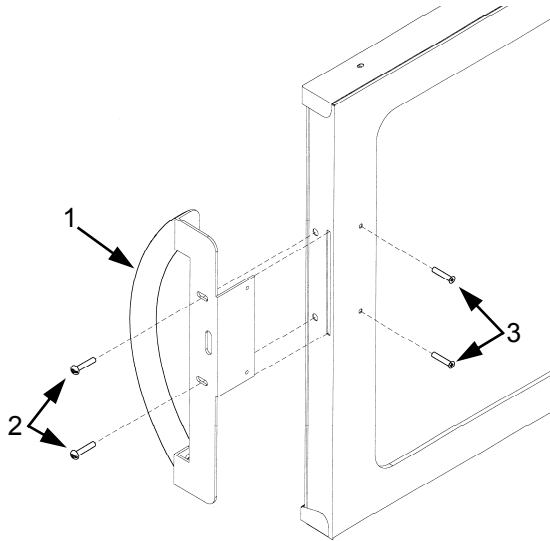

Figure 2.2

RATING PLATE LOCATION

The rating plate for the E31 convection oven is located at the bottom left corner of the RH side panel.

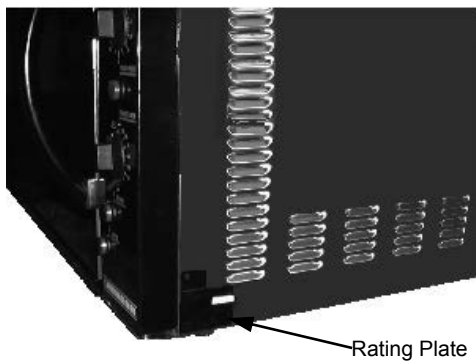
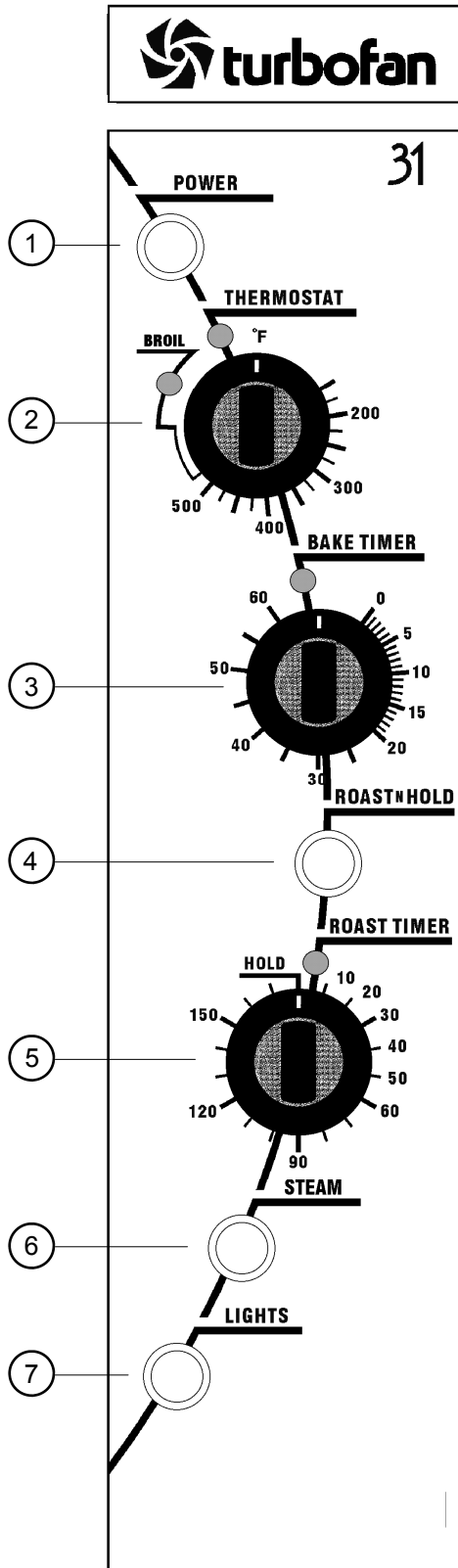

Figure 2.3

3. OPERATION

NOTE: A full user's operation manual is supplied with the product and can be used for further referencing of installation, operation and service.

3.1 DESCRIPTION OF CONTROLS



1. POWER

Depress to switch power on or off (switch illuminates when power is on).

2. THERMOSTAT

Temperature range 50 - 280°C (120 - 550°F). Indicator illuminates when elements are cycling ON to maintain set temperature.

GRILL POSITION - The GRILL indicator will illuminate indicating that the GRILL function has been set. The HEATING indicator will also illuminate whenever the elements are on.

3. BAKE TIMER

1 Hour bake timer. (Indicator illuminates when "time up" (0) reached, and buzzer sounds).

4. ROAST N HOLD

Depress switch to activate 'ROAST N HOLD' function (Switch illuminates when ON).

5. ROAST TIMER

3 Hour roast timer. (Indicator illuminates when "time up" (0) reached, and product held at 75°C (167°F).

6. STEAM SWITCH

Push switch to activate water injection (Water injects into oven while the button is depressed).

7. LIGHT SWITCH

Push switch to activate oven light. (Light illuminates while button depressed).

3.2 EXPLANATION OF CONTROL SYSTEM

The E31 Turbofan convection oven features multi-function operator controls for which a correct understanding of their operation is required before carrying out any service or fault repair work. The control device functions are explained as follows:

A power switch on the control panel isolates all to the controls of the oven. With the power switch Off all functions of the oven are inoperable.

With the power switch On (illuminated) power is directly supplied to the 60 minute bake timer, steam (water injection) switch, door microswitch, light switch, and the temperature control circuit. Accordingly the oven circulation fan will operate when the door is closed, and with door open the oven light will come on and the circulation fan will shut down, as these are controlled via the door microswitch. The control panel light switch will turn the oven light on when the door is closed only when the light switch is held in.

The 60 minute timer is a mechanical timer and can therefore be operated with the oven's power switch On or Off. However, only with the oven's power switch On will the switch contacts of the 60 minute timer turn on the time-up buzzer and illuminate the time-up indicator on the control panel. The buzzer and time-up indicator provide indication that the time setting has run down to zero and at this point will remain On continuously until the 60 minute timer has been manually set back to the Off (vertical) position. The 60 minute timer does not control any other part of the oven's operating system as this timer is independent of the temperature control and heating system.

The steam (water injection) switch on the control panel can be operated whenever the power switch is On. The switch is momentary like the light switch and when depressed, will operate the electric solenoid valve at the rear of the oven and inject water into the water trough at the bottom of the left hand side rack in the oven. Releasing the steam button will close the solenoid valve. This feature is used to instantaneously add moisture into the oven cavity, or to introduce a reservoir of water in the water trough to maintain humidity in the oven chamber and minimise product's

moisture loss during cooking.

The temperature control of this oven is with a capillary type thermostat which can be set to a required cooking temperature, or set to the Grill/Broil position to provide top browning or grilling/broiling in the oven.

The thermostat switch has a separate switch body assembled onto the front from the shaft assembly and when the thermostat is set to a cooking temperature, one set of contacts is closed to switch power from the oven thermostat to the bottom heating element in the oven. The second switch contact of this switch assembly remains open in this setting and isolates power from the top element inner coil. The top element outer coil is directly switched on from the oven thermostat. Accordingly only the top outer element and the bottom element are used when a cooking temperature is selected. The control panel indicator light above the thermostat knob cycles On and Off with the thermostat to indicate when the elements are on and the oven is heating.

When the thermostat control is set to the Grill position the first switch contact opens and the second switch contact closes. This arrangement allows power to be provided to the top element inner coil when the thermostat is On, and isolates power from going to the bottom heating element. The top element outer coil which is directly fed from the oven thermostat switch is therefore On in conjunction with the top element inner coil when the thermostat is set to the Grill position. As both the top inner and outer element coils are thermostatically controlled, the elements will cycle On/Off with the door closed as the thermostat setting in the Grill position is 300°C (600°F). If the Grill position is selected with the door open, the elements will remain On continuously and the circulation fan will be turned Off. The control panel Grill indicator will illuminate when the thermostat is set to the Grill position and will cycle On and Off with the main heating indicator light.

The E31 Turbofan convection oven features a Roast-and-Hold system which can be used to automatically set the oven to a fixed holding temperature at the end of a timed cooking period. When the Roast-and-Hold switch is turned On the switch will illuminate and turn on a mini-contactor found on the inside of the control panel. When the contactor is switched On a normally closed switch pole on the

contactor is open and the normal power supply to the oven thermostat is isolated. A second normally open switch pole is closed and this provides power to the 3 hour roast timer.

If the roast timer is in the Hold (vertical) position the timer switch contacts will be in their normally closed position and supply power directly to the Hold thermostat located behind the control panel. The Hold thermostat is factory set to 75°C (167°F) and will directly supply power to the bottom heating element as required to maintain its preset temperature.

If the main thermostat is turned On, power will also be supplied to the top outer element coil through the first switch contact of the thermostat front switch assembly. In this case the thermostat heating light will also cycle On/Off as the Hold thermostat maintains temperature.

In the Roast-and Hold mode the 3 hour timer can be set to a selected roasting time. During this time period the normally open switch contacts of the timer are closed. The timer has two change over switches and in this position one is used to supply power to its timing motor and the other is used to switch power directly to the main oven thermostat. During the 3 hour timer run-down period the oven temperature will be controlled by the main oven thermostat to the set temperature and operate as previously described.

When the 3 hour timer has run down and reached the Hold position the two switch contacts change over to their normally closed position which isolates power from the timer motor and the oven thermostat. It also switches power back to the oven hold thermostat. At this point the temperature control is now maintained by the hold thermostat as previously described. To cancel the hold circuit the Roast-and-Hold switch is turned Off. This turns off the contactor which removes power from the 3 hour timer and closes the contactor pole on the contactor that feeds the main oven thermostat.

The factory preset hold thermostat can be adjusted as required to change the holding temperature if necessary. Refer Service section for this procedure.

The following Troubleshooting Guide should

be used to identify any incorrect oven operation. On correct identification of the operating fault the Troubleshooting Guide will make reference to the corrective action required, or refer to the Fault Diagnosis section and/or Service section to assist in correction of the fault.

4. MAINTENANCE

 **WARNING:** ALL INSTALLATION AND SERVICE REPAIR WORK MUST BE CARRIED OUT BY QUALIFIED PERSONS ONLY.

4.1 CLEANING

 **WARNING:** ALWAYS TURN THE POWER SUPPLY OFF BEFORE CLEANING.

 **IMPORTANT:** THIS UNIT IS NOT WATER PROOF. DO NOT USE A WATER JET SPRAY TO CLEAN INTERIOR OR EXTERIOR OF THIS UNIT.

EXTERIOR

Clean with a good quality stainless steel cleaning compound. Harsh abrasive cleaners may damage the surface.

INTERIOR

Ensure that the oven chamber is cool. Do not use wire brushes, steel wool or other abrasive materials. Clean the oven regularly with a good quality oven cleaner. Take care not to damage the fan or the tube at the right side of the oven which controls the thermostat.

OVEN RACKS

To remove, slide out to the stop position, raise the front edge up, and lift out.

SIDE RACKS

To remove, take hold of the centre rung and swing towards the oven top. To replace, hold horizontally, engage in holes and swing down.

FAN BAFFLE

To remove, unscrew the oven lamp glass and lift the baffle out. To replace, locate the bottom edge of the baffle over the bottom element terminal plate and secure in place with the oven lamp glass.

 **IMPORTANT:** DO NOT OVERTIGHTEN LAMP GLASS.

OVEN SEALS

To remove, hold at their centre point and pull forward until they unclip. Remove side seals first, then top and bottom. The seals may be washed in the sink, but take care not to cut or damage them. To replace, ensure that the lip is facing the oven opening. Fit the top and bottom seals first, then the side seals.

OVEN DOOR GLASS

Clean with conventional glass cleaners

4.2 ROUTINE PROCEDURES

	PROCEDURE	INTERVAL
DOOR SEALS	Check for deterioration.	12 months
DOOR PIVOT BUSHES	Check for wear.	12 months
DOOR CATCH	Ensure that catch is adjusted such that the door closes properly.	12 months
ELEMENTS	Check that element resistances are correct to their rating (refer 6.3.13)	12 months
WATER NOZZLE	Check for liming / scale build-up in water nozzle.	12 months

5. TROUBLE SHOOTING



WARNING: ALL INSTALLATION AND SERVICE REPAIR WORK MUST BE CARRIED OUT BY QUALIFIED PERSONS ONLY.

FAULT	POSSIBLE CAUSE	REMEDY
THE OVEN DOES NOT OPERATE / START	<p>The mains isolating switch on the wall, circuit breaker or fuses are "off" at the power board.</p> <p>The power switch on the oven is off.</p> <p>Incorrect electrical supply. (Refer fault diagnosis 6.1.1)</p> <p>Power switch on unit faulty. (Refer fault diagnosis 6.1.1)</p>	<p>Turn on.</p> <p>Depress switch. Switch will illuminate.</p> <p>Ensure electrical supply correct.</p> <p>Replace. (Refer service section 6.3.4)</p>
FAN DOESN'T OPERATE	<p>Door not closed. <i>(Fan only operates with door closed).</i></p> <p>Door microswitch out of adjustment. (Refer fault diagnosis 6.1.2)</p> <p>Door microswitch faulty (Refer fault diagnosis 6.1.2)</p> <p>Fan motor faulty. (Refer fault diagnosis 6.1.2)</p> <p>Wiring.</p>	<p>Close door.</p> <p>Adjust. (Refer service section 6.4.2)</p> <p>Replace. (Refer service section 6.3.2)</p> <p>Replace. (Refer service section 6.3.15)</p> <p>Check and tighten any loose wiring.</p>
OVEN LIGHT NOT ILLUMINATING - DOOR OPEN	<p>Blown bulb.</p> <p>No power to light. (Refer fault diagnosis 6.1.3)</p>	<p>Replace. (Refer service section 6.3.1)</p>
OVEN LIGHT NOT ILLUMINATING - DOOR CLOSED	<p>Blown bulb.</p> <p>Light switch faulty. (Refer fault diagnosis 6.1.4)</p>	<p>Replace. (Refer service section 6.3.1)</p> <p>Replace. (Refer service section 6.3.4)</p>
NO WATER INJECTION / STEAM	<p>Water not turned on.</p> <p>Oven water nozzle blocked.</p> <p>Fault with water valve. (Refer fault diagnosis 6.1.5)</p> <p>Steam switch faulty.</p>	<p>Turn water on at water supply.</p> <p>Remove, clean or replace. (Refer service section 6.3.13)</p> <p>Service or replace as required. (Refer service section 6.3.11, 6.3.12)</p> <p>Replace. (Refer service section 6.3.4)</p>

FAULT	POSSIBLE CAUSE	REMEDY
CONTINUOUS WATER OUT OF OVEN WATER NOZZLE	With oven on only—Electrical fault. (Refer fault diagnosis 6.1.6) With oven on or off—Fault with water valve.	Correct electrical fault. Service or replace as required. (Refer service section 6.3.11, 6.3.10)
60 MINUTE TIMER WILL NOT TIME DOWN	Timer faulty.	Replace. (Refer service section 6.3.6)
60 MINUTE TIMER INACCURATE BELOW 20 MINUTES	Timer not set correctly. Zero (time up) position not set correctly.	For timer settings below 20 minutes, always rotate past 20 minutes, then back to desired time. (Refer service section 6.4.5)
60 MINUTE TIMER NO TIME UP BUZZER	Buzzer faulty. (Refer fault diagnosis 6.1.7) Timer not switching on buzzer. (Refer fault diagnosis 6.1.7)	Replace. (Refer service section 6.3.5) Replace. (Refer service section 6.3.6)
60 MINUTE TIMER NO TIME UP INDICATOR	Indicator faulty. (Refer fault diagnosis 6.1.8)	Replace. (Refer service section 6.3.3)
NO HEAT	No power to thermostat. (Refer fault diagnosis 6.1.9) Thermostat faulty (Refer fault diagnosis 6.1.9)	Identify fault and correct. Replace. (Refer service section 6.3.8)
NO TEMPERATURE CONTROL	Thermostat faulty (Refer fault diagnosis 6.1.10)	Replace. (Refer service section 6.3.8)
SLOW RECOVERY	Oven in 'Roast 'n Hold' mode. Overloading of oven. Electrical supply incorrect. Fan not working. Thermostat calibration. (Refer fault diagnosis 6.1.11) Element(s) not working.	Switch off 'Roast 'n Hold'. Reduce oven loading. Check supply voltage is as per rating plate voltage. Check fan operation. Correct calibration. (Refer service section 6.4.1) Correct element fault. (Refer Fault: Top element, Fault: Bottom element)
BOTTOM ELEMENT NOT WORKING	Element faulty (blown). (Refer fault diagnosis 6.1.12)	Replace. (Refer service section 6.3.14)
TOP ELEMENT NOT WORKING (IN BAKE MODE—NOT GRILL / BROIL MODE)	Element faulty / blown. (Refer fault diagnosis 6.1.13)	Replace. (Refer service section 6.3.14)

FAULT	POSSIBLE CAUSE	REMEDY
NO THERMOSTAT HEATING INDICATOR	Indicator faulty. (Refer fault diagnosis 6.1.14)	Replace. (Refer service section 6.3.3)
GRILL NOT WORKING	Element faulty / blown. (Refer fault diagnosis 6.1.15)	Replace. (Refer service section 6.3.14)
GRILL INDICATOR LIGHT NOT WORKING	Indicator faulty. (Refer fault diagnosis 6.1.16)	Replace. (Refer service section 6.3.3)
ROAST TIMER (180 MINUTE) WILL NOT TIME DOWN	Roast 'n' Hold switch not depressed. No power to timer / timer faulty. (Refer fault diagnosis 6.1.17)	Depress switch. Switch will illuminate. Correct electrical fault / replace timer. (Refer service section 6.3.7)
NO HOLD INDICATOR	'Roast 'n Hold' switch faulty. (Refer fault diagnosis 6.1.17) Faulty indicator. (Refer fault diagnosis 6.1.18) Faulty timer. (Refer fault diagnosis 6.1.18)	Replace. (Refer service section 6.3.4) Replace. (Refer service section 6.3.3) Replace. (Refer service section 6.3.7)
HOLDING TEMPERATURE INCORRECT	Hold thermostat set temperature incorrect Hold thermostat faulty. (Refer fault diagnosis 6.1.19)	Adjust to correct temperature. (Refer service section 6.4.4) Replace. (Refer service section 6.3.9)
DOOR DOES NOT CLOSE	Tray in way of door. Door seal obstruction. Door handle installed incorrectly. Door ball catch setting incorrect. Door pivot bushes / pins worn.	Correctly position tray in rack. Correctly install door seal. (Refer service section 6.3.20) Fit correctly. (Refer installation section) Adjust. (Refer service section 6.4.3) Replace. (Refer service section 6.3.21)
DOOR SEAL LEAKS	Door seal damaged. Door seal incorrectly fitted. Door ball catch setting incorrect. Door pivot bushes / pins worn.	Replace. (Refer service section 6.3.20) Correctly install door seal. (Refer service section 6.3.20) Adjust. (Refer service section 6.4.3) Replace. (Refer service section 6.3.21)

6. SERVICE PROCEDURES



WARNING: ENSURE POWER SUPPLY IS SWITCHED OFF BEFORE SERVICING.



WARNING: ALL INSTALLATION AND SERVICE REPAIR WORK MUST BE CARRIED OUT BY QUALIFIED PERSONS ONLY.

SECTION	PAGE NO.
6.1 FAULT DIAGNOSIS	19
6.1.1 Oven Does Not Operate / Start.....	19
6.1.2 Fan Does Not Operate.....	19
6.1.3 Oven Light Not Illuminating—Door Open	19
6.1.4 Oven Light Not Illuminating—Door Closed	19
6.1.5 No Water Injection / Steam.....	19
6.1.6 Continuous Water Out Of Oven Water Nozzle	20
6.1.7 60 Minute Timer No Time Up Buzzer	20
6.1.8 60 Minute Timer No Time Up Indicator.....	20
6.1.9 No Heat.....	20
6.1.10 No Temperature Control	21
6.1.11 Slow Recovery	21
6.1.12 Bottom Element Not Working	21
6.1.13 Top Element Not Working (In Bake Mode—Not Grill / Broil).....	21
6.1.14 No Thermostat Heating Indicator.....	21
6.1.15 Grill Not Working.....	21
6.1.16 Grill Indicator Not Working.....	22
6.1.17 Roast Timer (180 Minute) Will Not Time Down	22
6.1.18 No Hold Indicator	22
6.1.19 Holding Temperature Incorrect.....	22
6.2 ACCESS	23
6.2.1 Control Panel	23
6.2.2 Service Panel (Rear Panel)	23
6.2.3 Baffle.....	23
6.2.4 Control Panel (Rear).....	23
6.3 REPLACEMENT	24
6.3.1 Light Bulb / Glass.....	24
6.3.2 Door Microswitch	24
6.3.3 Indicator Neon Light.....	24
6.3.4 Power / Roast / Lights / Water Switches.....	24
6.3.5 Buzzer.....	24
6.3.6 Bake Timer.....	25
6.3.7 Roast Timer.....	25
6.3.8 Thermostat.....	25
6.3.9 Hold Thermostat	26
6.3.10 Mini-Contactor.....	26
6.3.11 Water Solenoid	26
6.3.12 Water Solenoid Cleaning	27
6.3.13 Spray Nozzle.....	27
6.3.14 Elements	27

6.3.15	Fan	27
6.3.16	Motor	28
6.3.17	Outer Glass	28
6.3.18	Inner Glass	29
6.3.19	Inner Glass Seal	29
6.3.20	Door Seals	29
6.3.21	Door Pivot Bushes	29
6.4	ADJUSTMENT / CALIBRATION	30
6.4.1	Thermostat Calibration	30
6.4.2	Door Microswitch Adjustment	31
6.4.3	Door Alignment	31
6.4.4	Hold Temperature Adjustment	31
6.4.5	60 Minute Timer Zero Position Adjustment	31

6.1 FAULT DIAGNOSIS

6.1.1 OVEN DOES NOT OPERATE / START

Incorrect electrical supply

Check that the voltage across phase and neutral (L1 and L2) terminals of terminal block is the voltage as stated on the unit's electrical rating plate.

If incorrect, check electrical connection of supply wiring and / or check electrical supply.

Power switch faulty

Check if power switch latches. If the switch does not latch, then switch is faulty—replace.

With switch latched, check voltage across terminal one to terminal three or four. If there is no voltage, check for fault in wiring.

Check voltage across terminal two to terminal three or four. If there is no voltage, then switch is faulty—replace.

NOTE: When power switch is latched, it should illuminate if operating correctly.

6.1.2 FAN DOESN'T OPERATE

Microswitch out of adjustment

Open oven door and manually depress door microswitch actuator at top right of oven. If this activates the fan, then the microswitch actuator arm at rear of oven requires adjustment.

Microswitch faulty

Check voltage across microswitch terminals to neutral.

With the door closed there should be power to the com terminal and the n.o. terminal.

With the door open there should be power to the com terminal and the n.c. terminal.

If not, microswitch is faulty—replace.

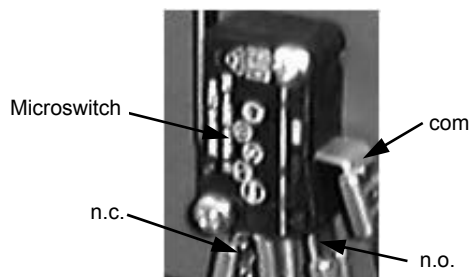

Figure 6.1.1

Fan motor faulty

Check the supply voltage across motor terminals. If there is no voltage then check the electrical connections of supply wiring.

If voltage is correct then check the oven fan for free rotation. Remove any obstruction.

If fan is free to spin and the voltage supply is correct, then the motor is faulty—replace.

6.1.3 OVEN LIGHT NOT ILLUMINATING—DOOR OPEN

No power to light

Check the supply voltage across lamp housing terminals at rear of oven. If the voltage is correct, replace the bulb (if faulty). If the bulb is OK, check lamp housing. Replace if faulty.

If there is no voltage, open oven door and manually depress door microswitch actuator at top right of oven. If this activates the fan, then the microswitch actuator arm at rear of oven requires adjustment.

Check voltage across micro-switch terminals to neutral.

With the door closed there should be power to the com terminal and the n.o. terminal.

With the door open there should be power to the com terminal and the n.c. terminal.

If not, microswitch is faulty—replace.

6.1.4 OVEN LIGHT NOT ILLUMINATING—DOOR CLOSED

Light switch faulty

Check voltage to the bottom terminal of the switch. If there is no voltage, then check wiring.

With switch depressed, check voltage at top terminal. If there is no voltage, then replace the switch.

If voltage is correct, then check wiring to light.

NOTE: Alternately, perform a continuity test across the terminals with the light switch depressed.

6.1.5 NO WATER INJECTION / STEAM

Fault with water valve

Check voltage supply across the water valve solenoid coil with the steam switch depressed. If there is no power supply then check the control panel steam switch.

Check voltage to the bottom terminal of the switch. If there is no voltage, then check wiring.

With switch depressed, check for voltage at top terminal. If there is no voltage then replace switch. If voltage correct, check wiring to solenoid coil.

If the power supply to the coil is correct, disconnect wiring to coil and check the resistance of the coil windings.

Correct coil resistance: 2500 ohms

NOTE: If open circuit / high resistance, then the coil is faulty—replace.

If coil resistance is correct, rewire and listen for an audible solenoid click when the steam switch is depressed.

If solenoid can be heard functioning, and oven water nozzle is not blocked, then remove water solenoid and fittings and check for blockages.

6.1.6 CONTINUOUS WATER OUT OF OVEN WATER NOZZLE

Water solenoid electrical fault

With control panel steam switch not depressed, check for power supply across solenoid coil. If there is power to the coil, then check wiring and steam switch (refer 6.1.5).

6.1.7 60 MINUTE TIMER NO TIME UP BUZZER

Buzzer faulty

With timer in 'zero' position, check the buzzer at top of control panel (inside) for voltage across terminals. If voltage is correct then buzzer is faulty—replace.

If there is no voltage, then check wiring.

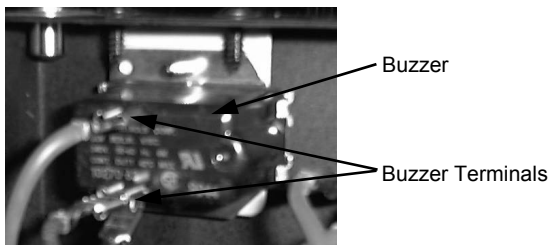

Figure 6.1.2

Timer not switching on buzzer

With timer in zero position, check voltage to top connection (terminal 1) and bottom connection (terminal 2) of timer. If there is no voltage at terminal 1 then check wiring.

If no voltage at terminal 2 then timer is faulty—replace.

NOTE: Timer will continue to run for approximately three minutes below zero. Buzzer and time up indicator will continue until the timer manually switched off (to vertical position).

6.1.8 60 MINUTE TIMER NO TIME UP INDICATOR

Indicator faulty

With the timer in the zero position, check for voltage across the indicator light. If correct, then the indicator light is faulty—replace.

If there is no voltage then check wiring.

6.1.9 NO HEAT

No power to thermostat

Check voltage to terminal 1 on oven thermostat. If there is no voltage then check voltage through terminal 21 and 22 on mini contactor (inside control panel). If there is no voltage to terminal 21 then check wiring. If there is no voltage to terminal 22 then check that the contact indicator on centre of the contactor is in '0' position. If indicator is in '0' position and there is no voltage to 21 then replace contactor.

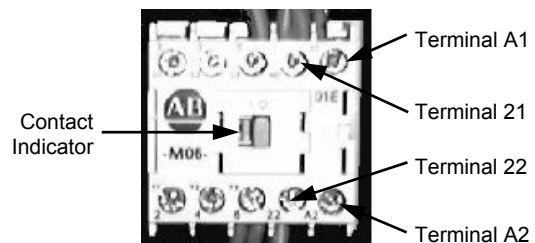

Figure 6.1.3

If indicator is in the '1' position then check the voltage across contactor coil terminals A1 and A2.

NOTE: There should be no voltage across these terminals when 'Roast 'n Hold' is not selected.

If the indicator is in position '1' with no voltage across A1 and A2 then the contactor is faulty—replace.

Thermostat faulty

Set thermostat to 200°C or 400°F. Check the voltage out of terminal two on the thermostat. If there is no voltage then the thermostat is faulty—replace.

If the voltage is correct and the heating light is on then check all wiring to elements.

6.1.10 NO TEMPERATURE CONTROL

Thermostat faulty

With thermostat in off (vertical) position, the heating indicator should be off. If not then the thermostat is faulty—replace.

Check that the thermostat phial is in correct location and check for broken capillary tube—replace if damaged.

Place an accurate digital thermometer probe in centre of oven. Set thermostat to 180°C or 355°F. Close the oven door and allow oven thermostat to regain temperature. If temperature overshoots by 50°C and continues, switch off and replace.

6.1.11 SLOW RECOVERY

Thermostat out of calibration

Place an accurate digital thermometer probe in centre of oven. Set thermostat to 180°C or 355°F. Close the oven door and allow oven thermostat to cycle on and off twice. Record oven centre temperature for the next thermostat on and off cycle. The thermostat should cycle on and off between 165°C and 195°C or 330°F and 385°F when set to the above temperature. If oven temperature is outside these ranges, then the thermostat requires recalibration.

NOTE: Thermostat cycling span should be $\pm 15^{\circ}\text{C}$ or 27°F

6.1.12 BOTTOM ELEMENT NOT WORKING

Element faulty (blown)

With the thermostat on and heating check voltage across bottom element terminals at rear of oven. If the voltage is correct then check the current draw of element. If there is no current draw then element is faulty—replace.

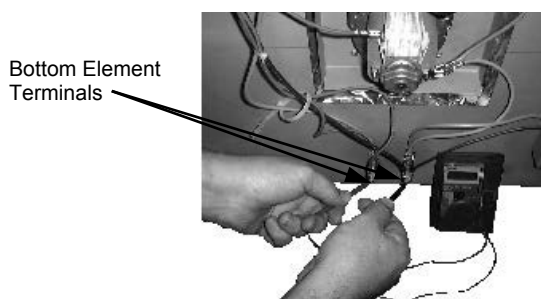

Figure 6.1.4

If there is no voltage then check voltage is being supplied to bottom element from terminal 6 on switch block mounted to the front of the thermostat (fig 6.4.1). If no voltage at 6

then check for voltage at terminal P6. If power to P6 (and none to 6), then the thermostat is faulty—replace.

NOTE: Correct bottom element current draw:

208 V : 9.6A \pm 5%
220—240V: 8.7A \pm 5%

6.1.13 TOP ELEMENT NOT WORKING (IN BAKE MODE—NOT GRILL / BROIL)

Element faulty / blown

NOTE: In bake mode (50—270°C or 100—550°F) the outer coil only of the top element assembly operates. The inner coil works only when in grill or broil mode.

With thermostat on and heating check voltage across top element terminals at rear of oven. If voltage is correct then check current draw of the element. If there is no current draw then the element is faulty—replace.

If there is no voltage check voltage is being supplied to the top element from terminal two on the switch block mounted to front of thermostat.

If voltage is correct then check wiring.

NOTE: Top outer element current draw:

208V : 3.8A \pm 5%
220—240V: 3.5A \pm 5%

6.1.14 NO THERMOSTAT HEATING INDICATOR

Indicator faulty

Check the voltage across the indicator terminals. If the voltage is correct then the indicator is faulty—replace.

If there is no voltage then check wiring.

6.1.15 GRILL NOT WORKING

Element faulty / blown

With thermostat in grill or broil position (fully clockwise), check that the grill indicator on the control panel indicates. If not, then check the voltage at terminal P5 on the thermostat switch (fig 6.4.1). If there is no voltage check that the switch has power on terminal 5. If there is power at terminal 5, but not at P5 when thermostat is in grill position, then the switch is faulty—replace thermostat assembly.

If grill indicator is illuminated, but the top inner grill element is not functioning, check the voltage at the top inner element coils at rear of oven. If the voltage is correct then check current draw of element. If there is no current draw then element is faulty—replace.

NOTE: Top inner element current draw:

208 V: 8.7A ± 5%
220—240 V: 7.8A ± 5%

6.1.16 GRILL INDICATOR NOT WORKING

Indicator faulty

Check the voltage across the indicator terminals. If the voltage is correct then indicator is faulty—replace.

If there is no voltage then check wiring.

6.1.17 ROAST TIMER (180 MINUTE) WILL NOT TIME DOWN

No power to timer

Check the voltage at terminal 5 on underside of the 180 minute timer.

Check that one lead of timer motor is connected to terminal 5 of timer and the other lead is connected to neutral of 'Roast 'n Hold' switch.

If voltage at terminal 5 is correct and wiring is correct then the timer motor is faulty—replace timer.

If there is no power at terminal 5 check for power supply at terminal 4 of timer. If there is voltage at terminal 4 and not at terminal 6 with timer set, then timer switch is faulty—replace timer.

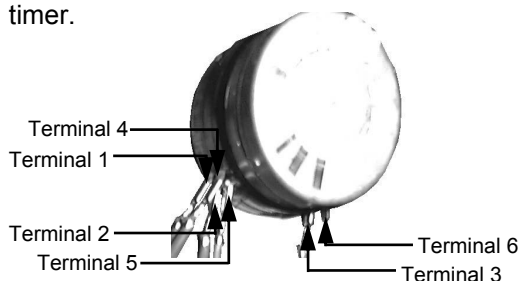

Figure 6.1.5

If terminal 4 voltage is correct, check mini contactor behind control panel is latched to the '1' position. If contactor is in '1' position then check wiring.

If contactor is in '0' position when 'Roast 'n Hold' switch illuminated then check the voltage across terminals A1 and A2 of mini contactor (fig 6.1.3). If the voltage is correct but the contactor in the off ('0') position then the contactor is faulty—replace.

If there is no voltage across A1 and A2 then check wiring.

'Roast 'n Hold' switch faulty

Check if the switch latches. If the switch does not latch then the switch is faulty—replace.

With the switch latched, check voltage across

terminal 1 to terminal 3 or 4. If there is no voltage then check for fault in wiring.

Check voltage across terminal 2 to terminal 3 or 4. If there is no voltage then switch is faulty—replace.

NOTE: When the switch is latched, it should illuminate if operating correctly.

6.1.18 NO HOLD INDICATOR

Indicator faulty

Check the voltage across the indicator terminals. If the voltage is correct then the indicator is faulty—replace.

If there is no voltage then check wiring.

Timer faulty

Check the voltage at terminal 3 of timer, with timer in hold position. If the voltage is correct then check wiring.

If there is no voltage then check voltage at terminal 1 of timer. If there is voltage at 1, but no voltage at terminal 3 with timer in hold position, then timer switch is faulty—replace.

6.1.19 HOLDING TEMPERATURE INCORRECT

Hold thermostat faulty

With the power switch on and illuminated, 'Roast 'n Hold' switch on and illuminated, and the roast (180 minute) timer set to hold, check that the hold indicator is illuminated.

With a cold oven (ie room temperature) check that the top outer and bottom oven elements only are heating. Test the voltage across the bottom element and top element terminals at the rear of oven. If the voltage is correct then refer Fault: Bottom element not working (trouble shooting section).

NOTE: If the main thermostat is set to off (vertical) position and 'Roast 'n Hold' mode is selected, then only the bottom element will heat.

If there is no voltage at the element terminals, check the voltage at terminal 2 (top) of the hold thermostat at bottom rear of control panel (fig 6.3.12). If there is no voltage then check wiring.

If the voltage is correct, and the thermostat is adjusted above oven temperature, then check for output voltage at terminal 1 (bottom). If there is no voltage and the thermostat will not switch on then the thermostat is faulty—replace.

If the voltage is correct but the bottom element is not working then check wiring.

6.2 ACCESS

6.2.1 CONTROL PANEL

- 1) Open the oven door. Remove microswitch button by pulling straight off.
- 2) Undo the two screws now visible.



Figure 6.2.1

- 3) Panel is now free to hinge along right hand side. When closing the panel ensure wires and capillary tube are clear of metal or other terminals.



Figure 6.2.2

6.2.2 SERVICE (REAR) PANEL

- 1) Undo the four screws holding the panel.

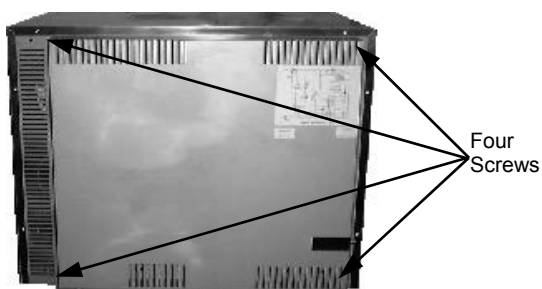

Figure 6.2.3

- 2) Remove panel.

6.2.3 BAFFLE

- 1) Remove trays, racks, element cover and left hand side rack.
- 2) Undo lamp cover.

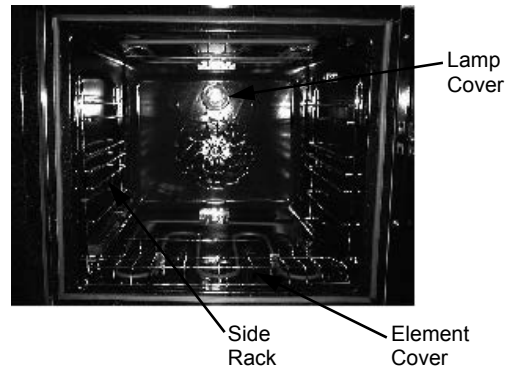

Figure 6.2.4

- 3) Remove baffle.

6.2.4 CONTROL PANEL—REAR

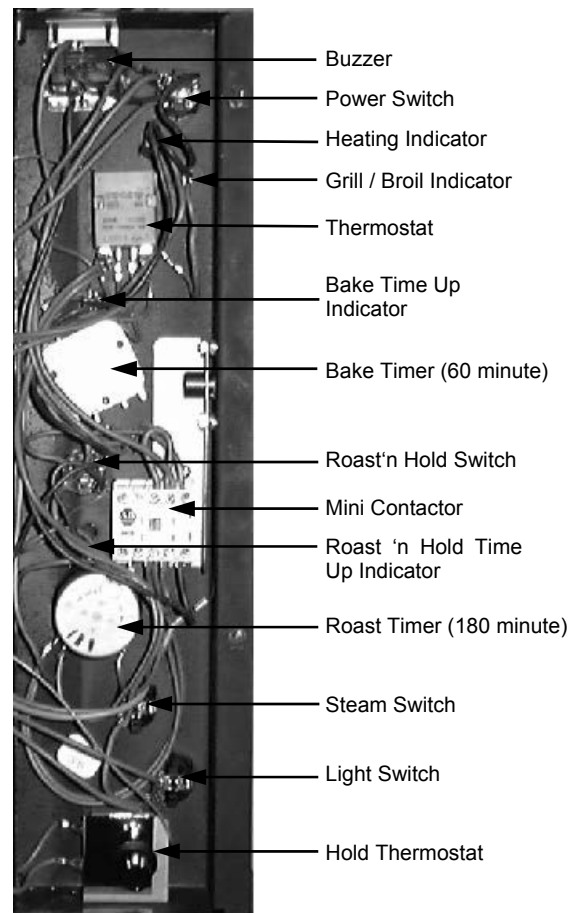

Figure 6.2.5

6.3 REPLACEMENT

6.3.1 LIGHT BULB / GLASS

- 1) Unscrew lamp cover.



Figure 6.3.1

- 2) Unscrew bulb out of fitting.
- 3) Screw in replacement bulb.
- 4) Ensure seal fitted. Screw lamp cover into holder with baffle fitted (do not over tighten).

6.3.2 DOOR MICROSWITCH

- 1) Remove service panel (refer 6.2.2).
- 2) Remove two screws holding microswitch to bracket.

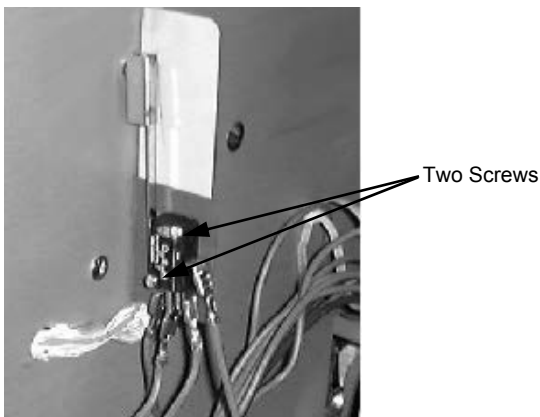

Figure 6.3.2

- 3) Transfer wires to new micro-switch and re-assemble.
- 4) Adjust microswitch (refer 6.4.2).

6.3.3 INDICATOR NEON LIGHT

- 1) With control panel open (refer 6.2.1) remove the wires from the back of the neon.

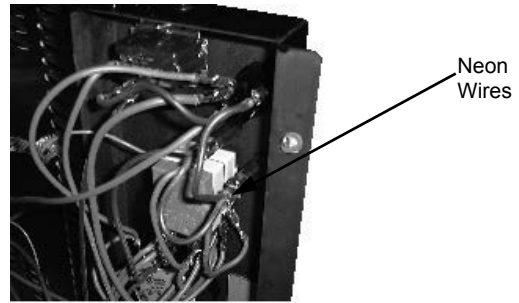

Figure 6.3.3

- 2) From back push neon through front of panel rotating clockwise.
- 3) Push new neon in from front of panel, and reconnect wires.

6.3.4 POWER / ROAST / LIGHTS / WATER SWITCHES

- 1) With control panel open (refer 6.2.1) remove the wires from the back of the switch, noting their positions.

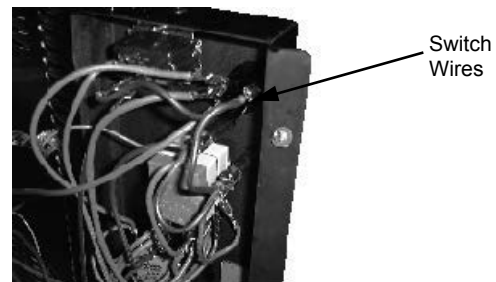

Figure 6.3.4

- 2) From back push switch through front of panel.
- 3) Push new switch in from front of panel, and reconnect wires.

6.3.5 BUZZER

- 1) Remove control panel (refer 6.2.1).
- 2) Remove two screws holding buzzer bracket to panel.

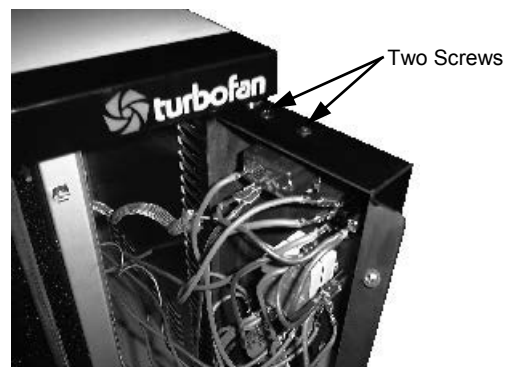

Figure 6.3.5

- 3) Withdraw and remove two screws holding buzzer to bracket.

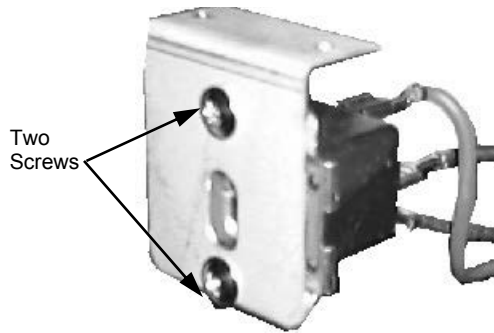

Figure 6.3.6

- 4) Transfer wires to new buzzer.
- 5) Reassemble in reverse order.

6.3.6 BAKE TIMER

- 1) Remove bake timer knob by pulling it firmly away from control panel.
- 2) Open control panel (refer 6.2.1) and undo two screws securing timer.

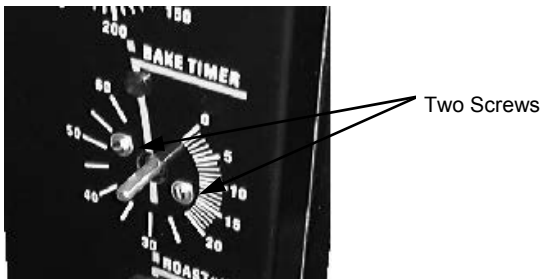

Figure 6.3.7

- 3) Transfer wires to new timer.
- 4) Withdraw old timer and insert new timer, securing with screws.
- 5) Replace knob.

6.3.7 ROAST TIMER

- 1) Remove roast timer knob by pulling it firmly away from control panel.
- 2) Open control panel (refer 6.2.1) and undo two screws securing timer.

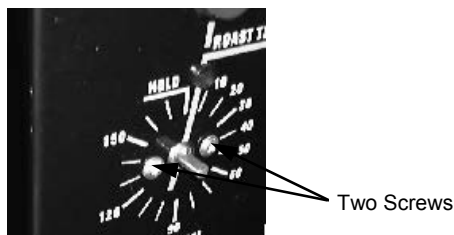

Figure 6.3.8

- 3) Transfer wires to new timer.
- 4) Withdraw old timer and insert new timer, securing with screws.
- 5) Replace knob.

6.3.8 THERMOSTAT

- 1) Pull knob off front of thermostat
- 2) Open control panel (refer 6.2.1) and undo two screws securing thermostat.

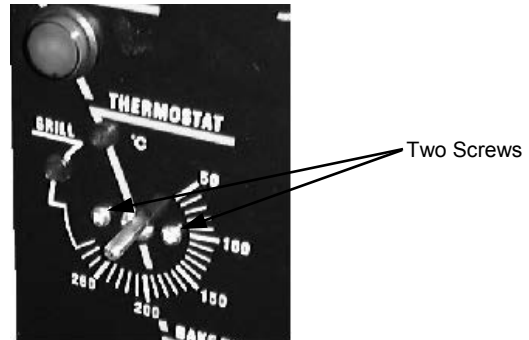

Figure 6.3.9

- 3) Transfer wires to new thermostat.
- 4) Remove service panel (refer 6.2.2) and from inside of oven loosen two screws holding thermostat phial bracket.



Figure 6.3.10

- 5) Withdraw old thermostat phial through rear of oven.
- 6) Remove fibreglass sleeve from old thermostat and fit it to replacement thermostat.

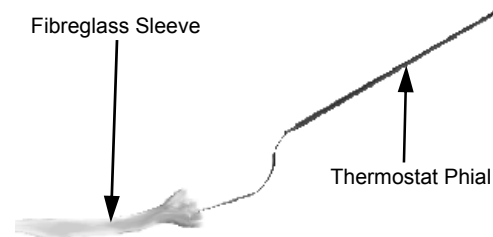

Figure 6.3.11

- 7) Insert new thermostat.
- 8) Re-assemble in reverse order.

6.3.9 HOLD THERMOSTAT

- 1) Open control panel (refer 6.2.1) and undo two screws securing hold thermostat bracket.

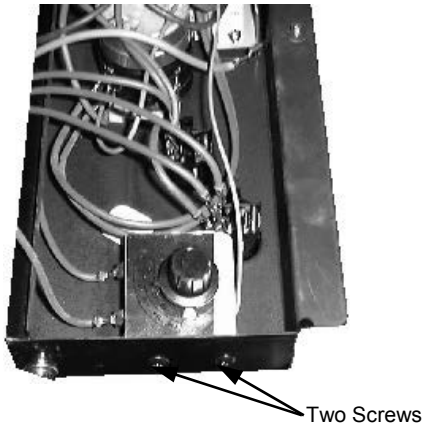

Figure 6.3.12

- 2) Transfer wires to new thermostat.
- 3) Remove service panel (refer 6.2.2) and from inside of oven loosen the thermostat phial bracket.



Figure 6.3.13

- 4) Withdraw old thermostat phial through rear of oven.
- 5) Insert new thermostat.
- 6) Re-assemble in reverse order.

6.3.10 MINI-CONTACTOR

- 1) Open control panel (refer 6.2.1) and transfer wires from old mini-contactor to new contactor.
- 2) Remove two screws securing old mini-contactor to control panel.

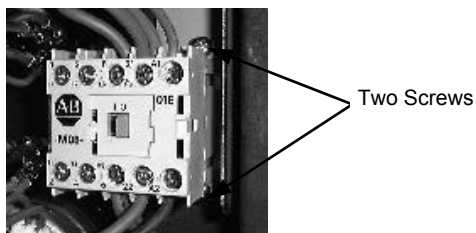

Figure 6.3.14

- 3) Secure new mini-contactor to control panel using two screws.

6.3.11 WATER SOLENOID

- 1) Ensure water supply is turned off.
- 2) Inside the oven remove the baffle (refer 6.2.3), then unscrew the water injection nozzle.

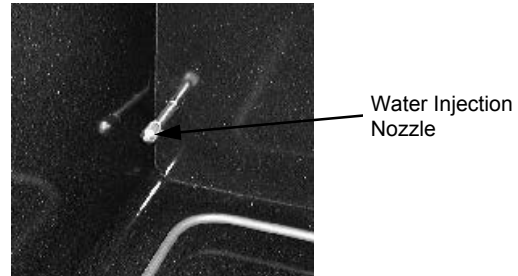

Figure 6.3.15

- 3) With the service panel removed (refer 6.2.2) remove the wires from the solenoid.
- 4) Disconnect hose fitting.
- 5) Unscrew the three screws holding solenoid bracket to the rear of unit and remove valve assembly.

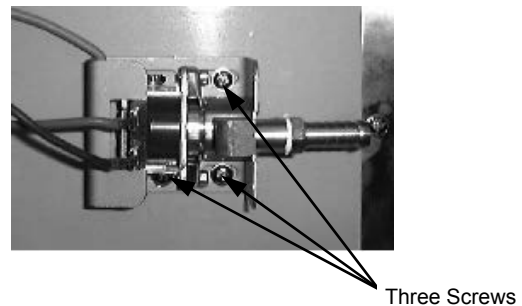

Figure 6.3.16

- 6) On suitable work surface, remove brass piping connections (1/2" spanner) and two screws (on bracket) and extract solenoid.

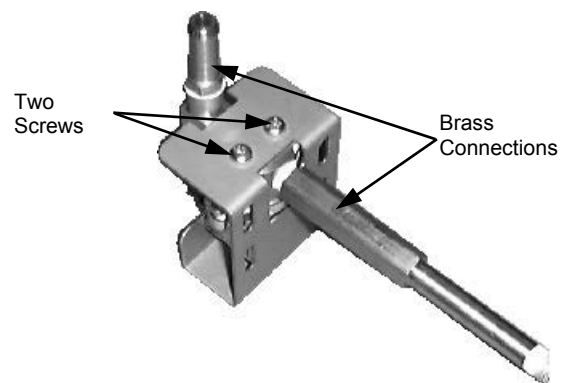

Figure 6.3.17

- 7) Secure new solenoid with screws, and re-assemble. Check that flow direction as marked on valve is correct (flow into spray nozzle).

6.3.12 WATER SOLENOID CLEANING

- 1) Remove water solenoid (refer 6.3.10).
- 2) Remove the two screws securing the bracket to the solenoid.

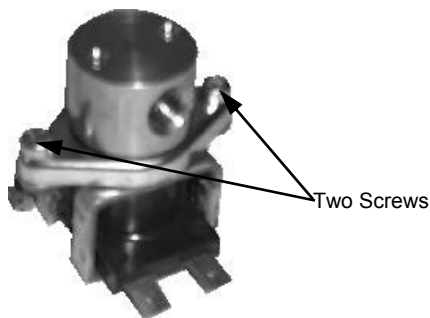

Figure 6.3.18

- 3) Remove the valve assembly.



Figure 6.3.19

- 4) Clean the valve assembly, removing all dirt and grime from the valve seat.
- 5) Reassemble the valve assembly and solenoid.

6.3.13 SPRAY NOZZLE

- 1) Inside the oven remove the LH side rack and baffle (refer 6.2.3), then unscrew the water injection nozzle.

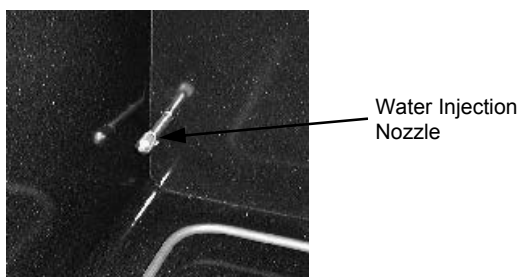

Figure 6.3.20

- 2) Clean or replace as required, ensuring debris free on re-assembly.

6.3.14 ELEMENTS

- 1) With service panel and baffle removed (refer 6.2.2 and 6.2.3) remove the wires from the element(s).

- 2) Unscrew the element from inside the oven.

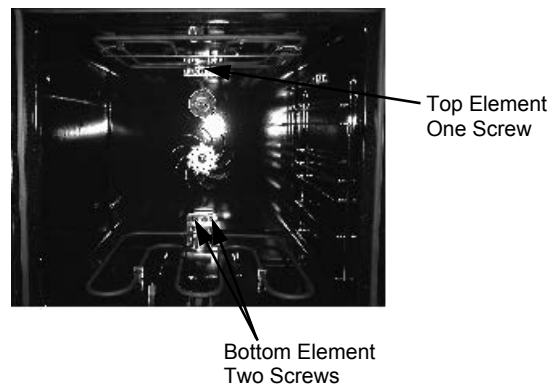

Figure 6.3.21

- 3) Pull element carefully to remove.
- 4) Replace and re-assemble in reverse order.

Element Ratings $\pm 5\%$

208 V	Top Inner Element	24.5 ohms
	Top Outer Element	55.3 ohms
	Bottom Element	22.5 ohms
220—240V	Top Inner Element	29.5 ohms
	Top Outer Element	66.5 ohms
	Bottom Element	27.3 ohms

6.3.15 FAN

- 1) With service panel and baffle removed (refer 6.2.2 and 6.2.3) undo the centre nut.

NOTE: LH thread - Turn clockwise to loosen.

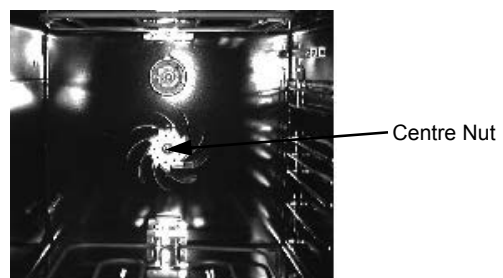

Figure 6.3.22

- 2) Replace and re-assemble in reverse order.

6.3.16 MOTOR

- 1) Remove fan (refer 6.3.14) and then remove the wires that go to the motor.
- 2) Undo the four screws holding the motor bracket in place (from the outside) and remove motor assembly.

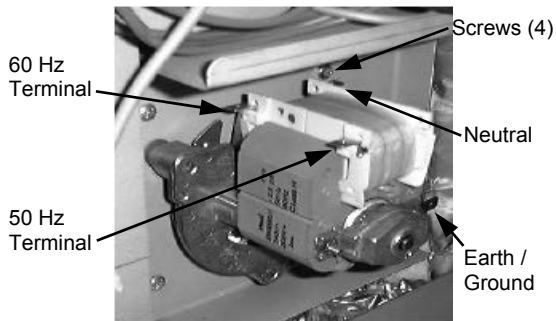

Figure 6.3.23

- 3) Remove three screws holding motor to bracket and remove motor.

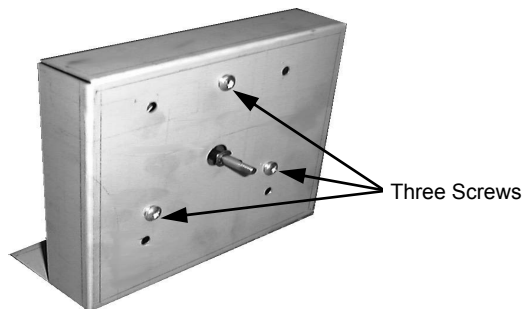

Figure 6.3.24

- 4) Replace and re-assemble in reverse order.
- 5) Ensure wire connections are correct to the voltage supply—60 Hz / 50 Hz (fig 6.3.23)

6.3.17 OUTER GLASS

- 1) Open door
- 2) Undo two screws securing Turbofan cover plate to oven, and remove cover plate.

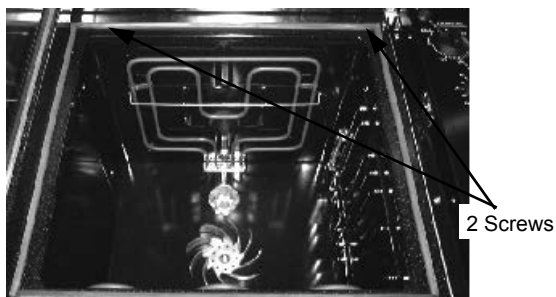

Figure 6.3.25

- 3) Remove LH screw whilst supporting the door. Lift bracket and remove door from oven.



Figure 6.3.26

- 4) Remove screws securing door handle.

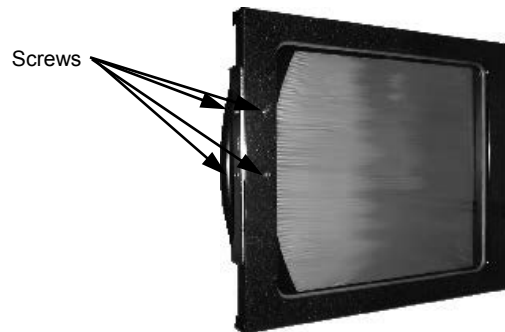

Figure 6.3.27

- 5) Remove two screws in top trim and two screws in bottom trim of door, and remove trim panels.

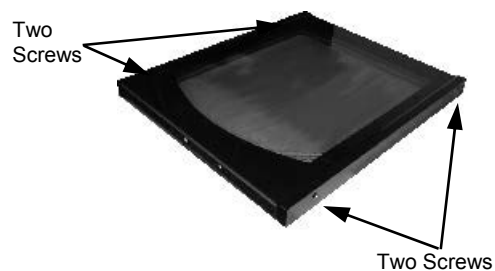

Figure 6.3.28

- 6) Lift outer glass away from door.
- 7) To replace, ensure that the two silicone rubber seals are in place on the left hand and right hand side of the door frame. Clean the inside of the glass and refit it, ensuring that the silicone rubber seals cover the outer edges of the glass. Refit the bottom trim.

6.3.18 INNER GLASS

- 1) Remove the outer glass as above. Uncrimp the retaining lugs of the window spacer and remove the spacer and glass.

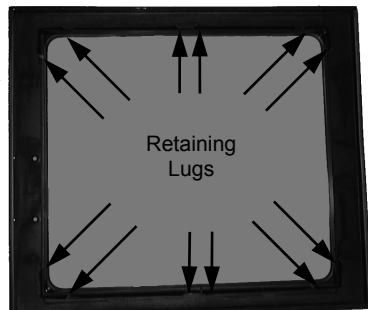

Figure 6.3.29

- 2) To replace, ensure the silicone rubber seal has not been displaced. Clean the glass and refit it. Place the window spacer in position and crimp the retaining lugs over to hold the glass in place. Refit outer glass as above.

6.3.19 INNER GLASS SEAL

- 1) Remove the door inner glass (refer 6.3.18).
- 2) The inner glass seal can now be removed and replaced.

NOTE: When fitting new seal, ensure join is at top of door.

6.3.20 DOOR SEALS

- 1) Open oven door.
- 2) To remove, hold at their centre point and pull forward until they unclip

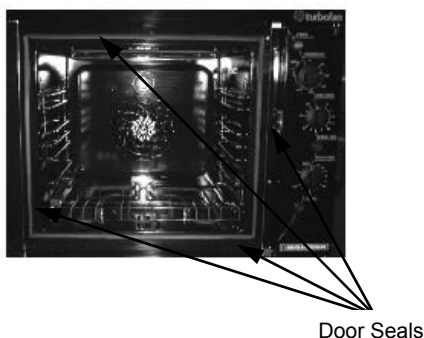

Figure 6.3.30

- 3) Refit new seals.

Note: Fit top and bottom seals first, with the open side of the seal facing downwards. Fit side seals with open side facing outwards.

6.3.21 DOOR PIVOT BUSHES

- 1) Remove door as per steps one to three of section 6.3.16.
- 2) Door bushes can now be removed and replaced.
- 3) Reinstall door by reversing steps one to three of section 6.3.16.

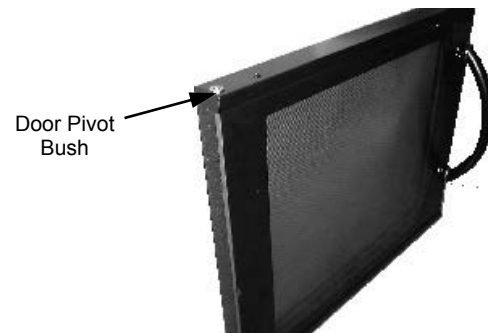

Figure 6.3.31

6.4 ADJUSTMENT / CALIBRATION

6.4.1 THERMOSTAT CALIBRATION

! **IMPORTANT:** IF THE OVEN TEMPERATURE NEEDS TO BE INCREASED, ENSURE THAT THE THERMOSTAT IS IN THE 'OFF' POSITION BEFORE CARRYING OUT ADJUSTMENT. IF OVEN TEMPERATURE NEEDS TO BE DECREASED, ENSURE THERMOSTAT IS IN THE 'MAX' TEMPERATURE POSITION BEFORE CARRYING OUT ANY ADJUSTMENT.

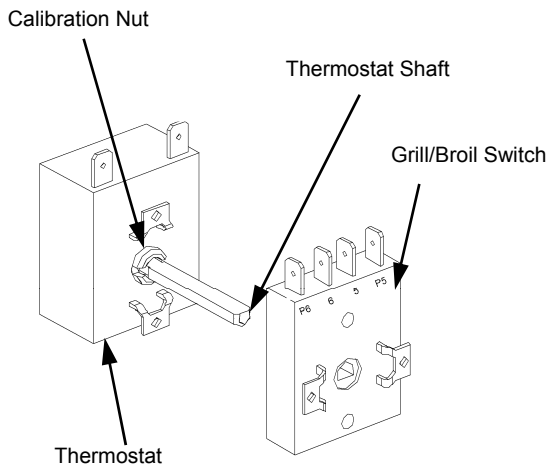

Figure 6.4.1

- 1) Turn off power.
- 2) Remove thermostat knob by pulling it firmly away from control panel.
- 3) Open control panel (refer 6.2.1). Remove two screws on control panel holding thermostat.

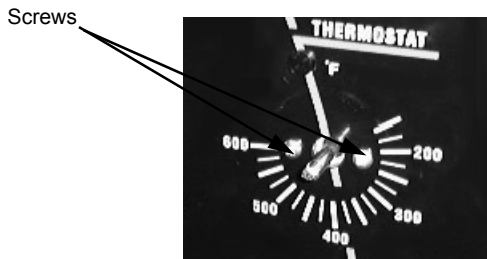

Figure 6.4.2

- 4) The thermostat can now be removed.

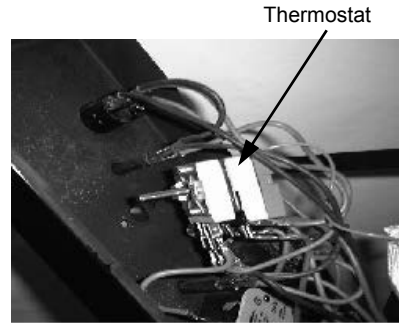

Figure 6.4.3

- 5) Carefully remove two screws holding Grill/Broil switch to thermostat.

HINT: Tape Grill/Broil switch assembly together before removal to prevent it from springing apart.

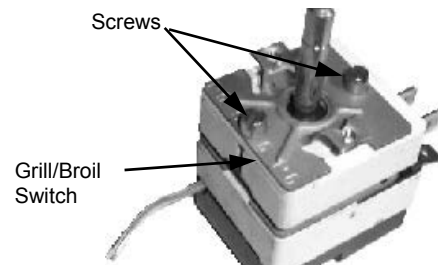

Figure 6.4.4

- 7) Adjust the calibration nut located at the base of the thermostat shaft. To increase oven temperature, turn calibration nut anticlockwise. To decrease oven temperature, turn calibration nut clockwise. Adjustment of the calibration nut by 1° angular will alter oven temperature by approximately 2°C (3.6°F).

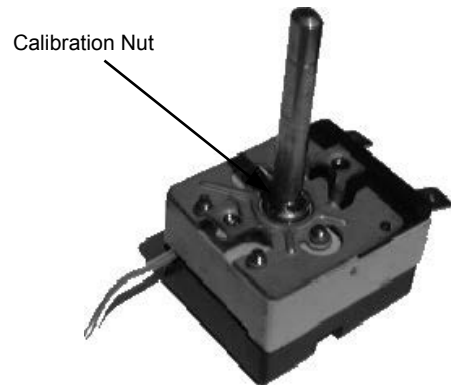

Figure 6.4.5

- 8) Reassemble Grill/Broil switch onto the thermostat and fit assembly back onto control panel.
- 9) Turn on power and recheck oven thermostat calibration.
- 10) Repeat procedure if necessary.

6.4.2 DOOR MICROSWITCH ADJUSTMENT

- 1) Open oven door.
- 2) Remove service panel (refer 6.2.2).
- 3) With fingers, bend actuator arm of microswitch so that switch operates when door is in closed position.

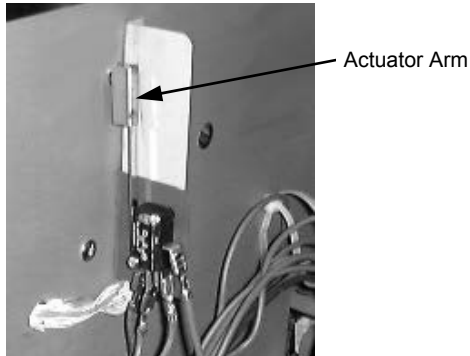

Figure 6.4.6

6.4.3 DOOR ALIGNMENT

- 1) Alignment of the door can be achieved by loosening the two hex head bolts securing the bottom plate to the oven body. The plate may now be moved sideways or in / out to achieve correct door alignment. (Door should be parallel to bottom plate and touching oven seal evenly). When correct tighten bolts.

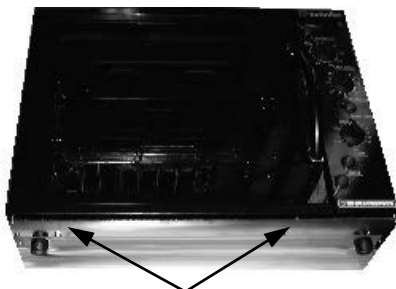

Figure 6.4.7

- 2) To adjust the door catch, loosen locknut and turn the slot (using the tool supplied with the unit); anticlockwise to increase roller height, clockwise to decrease roller height.

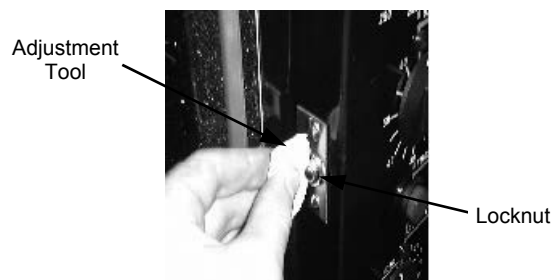

Figure 6.4.8

6.4.4 HOLD TEMPERATURE ADJUSTMENT

- 1) The hold temperature of the oven can be adjusted by turning the hold thermostat dial to the desired hold temperature. This dial is located inside the control panel.

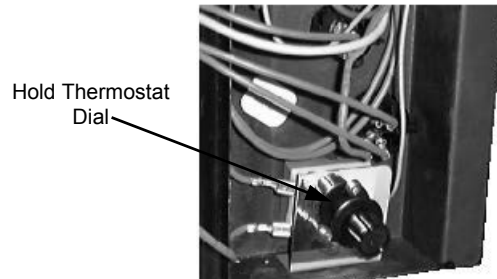

Figure 6.4.9

6.4.5 60 MINUTE TIMER ZERO POSITION ADJUSTMENT

- 1) Remove 60 minute timer knob by pulling it firmly away from control panel.
- 2) Open control panel (refer 6.2.1). Loosen two screws on control panel holding 60 minute timer.



Figure 6.4.10

- 3) The timer can now be rotated as required to ensure that the buzzer sounds at the zero position.

7. ELECTRICAL CIRCUIT SCHEMATIC

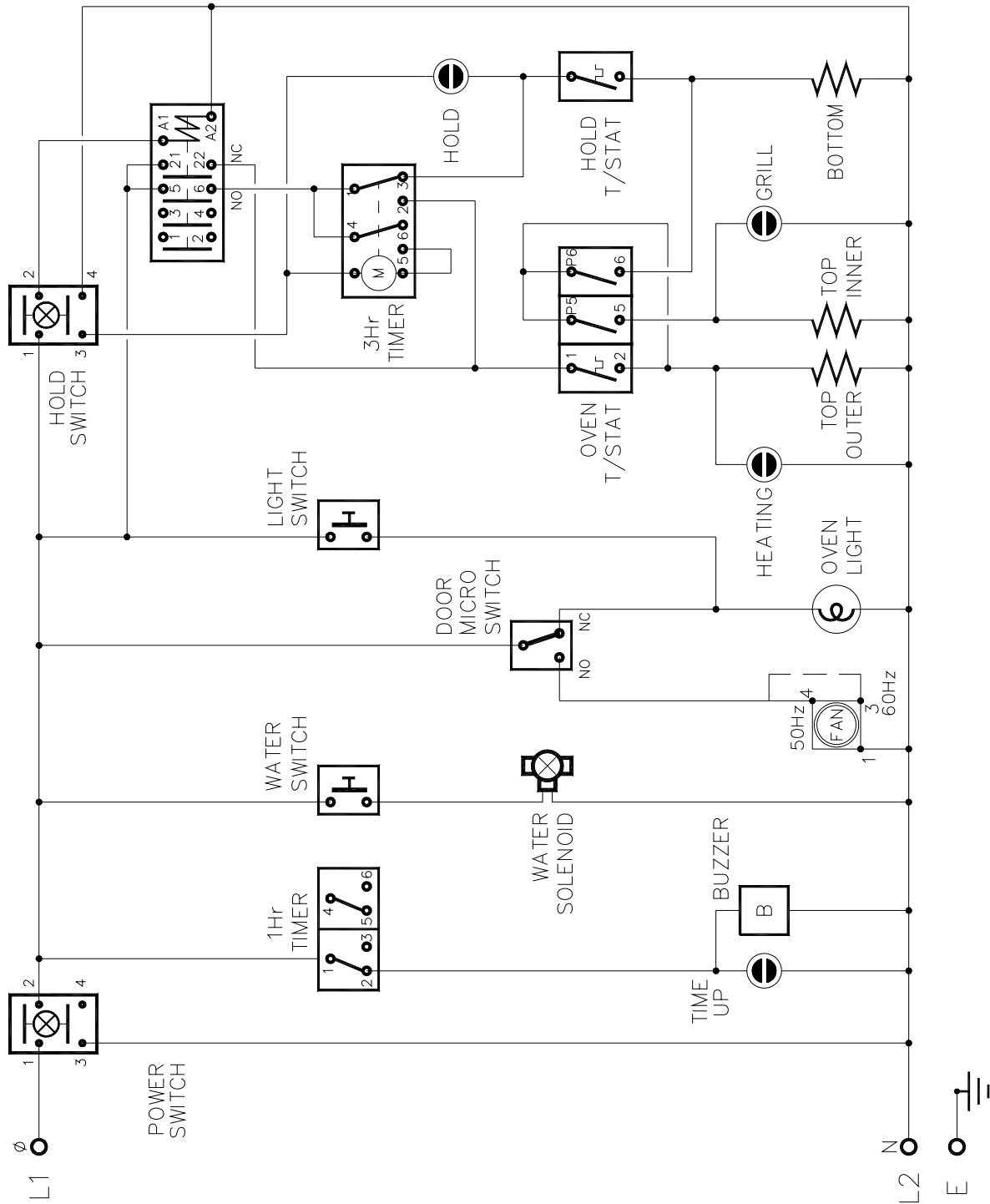

8. ELECTRICAL WIRING DIAGRAM

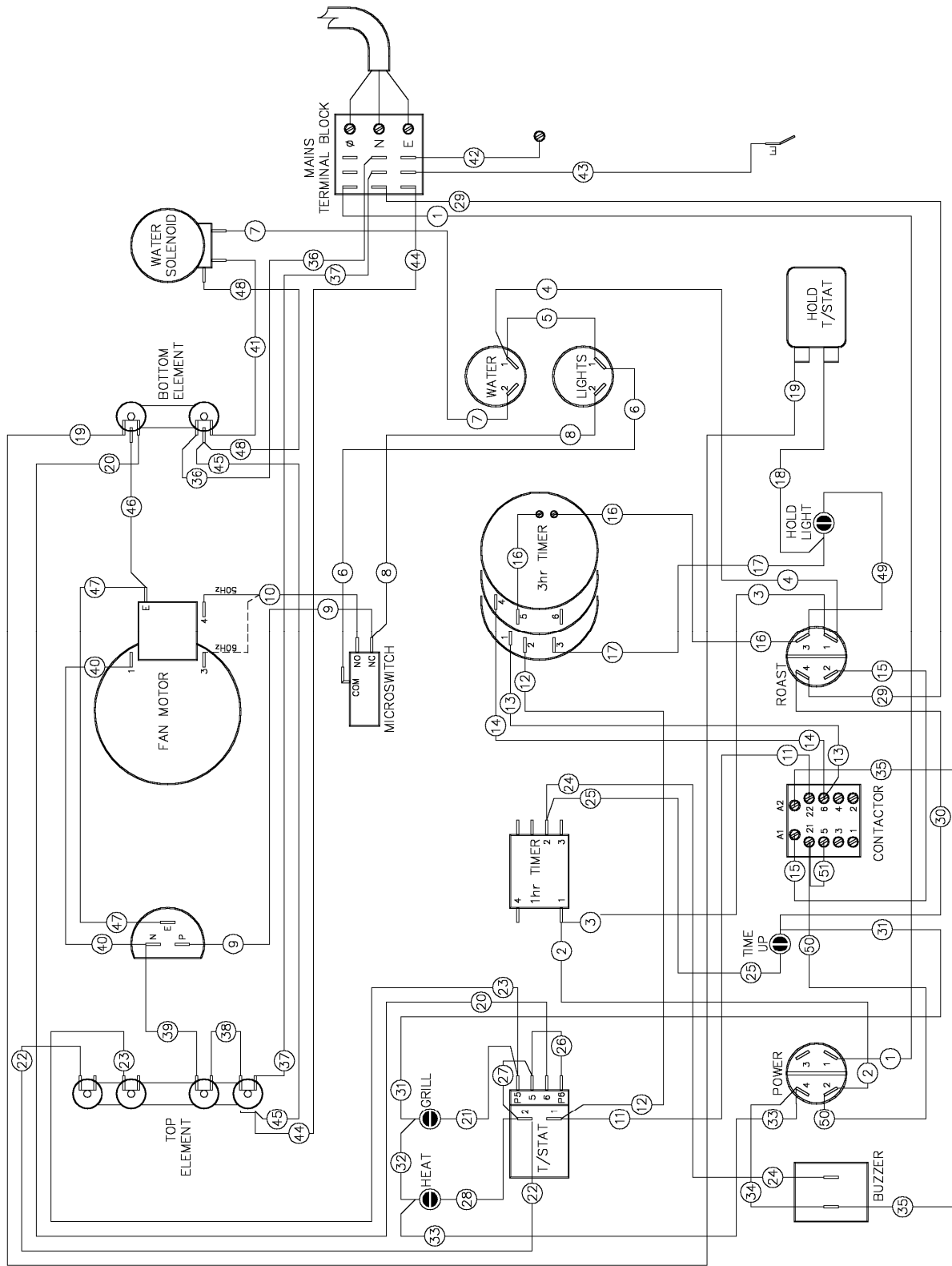

9. SPARE PARTS

PART NO	DESCRIPTION
----------------	--------------------

CONTROLS

M021473	Switch - Power
M017121	Thermostat
M020823	Knob - Thermostat / Bake Timer
M020849	Neon Indicator
M011760	Bake Timer
M011794	Buzzer
M021476	Switch - 'Roast n Hold'
M011419	'Roast n Hold' Timer
M021472	'Roast n Hold' Timer Knob
M021474	Switch - Steam / Light
M022281	Relay
M018223	Hold Thermostat
M002990	Microswitch
M003002	Oven Lamp Glass
M003434	Silk Gasket
M013521	Oven Lamp - 40W Min. Edison Screw

MOTOR & ELEMENTS

M003113	Oven Top Element 208 Volts
M003114	Oven Bottom Element 208 Volts
M011604	Oven Top Element 240 Volts
M003074	Oven Bottom Element 240 Volts
M013431K	Fan Motor
M013432	Oven Fan

STEAM SYSTEM

M012781	Water Solenoid
---------	----------------

DOOR

M014225	Oven Door Seal Strip Side
M014226	Oven Door Seal Strip Top / Bottom
M021469	Handle Assembly
M021468	Handle
M021465	Handle Bracket
M021444	Door Outer Glass
M002340	Door Inner Glass
M011005	Door Catch
M013610	Door Bush

RACKS

M003382	Oven Side Rack
M012809	Oven Rack

10. ACCESSORIES

OVEN RACKS (PART NO M012809)

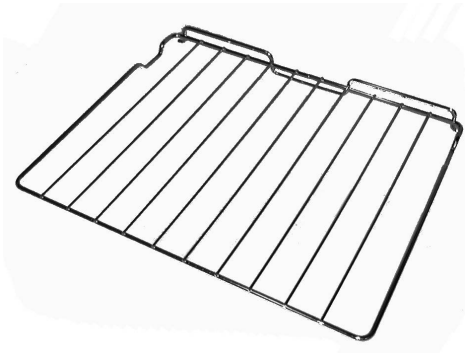

**100 MM (FOUR INCH) FOOT OPTION
(PART NO M013048)**



**25 MM (ONE INCH) FOOT OPTION
(PART NO M013908)**



A25 STAINLESS STEEL STAND



11. PARTS DIAGRAMS

11.1 MAIN ASSEMBLY

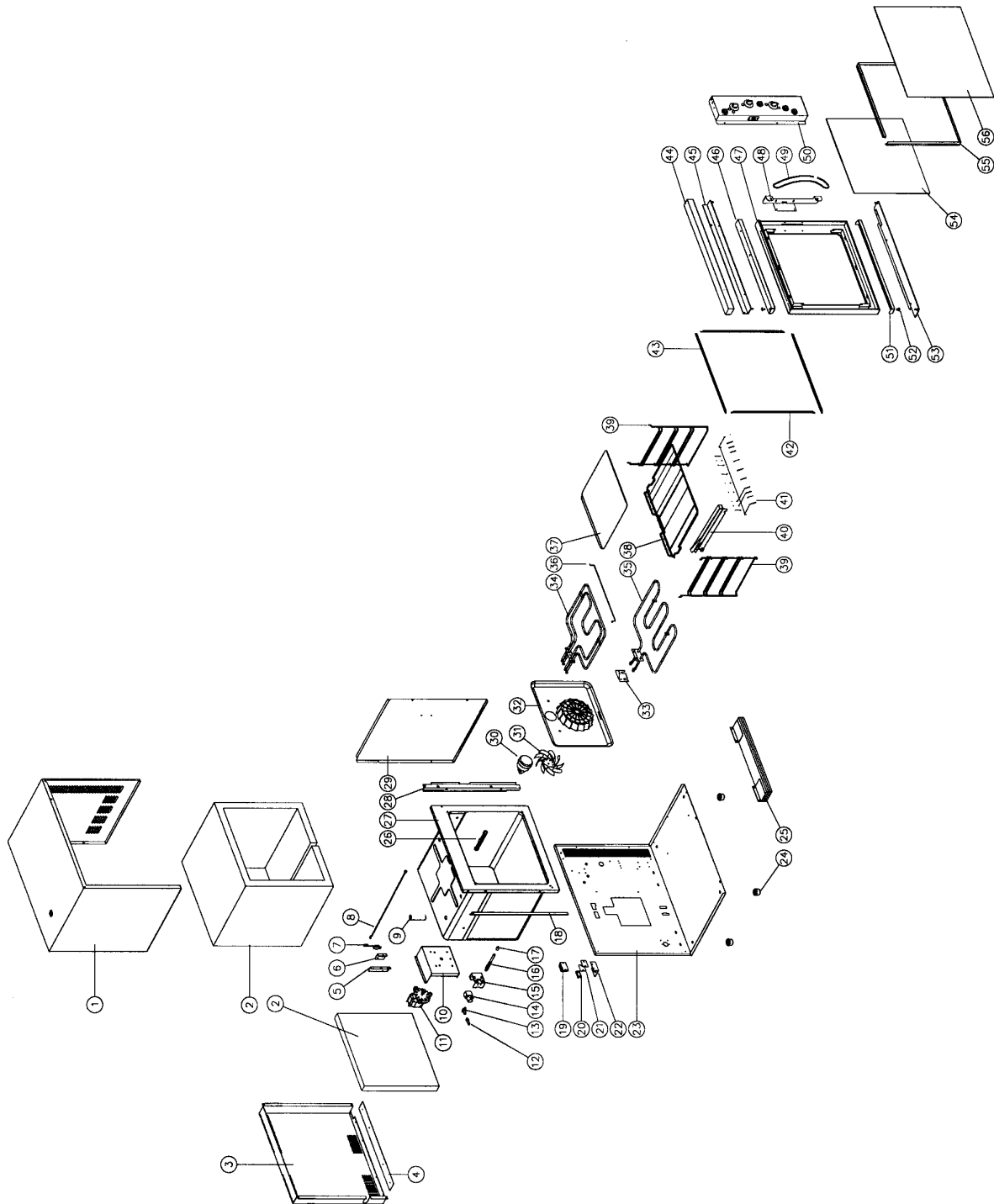

Pos	Part No.	Description
1	M021533	WRAPPER
2	M090406	INSULATION
3	M013011	COVER PANEL
4	M013012	COVER PANEL PLATE
5	M011412	MICROSWITCH BRACKET
6	M011389	MICROSWITCH INSULATOR
7	M002990	MICROSWITCH
8	M003012	ACTUATOR ROD
9	M011414	VENT TUBE
10	M003016	MOTOR MOUNTING PLATE
11	M013431K	MOTOR
12	M012782	HOSE CONNECTOR
13	M011634	ELBOW
14	M012781	SOLENOID VALVE
15	M019208	SOLENOID MOUNTING BRACKET
16	M012784	SOLENOID EXTENSION
17	M012785	INJECTOR
18	M011404	L.H OVEN SUPPORT
19	M013586	TERMINAL BLOCK
20	M002138	CABLE CLAMP
21	M002441	INSULATOR
22	M018251	CABLE ENTRY CLAMP BRACKET
23	M013053	BODY
24	M013048	LEG - 4" (100 mm)
	M013908	FOOT ASSEMBLY - 1" (25 mm)
25	M004594	COUNTERWEIGHT (UK ONLY)
26	M017770	PHIAL GUARD
27	M004004	OVEN INNER
28	M011413	R.H OVEN SUPPORT
29	M011407	SIDE INSULATION PANEL
30	M013520	OVEN LIGHT ASSEMBLY
	M003434	SILK GASKET
	M013521	LAMP 40W
	M003002	LIGHT GLASS
31	M013432	FAN
32	M004005	FAN BAFFLE (ALL MARKETS EXCEPT UK)
	M004595	FAN BAFFLE (UK ONLY)
33	M003123	BAFFLE BRACKET
34	M003113	TOP ELEMENT 208 - 220V
	M011604	TOP ELEMENT 230 - 240V
35	M003074	BOTTOM ELEMENT 230 - 240V
	M003114	BOTTOM ELEMENT 208 - 220V
36	M003219	ELEMENT SUPPORT
37	M002083	SCONE TRAY (UK ONLY)
38	M012809	OVEN RACK
39	M003382	OVEN SIDE RACK (ALL MARKETS EXCEPT USA/CANADA)
	M012798	OVEN SIDE RACK (USA/CANADA ONLY)
40	M012787	WATER TROUGH
41	M003057	BOTTOM ELEMENT GUARD
42	M014225	OVEN SEAL ASSEMBLY - VERTICAL
	M003028	VERTICAL SEAL - 455mm
43	M014226	OVEN SEAL ASSEMBLY - HORIZONTAL
	M003038	HORIZONTAL SEAL - 508mm
44	M004731	PIVOT COVER - TOP
45	M011422	PIVOT SUPPORT - TOP ASSEMBLY
46	M021528	TOP TRIM
47	M004006	DOOR INNER

48	M021465	HANDLE BRACKET (HANDLE ASSEMBLY 021469)
49	M021468	HANDLE (HANDLE ASSEMBLY 021469)
50	-----	CONTROL ASSEMBLY (SEE SECTION 1.2.1)
51	M021530	BOTTOM TRIM
52	M013610	DOOR BUSH (ALSO USED ON CONTROL PANEL PIVOT)
53	M011424	PIVOT SUPPORT - BOTTOM ASSEMBLY
54	M002340	DOOR INNER GLASS
	M090201	SILICON EXTRUSION - 1.74M
55	M004452	DOOR GLASS CLAMP ANGLE
56	M021444	DOOR OUTER GLASS
	M090225	SILICON EXTRUSION - 0.96M

11.2 CONTROL PANEL ASSEMBLY

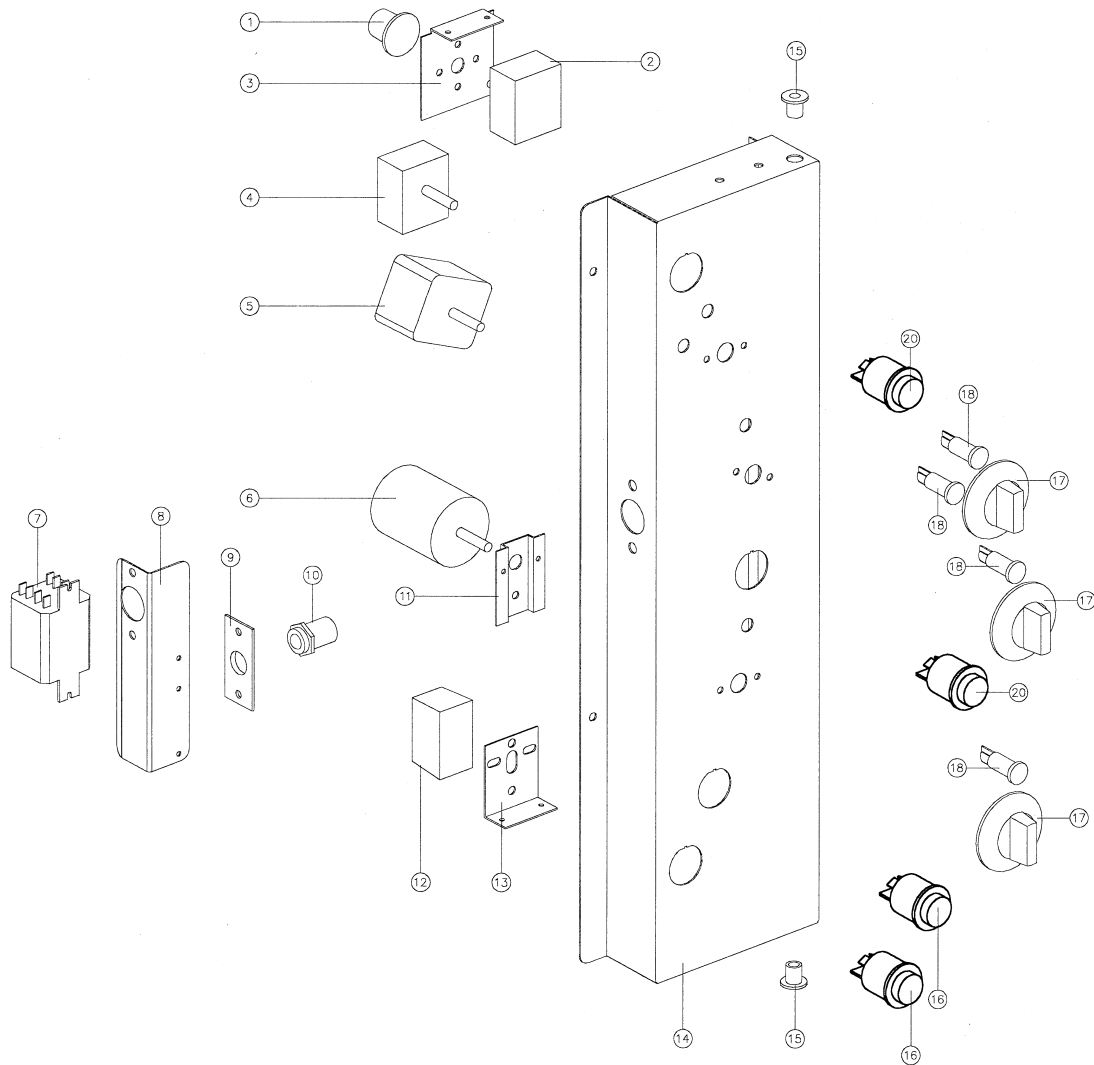

Pos	Part No.	Description
1	M018224	HOLD THERMOSTAT KNOB
2	M018223	HOLD THERMOSTAT
3	M021538	HOLD THERMOSTAT BRACKET (AFFIX 018209 LABEL)
4	M017121	THERMOSTAT 50-300 °C
5	M011760	TIMER - 1 Hr
6	M011419	TIMER - 3 Hr (240V 50 Hz)
	M011983	TIMER - 3 Hr (240V 60 Hz)
7	M022281	CONTACTOR
	M022282	CONTACTOR KIT (REPLACES 22199 & 21491 RELAYS) (PRE S/N 42473)
8	M021536	CONTACTOR BRACKET
9	M018789	BALL CATCH PLATE
10	M011005	BALL CATCH & LOCKNUT
11	M021442	TIMER MOUNTING PANEL
12	M011794	BUZZER
13	M021537	BUZZER MOUNTING BRACKET
14	M004722	CONTROL PANEL BAKBAR °C
	M004803	CONTROL PANEL BLUE SEAL °C
	M004729	CONTROL PANEL MOFFAT °F
15	M013610	DOOR BUSH
16	M021474	LIGHT / STEAM SWITCH
17	M020823	THERMOSTAT / TIMER KNOBS
18	M020849	PILOT LIGHT
19	M021476	ROAST 'N' HOLD SWITCH
20	M021473	POWER SWITCH

11. SERVICE CONTACTS

AUSTRALIA

VICTORIA HEAD OFFICE AND MAIN WAREHOUSE
740 Springvale Road
Mulgrave VIC 3170
Spare Parts Department

Tel (03) 9518 3888
Fax (03) 9518 3838
Free Call 1800 337 963
Fax (03) 9518 3895

NEW SOUTH WALES
Unit 8/142 James Ruse Drive
Rosehill NSW 2142
Spare Parts

Free Call 1800 337 963
Fax (03) 9518 3895

QUEENSLAND
30 Prosperity Place
Geebung QLD 4034
Spare Parts

Free Call 1800 337 963
Fax (03) 9518 3895

SOUTH AUSTRALIA
Suite 8/71 Fullarton Rd
Kent Town SA 5067
Spare Parts

Tel (08) 8431 0522
Free Call 1800 337 963

WESTERN AUSTRALIA
PO Box 689
Joondalup Business Centre WA 6027
Spare Parts

Tel (08) 9305 8855
Free Call 1800 337 963

**NATIONAL COVERAGE FOR 24 HOUR SERVICE OR MAINTENANCE DIAL
FREE CALL 1800 622 216 (AUSTRALIA ONLY)**

CANADA

Lessard Agencies Limited
PO Box 97
Stn "D"
Toronto, ONT M6P 3J5

Tel (416) 766 2764
Fax (416) 760 0394
Free Call 1 888 537 7273

NEW ZEALAND

CHRISTCHURCH
16 Osborne St
PO Box 10-001
Christchurch
Spare Parts

Free Call 0800 Moffat
(0800 663 328)

Tel (03) 389 1007
Fax (03) 389 1276

AUCKLAND
4 Waipuna Road
Mt Wellington
Auckland
Spare Parts

Tel (09) 574 3150
Fax (09) 574 3159

Free Call 0800 Moffat
(0800 663 328)

UNITED KINGDOM

BLUESEAL LTD
Units 6-7 Mount St
Business Park
Birmingham B7 5QU
England

Tel 0121-327 5575
Fax 0121-327 9711

UNITED STATES OF AMERICA

MOFFAT INC.
3765 Champion Blvd
Winston-Salem
NC27115

Tel 1-8666737937
Fax 336 661 9546

**NATIONAL COVERAGE FOR SERVICE OR MAINTENANCE DIAL
FREE CALL 1866 673 7937 (USA ONLY)**

APPENDIX A. POWER RELAY UPGRADE KIT

Kit Includes

1	x	Power relay
2	x	Screw - 8 x $\frac{3}{8}$ truss
1	x	160mm black wire
1	x	180mm red wire
1	x	950mm red wire
1	x	1050 red wire

Assembly Instructions: (THE ELECTRICAL SUPPLY MUST BE DISCONNECTED)

- 1) Remove the rear service panel.
- 2) Mark and drill 2x $\varnothing 3.5$ mm holes as per figure A.1.
- 3) Mount relay to holes with 2 screws provided.
(NOTE: Terminals on relay must face upwards).
- 4) Connect 160mm black wire to vacant neutral (L2) terminal on terminal block and to terminal B on relay.
- 5) Connect short (180mm) red wire to vacant phase (L1) terminal on terminal block and to terminal 7 on relay.
- 6) Connect long thick red wire (950mm) to power relay terminal 4 and remaining long thin wire (1050mm) to relay terminal A. Feed these wires through the plastic bush in the rear of the oven and into the control cavity.
- 7) Loosen screws and open the control panel.
- 8) **Units with mini-contactor:**
Remove and discard wire from terminal 2 on the power switch to terminal 21 on the mini contactor inside the control panel.
Locate end of thick red wire previously fed into control cavity and connect to terminal 21 of the contactor.
Units with 'Schrack' relay:
Remove and discard wire from terminal 2 on the power switch to terminal 7 on the 'Schrack' relay inside the control panel.
Locate end of thick red wire previously fed into control cavity and connect to terminal 7 of the 'Schrack' relay.
- 9) Locate long thin red wire and connect to terminal 2 on the power switch.
- 10) Close and fasten control panel taking care not to trap any wires.
- 11) Replace and fasten rear service panel.

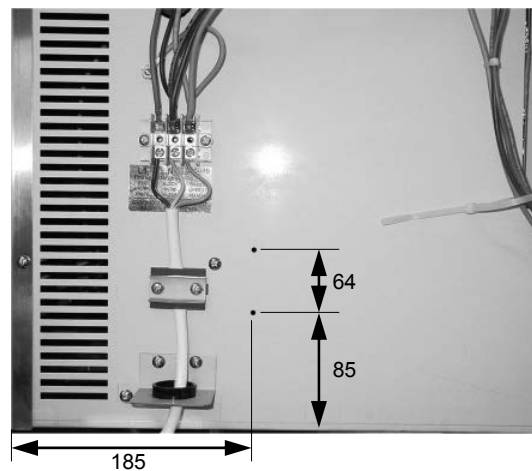

Figure A.1

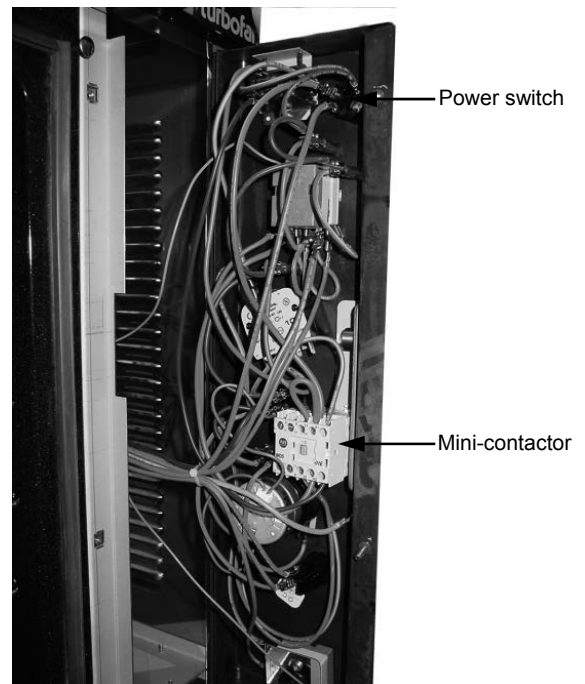
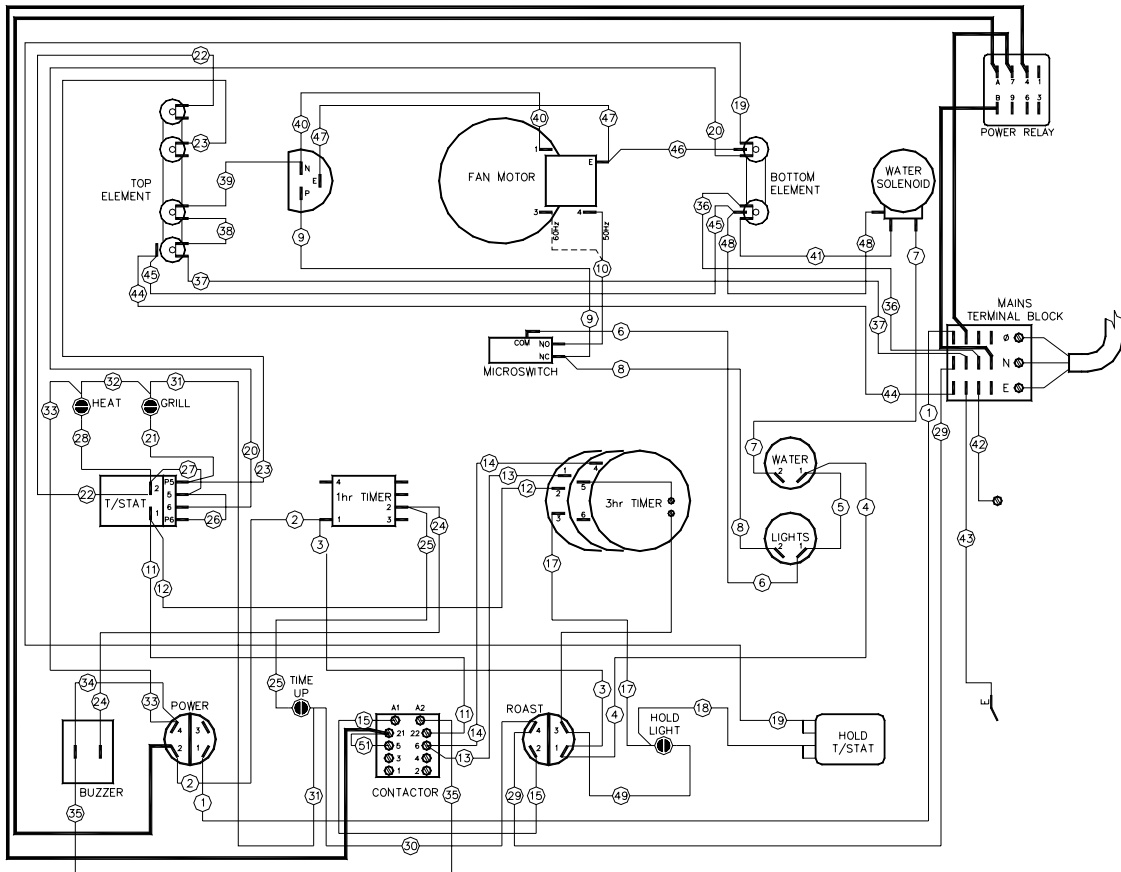

Figure A.2

Units fitted with mini-contactor:



Units fitted with 'Schrack' relay:

