

**turbofan<sup>®</sup>**

# **E33D5**

- 2 Speed Fan
- Moisture Mode
- Multi-Stage Cooking
- Optional Core Temp Probe

**Installation and Operation Manual**

**turbofan**  
CONVECTION OVEN SYSTEMS

**MOFFAT<sup>®</sup>**

**BLUE SEAL<sup>®</sup>**

---

## MANUFACTURED BY

### Moffat Limited

Christchurch  
New Zealand

## INTERNATIONAL CONTACTS

### AUSTRALIA

#### Moffat Pty Limited

**Web:** www.moffat.com.au  
**E.Mail:** vsales@moffat.com.au  
**Main Office:** (tel) +61 (03) 9518 3888  
(fax) +61 (03) 9518 3833  
**Service:** (tel): 1800 622 216  
**Spares:** (tel): 1800 337 963  
**Customer Service:** (tel): 1800 335 315  
(fax): 1800 350 281

### CANADA

#### Serve Canada

**Web:** www.servecanada.com  
**E.Mail:** info@servecanada.com  
**Sales:** (tel): 800 551 8795 (Toll Free)  
**Service:** (tel): 800 263 1455 (Toll Free)

### NEW ZEALAND

#### Moffat Limited

**Web:** www.moffat.co.nz  
**E.Mail:** sales@moffat.co.nz  
**Main Office:** (tel): 0800 663328

### UNITED KINGDOM

#### Blue Seal

**Web:** www.blue-seal.co.uk  
**E.Mail:** sales@blue-seal.co.uk  
**Sales:** (tel): +44 121 327 5575  
(fax): +44 121 327 9711  
**Spares:** (tel): +44 121 322 6640  
(fax): +44 121 327 9201  
**Service:** (tel): +44 121 322 6644  
(fax): +44 121 327 6257

### UNITED STATES

#### Moffat

**Web:** www.moffat.com  
**Sales:** (tel): 800 551 8795 (Toll Free)  
(tel): +1 336 661 1556  
(fax): +1 336 661 9546  
**Service:** (tel): 800 858 4477 (Toll Free)  
(tel): +1 336 661 1556  
(fax): +1 336 661 1660

### REST OF WORLD

#### Moffat Limited

**Web:** www.moffat.co.nz  
**E.Mail:** export@moffat.co.nz

---

The reproduction or copying of any part of this manual by any means whatsoever is strictly forbidden unless authorized previously in writing by the manufacturer.

In line with policy to continually develop and improve its products, Moffat Ltd. reserves the right to change the specifications and design without prior notice.

# Contents List

---

## E33D5 Turbofan Convection Oven.

<b>Introduction.....</b>	<b>2</b>
Safety Information	
<b>Specifications.....</b>	<b>3</b>
<b>Installation .....</b>	<b>4</b>
Installation Requirements	
Unpacking	
Location	
Clearances	
Stand Mounted Ovens	
Electrical Connection	
Water Connection	
Recommended Water Specifications	
Positioning and Levelling of Oven	
Initial Start-Up	
Commissioning	
<b>Operation .....</b>	<b>6</b>
Operation Guide	
Cooking in Manual Mode	
Cooking in Manual Mode using Core Temp Probe	
Cooking in Program Mode	
<b>Programming .....</b>	<b>13</b>
<b>Controller - Operator Settings.....</b>	<b>16</b>
Changing Operator Settings	
Operator Settings	
<b>Cleaning and Maintenance .....</b>	<b>17</b>
Cleaning Guidelines	
Oven Cleaning	
Periodic Maintenance	
<b>Fault Finding .....</b>	<b>20</b>
<b>Electrical Schematics.....</b>	<b>21</b>
<b>Replacement Parts List.....</b>	<b>22</b>

---

# Introduction

---

Before using your new oven, please read this instruction manual carefully, pay particular attention to any information labelled **'WARNING'**, **'CAUTION'**, **'IMPORTANT'** or **'NOTE'** in this manual.



Indicates a hazardous situation which, if not avoided, will result in death or serious injury.



Indicates a hazardous situation which, if not avoided, will result in minor or moderate injury.

If you are unsure of any aspect of the installation, instructions or performance of your oven, contact your TURBOFAN dealer promptly. In many cases a phone call could answer your question.

Should you contact your TURBOFAN dealer on any matter concerning this oven, please have the information provided opposite, readily available.

This manual must be kept by the owner for future reference.

A record of **Date of Purchase**, **Date of Installation** and **Serial Number of the oven** should be recorded in the area provided below.

*The serial number of this oven can be found on the Technical Data Plate located on the front right hand side panel, see diagram in 'Installation Section'.*

---

**Model Number:**

---

**Serial Number:**

---

**Dealer:**

---

**Service Provider:**

---

**Date Purchased:**

---

**Date Installed:**

## Safety Information

For your safety, please pay attention to the following symbols marked on the appliance.

### - Risk of electric shock.



- No user serviceable parts inside.
- Qualified service person access only.
- Disconnect from power before servicing.

# Specifications

## E33D5

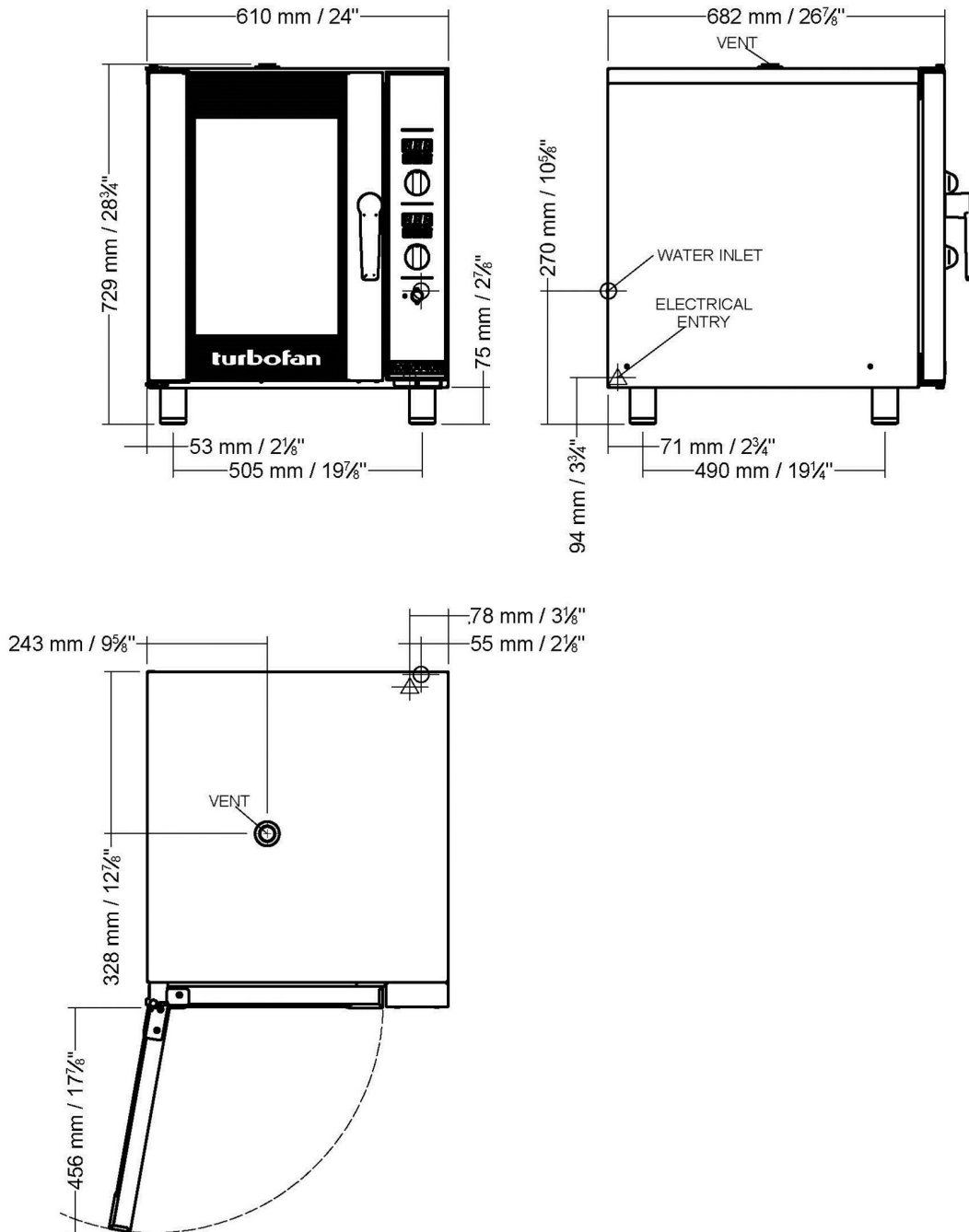

Oven Power Ratings		USA / Canada	Other Markets
		208V, 60Hz, 5.4kW. 220 - 240V, 60Hz, 6.0kW.	220V, 50Hz or 60Hz, 6.0kW. 230 - 240V, 50Hz or 60Hz, 6.0kW.
Oven Tray Details	Tray Capacity	5 Shelf - 13" x 18" Bun Pan. 12" x 20" Steam Pan.	5 Shelf, 1/1 GN Pan.
	Tray Spacing	3 1/3" / 85mm.	85mm / 3 1/3".
Water Connection	Max Water Pressure	80psi / 550kPa.	80psi / 550kPa.
	Connection Size	3/4" GHT.	3/4" BSP.

**NOTE:** If the Moisture Mode cooking option is not required, the oven does not need to be connected to a water supply.

# Installation

## Installation Requirements

### **Important:**

- Installation shall comply with local electrical, health and safety requirements.
- It is most important that this oven is installed correctly and that oven operation is correct before use.
- If you have any questions regarding the proper installation and / or operation of this oven, please contact your local Turbofan distributor.

### Unpacking

1. Remove all packaging and transit protection including all protective plastic coating from the exterior stainless steel panels.
2. Check the oven and supplied parts for damage. Report any damage immediately to the carrier and distributor.
3. Check that the following parts have been supplied with your oven:-
  - 4 x Leg Adjustable.
  - Adaptor Brass.
  - Washer Rubber. } USA / Canada only.
4. Report any deficiencies to the distributor who supplied your oven.
5. Securely fit the 4 legs supplied with the oven.
6. Check that the available electrical supply is correct to that shown on the Technical Data Plate located on the front right hand side panel.

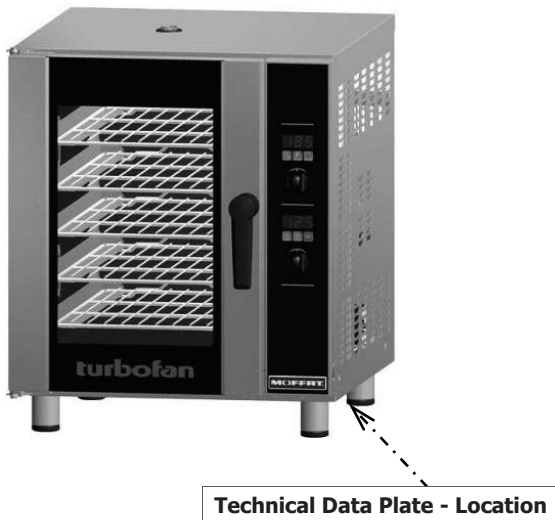

- Also refer to 'Specifications' section, 'Oven Specifications Table' on previous page.

### Location

1. Position the oven in its approximate working position.
2. The unit should be positioned so that the control panel and oven shelves are easily reachable for loading and unloading.

### Clearances

To ensure correct ventilation for the motor and controls, the following minimum installation clearances are to be adhered to:-

Top	200mm / 8".
Rear	50mm / 2".
Left-hand side	50mm / 2".
Right-hand side	75mm / 3".

### **Clearance From Source of Heat.**

**A minimum distance of 300mm (12") from the appliance sides is required.**

**NOTE: Fixed installations require at least 500mm (20") clearance for service access.**

### **Important:**

**The vent located on the top of the oven must NOT be obstructed.**

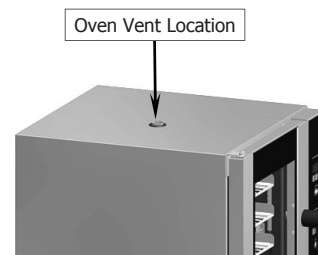

### Stand Mounted Oven

For stand mounted ovens, the oven feet are used to level the oven on the stand. Refer to the instructions supplied with separately ordered stands for mounting details.

# Installation

## Electrical Connection



### Warning

**This oven must be earthed / grounded.**

Each oven should be connected to an adequately protected power supply with an appropriate three wire power cord.

An isolation switch must be mounted adjacent to, but not behind the oven and must be readily accessible to the operator. This switch must be clearly marked and readily accessible in case of fire.

Check the electricity supply is correct to as shown on the Technical Data Plate on the front right hand corner of the oven side panel.

**NOTE: All electrical connections must only be carried out by a suitably qualified person.**

1. Remove oven right hand side panel.
2. Bring the supply cable up through the grommet at the back of oven and through the compression gland on the electrical switchgear panel.
3. Connect the mains supply to the appropriately marked terminals on the terminal block.

## Water Connection

**NOTE: If the Moisture Mode cooking option is not required, the oven does not need to be connected to a water supply.**

1. Tighten the 2 screws securing the water connection to the rear of the oven. (These have purposely been left loose to prevent damage to the water connection during transit).
2. Connect a cold water supply to the water inlet (R 3/4" Connector) on the oven.



**- Max Inlet Pressure 80psi / 550kPa.**

5. Turn 'On' the water supply and check for leaks.

## Recommended Water Specifications

In order to prevent corrosion or scaling in the oven and water system due to supplying water that is either too soft or too hard, the following recommendations should be used as a guideline.

**Hardness: Between 60 and 90ppm.**  
**PH: Greater than 7.5.**  
**Chlorides: Less than 30ppm.**

## Positioning and Levelling of Oven

1. Correctly locate the oven into its final operating position and using a spirit level, adjust the oven feet so that the oven is level and at the correct height.

## Initial Start-Up

Before using the new oven;

1. When using the oven for the first time, operate oven for about 1 hour at 200°C / 400°F to remove any fumes or odours which may be present.
2. Please refer to the Operation Section of this manual for details on how to correctly operate and shutdown the oven.

## Commissioning

Before leaving the new installation;

1. Check the oven functions in accordance with the operating instructions specified in the 'Operation' section of this manual.
2. Ensure that the operator has been instructed in the areas of correct operation and shutdown procedure for the appliance.

**NOTE: If it is not possible to get appliance to operate correctly, turn 'Off' power at the mains supply and contact supplier of this appliance.**

# Operation

## Operation Guide



### Warning

Some parts of this oven will become **VERY HOT** during use and could cause burns if touched.



### Warning

Take care when opening the oven door during baking. Let the hot air and steam escape before removing or replacing food as the steam produced can cause steam burns.

- This oven is intended for use in a commercial kitchen and must only be put to the use for which it was intended, i.e. cooking food product. To use this oven correctly please read the following sections carefully:-

185

### Temperature Display -

Shows pre-set chamber temperature. When used with the 'Temp' key, display shows actual oven temperature for 5 seconds. Shows cooking programs and error codes.



### 'Steam' Key and LED -

Used to set moisture level or to provide a manual injection of moisture when in Manual Moisture Mode. LED is 'On' when automatic moisture injection is set or when moisture is manually injected.

### Temperature Adjustment Control

125

### Time Display -

Shows cook time in full minutes only from 180 - 10, and in minutes and seconds for the final 10 minutes.

### NOTE:

In Core Temp Mode, time display alternates between 'CP' and set core probe temperature.



### 'On-Off/Light' Key and LED -

A dual-function key:  
Press 'On-Off/Light' key once to turn the oven 'On'  
When oven is turned 'On', press 'On-Off/Light' key to switch oven light 'On-Off'.  
Press and hold 'On-Off/Light' key for 1.5 seconds to turn the oven 'Off'.

### Time Adjustment Control

NOTE: In Core Temp Mode, 'Timer' knob is used to set core probe temperature.

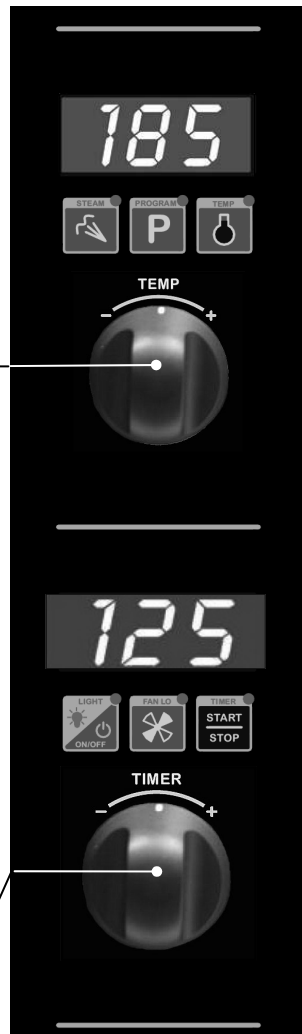

### 'Program' Key and LED -

Used to select cooking programs, and to set program parameters.



### 'Temp' Key and LED -

Displays actual oven temperature for 5 seconds on Temperature Display. LED 'On' when heating element is on (heating indicator).

LED flashes when Upper Display is showing actual temperature.

### NOTE:

In Core Temp Mode, this key is used to display Actual Oven Temperature (Upper Display) and actual Core Probe Temperature (Lower Display).



### 'Fan Lo' Speed Key and LED -

Switches oven fan from high to low speed. LED is 'On' when fan is in Low Speed Mode. When LED is 'Off', fan is in High Speed Mode.



### 'Timer-Start/Stop' Key & LED -

The 'Timer-Start/Stop' key is used to control the following functions:-

- Cancelling Alarm (All Modes).
- Starting Core Temp Mode (Core Temp Mode).
- Starting Timer (Manual Mode).
- Pausing (Manual / Program Modes).
- Re-Setting Timer (Manual Mode).
- Starting Program (Program Mode).
- Cancelling and Re-Setting Program (Program Mode).

Core Probe Connection Point.



# Operation

## Manual Mode

In Manual mode the ovens settings are.

- Temperature - 50-250C / 150-550F.
- Timer setting - 0-180min or Infinite.
- Fan Speed setting - Hi / Lo.
- Moisture Mode settings - Off / On-Level.
- Oven lights - Off / On.

An Optional Core Probe can also be used in Manual Mode.

## Program Mode

In Program Mode 20 Programs are able to be used.

In each program the following settings are possible.

- Temperature - 50-250C / 150-550F.
- Time - 0-180min or Infinite.
- Fan Speed - Hi/ Lo.
- Moisture Mode - Off / On-level.

3 cooking stages can also be set in each of the 20 programs.

- All settings can be changed between cooking stages.
- At completion of each stage an end of stage alarm can also be set.

Optional Core Probe can also be used in Program Mode.

## Changing between Manual to Program Modes



Press 'Program' key to select Program Mode. The LED will illuminate showing Program Mode now set. Press 'Program' Key to return to Manual mode.

## Fan Speed

This oven features a 2 speed fan.

- Hi Speed - This is the default operating speed.
  - Hi Fan should be used for most applications.
  - Hi Fan provides the fastest cooking time and evenness throughout oven.
- Lo Speed - This is the optional setting.
  - Lo Fan speed is selected using the Fan Lo key.
  - Lo Fan provides slower cooking with less fan affect on the product.
  - Lo Fan should be used on delicate products such as cake and muffin.

On start-up, the oven will always default to normal Hi speed fan.

In Manual Mode, fan speed can be changed at any time during use.

In Program Mode, fan speed can be pre-set and each cooking stage can have a different fan speed.

## Changing the Fan Speed



Press 'FAN LO' key to change to Lo Fan speed. LED will illuminate showing Lo Fan speed is now set. Press 'FAN LO' key to change back to Hi Speed fan.

## Moisture Mode

There are 6 levels of pre-set moisture injection.

Each level defines the number of moisture injection pulses per moisture cycle during oven operation.

- H-0** Manual Moisture Mode. Automatic Moisture Injection is 'Off'. Pressing 'Steam' key in this mode will inject 1 shot of steam into the oven, ie, no steam injection without user input.
- H-1** Level 1. - Minimum automatic moisture injection setting. One moisture pulse per moisture cycle.
- H-2** Level 2.
- H-3** Level 3.
- H-4** Level 4.
- H-5** Level 5. - Maximum automatic moisture injection setting. Five moisture pulses per moisture cycle.

## Selecting Moisture Mode



Press 'Steam' key to activate Moisture Mode. 'Steam' key LED will illuminate when Moisture Mode is 'On'. Moisture Mode will operate at the preset level during the cooking cycle.

- When Moisture Mode H-0 is selected, a shot of steam is available whenever the oven is running, by pressing the 'Steam' key.
- When Moisture Mode H-1 to H-5 are selected, these moisture modes will only operate when a program is running, Core Temp Probe Mode has been selected or when a timer is running in Manual Mode.
- When setting Moisture level, consider the Oven Set Temperature. If set BELOW 100°C (212°F), water may pool in oven as temperature will be too low to create steam.

## Changing Moisture Mode Level



Press and hold the 'Steam' Key until the 'H-X' level is displayed and flashing in the upper display. Rotate the 'Temp' Knob -/+ to select Moisture Mode level required. Press the 'Steam' key to confirm setting.

The 'Moisture' Mode level can be changed at anytime during operation by following the setting method as described above.

## Core Temp Cooking Mode - Optional

An Optional Core Temp Probe Kit #236060 is available for this oven.

This allows use of the Core Probe Cooking feature of this oven. When the core probe is fitted to the connection point on control panel side, the timer function and display becomes the core temp probe temperature setting and display. Cooking completion is then determined by the core temp probe reaching the set core probe temperature.

To enable Core Probe Cooking Mode plug in the Core Probe. The Timer Display will then change to 'CP' (Core Probe). The Timer Knob function will then be for Core Temp setting. To disable Core Probe Cooking Mode, unplug the Core Probe. The Timer Display and Knob will return to time function.

# Operation

## Cooking in Manual Mode

On oven start-up the controller defaults to the following settings:-

Oven Temperature is set to 150°C (302°F). Refer 'Controller - Operator Settings' section to change this start-up temperature.

Oven Timer is not set, display shows ' - - '.

Moisture Setting is setting to Manual Injection.

Fan Speed is set to Hi Speed.

### 1. SET OVEN TEMPERATURE.



Rotate 'Temp' knob to select temperature required.

- + to increase the temperature (Max. 260°C / 500°F).
- to decrease the temperature (Min. 60°C / 140°F).

The oven will commence heating to the displayed set temperature.

**NOTE:** The oven can be used without using the timer.

### 2. SET TIMER.



Rotate 'Timer' knob to select time required.

- + to increase the time (Max. 180 minutes).
- to decrease the time (Min. 1 minute).

**NOTE:** Timer can be set to 'Infinity' **Inf**. If timer is set to 'Infinity', timer will count elapsed time to a max of 999 minutes and elapsed time will be shown on the Lower Display.

### 3. SET MOISTURE MODE.



Press and hold 'Steam' key for 3 seconds.

Rotate 'Temp' knob to select desired moisture level (H-0 to H-5).  
Press 'Steam' key to confirm settings.

**NOTE:** Refer to 'Moisture Mode Settings' at start of this section for additional explanation of moisture level adjustments.

### 4. SET FAN SPEED.



Press 'Fan Lo' key, to change fan speed. 'Fan Lo' LED will illuminate when fan low speed is selected.

### 5. STARTING TIMER.



Press 'Timer-Start/Stop' key to start timer operation. LED will illuminate to indicate the timer is running.

Pressing 'Timer-Start/Stop' key or opening oven door when timer is operating will pause timer and turn 'Off' fan and heating. Timer LED will flash.

Press and hold 'Timer-Start/Stop' key for 3 seconds to cancel timer.

### 6. CANCELLING 'TIME UP' ALARM (COOKING TIME COMPLETED).

When the set Cooking Time is completed, alarm will sound and Lower Display flashes.



- Press 'Timer-Start/Stop' key to cancel alarm, oven will continue cooking at Oven Set Temperature. Display will revert to Set Temperature and Time.

- Alternatively, open oven door to cancel alarm and turn 'Off' fan and heating. Close oven door to resume cooking at Oven Set Temperature. Display will revert to Set Temperature and Time.

**NOTE:** Any of the above settings can be adjusted during the cooking operation by using the above controls and keys.



- **Viewing Actual Oven Temperature.** Press 'Temp' key during cooking, Oven Actual Temperature will display on Upper Display for 5 seconds and then will revert to displaying Oven Set Temperature.

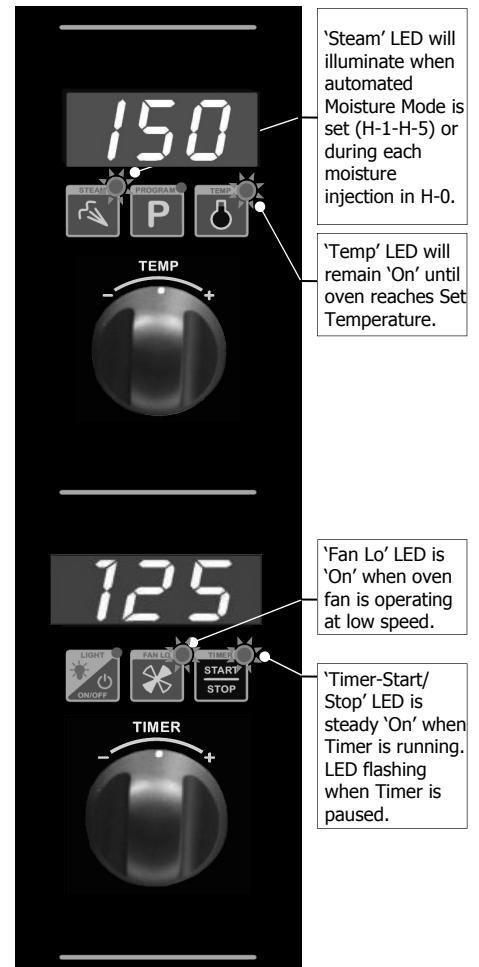

# Operation

## Cooking in Manual Mode using Core Temp Probe (Requires Optional Core Temp Probe Kit #236060).

On oven start-up the controller defaults to the following settings:-

Oven Temperature is set to 150°C (302°F). Refer 'Controller - Operator Settings' section to change this start-up temperature.

Oven Timer is not set, display shows ' - - '.

Moisture Setting is setting to Manual Injection.

Fan Speed is set to Hi Speed.

### 1. CONNECT CORE TEMP PROBE.

Connect Core Temp Probe to connector on lower right side of control panel,  will be displayed on Lower Display.

### 2. SET OVEN TEMPERATURE.



Rotate 'Temp' knob to select temperature required.  
**+ to increase the temperature (Max. 260°C / 500°F).**  
**- to decrease the temperature (Min. 60°C / 140°F).**

The oven will commence heating to the displayed set temperature.

### 3. SET CORE PROBE TEMPERATURE.



Rotate Timer Knob to set the desired core probe temperature.  
**+ to increase temperature (Max. 90°C / 194°F).**  
**- to decrease temperature (Min. 50°C / 122°F).**

Once Core Probe Set Temperature is set, Lower Display will alternately flash between  and Core Probe Set Temperature.

'Timer-Start/Stop' LED is 'Off', indicating that cooking has not yet started.

### 4. SET MOISTURE MODE.



Press and hold 'Steam' key for 3 seconds.  
Rotate 'Temp' knob to select desired moisture level (H-0 to H-5).  
Press 'Steam' key to confirm settings.

**NOTE:** Refer to 'Moisture Mode Settings' at start of this section for additional explanation of moisture level adjustments.

### 5. SET FAN SPEED.



Press 'Fan Lo' key, to change fan speed. 'Fan Lo' LED will illuminate when fan low speed is selected.

### 6. START CORE TEMP MODE COOKING.



Press 'Timer-Start/Stop' key to start Core Temp Mode cooking. 'Timer-Start/Stop' LED is 'On' during Core Temp Mode cooking. Lower Display will alternately flash between  and Core Probe Set Temperature during cooking.

### 7. CANCELLING CORE TEMP ALARM (CORE TEMP SETTING REACHED - COOKING COMPLETE).

When Core Probe Set Temperature is reached, an alarm will sound and the Lower Display will flash.



- Press 'Timer-Start/Stop' key to cancel alarm, oven will continue cooking at Oven Set Temperature. Display will show Oven Set Temperature and Core Probe Set Temperature.

- Alternatively, open oven door to cancel alarm and turn 'Off' fan and heating. Close oven door to resume cooking at Oven Set Temperature. The display will revert to the Oven and Core Probe Set Temperatures.

**NOTE:** Any of the above settings can be adjusted during cooking operation by using the above controls and keys.



- **Viewing Actual Oven and Core Temperatures.** During cooking, press 'Temp' key to check Oven Actual Temperature (Upper Display) and Core Probe Actual Temperature (Lower Display). Actual temperatures will display for 5 seconds before display reverts to show Oven Set Temperature (Upper Display) and Core Probe Set Temp (Lower Display).

- **Exiting Core Temp Cooking Mode.** Disconnect Core Probe from connector on lower right side of control panel. Lower Display and 'Timer' knob will revert to normal Timer Mode operation.

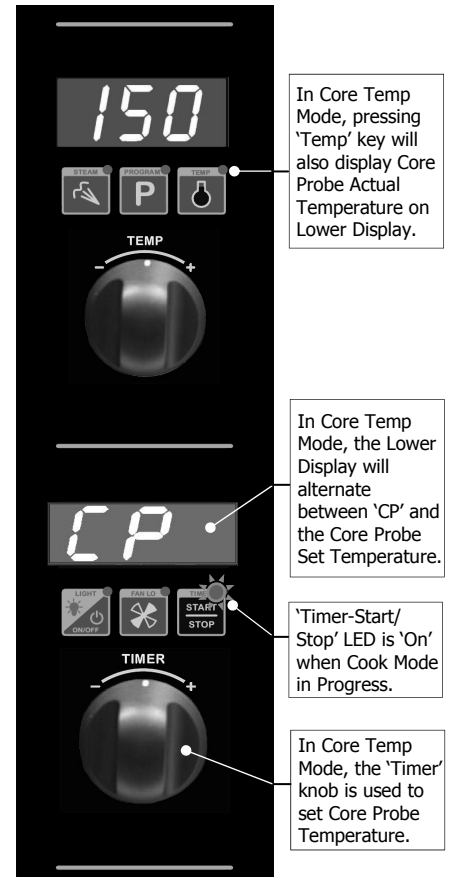

# Operation

## Cooking in Program Mode

The oven can be pre-programmed with up to 20 Programs; each program can contain a maximum of 3 stages. When you receive your oven, the controller is not pre-programmed.

### 1. SELECTING A PROGRAM.



Press 'Program' key.

Upper Display will show program number selected.



**+ to scroll forward through programs.**  
**- to scroll backward through programs.**

Lower Display will show **P-H**, oven is 'Pre-Heating'.  
Program cannot be started until pre-heating is completed.

### 2. OVEN READY.

Lower Display will show **rdy** when oven is up to pre-heat temperature and an alarm will sound.

Load product into oven.

### 3. CONNECT CORE TEMP PROBE (IF REQUIRED).

Connect Core Temp Probe to connector on lower right side of control panel,  
**CP** will be displayed on Lower Display.

**NOTE:** A Core Temp Probe can be used as part of a multi-stage cooking program. If a program reaches a Stage that requires a Core Temp Probe and no Core Temp Probe is connected, an error alarm will sound and 'CP' will flash on Lower Display. The program is automatically paused until the Core Temp Probe is connected. Once the probe is connected to the control panel and inserted into the food product, press the 'Timer-Start/Stop' key to resume the program.

### 4. START PROGRAM.



Press 'Timer-Start/Stop' key to start cooking program.

- Pressing 'Timer-Start/Stop' key when timer is operating, will pause timer and turn 'Off' Fan and Heating. LED will flash when timer is paused.
- Pressing and holding 'Timer-Start/Stop' key for 3 seconds will cancel the program and return to the Preset Program.

During Program Operation the Upper and Lower Displays will show the following:-

- Upper Display shows Program Number, e.g. **P01**
- Lower Display will show either,
  - Total Time Remaining in Program.OR
  - Total Elapsed Time of Program (if any Program Stages are set to CP or InF).OR
  - Alternate between 'CP' and Core Probe Set Temp (if presently in a Core Probe Stage).

### 5. CANCELLING PROGRAM 'TIME UP' ALARM (COOKING TIME COMPLETED).

When program is completed, the alarm will sound.



- To cancel alarm, press 'Timer-Start/Stop', oven will continue to cook at Oven Set Temperature. Display will revert to Program Number (Upper Display) and Total Program Time (Lower Display).
- Alternatively, open oven door to cancel alarm and turn 'Off' fan and heating. Close oven door to resume cooking at Oven Set Temperature. Display will revert to Program Number (Upper Display) and Total Program Time remaining (Lower Display).



'Program' LED is 'On' when Oven operating in Programs Mode.

# Operation

## ADDITIONAL ADJUSTMENTS (These can be adjusted whilst Program Mode is Running).

**NOTE:** Adjustments made during cooking will not be saved to the program.

### A. VIEWING STAGE NUMBER AND STAGE TIME REMAINING.

To view the Program and Stage numbers on the Upper Display, e.g. 3.1 = Program 3, Stage 1, and the Total Time Remaining in Stage remaining on the Lower Display:

- Press 'P' key during Program Cooking.

OR

- Turn Timer knob in either direction.

- Upper Display will show Program and Stage, e.g. **3.1**

- Lower Display will show either,
  - Total Time Remaining in Stage.

OR

- Total Elapsed Time of Stage (if Stage is set to 'InF').

OR

- Core Probe Set Temp (if Stage is set to 'CP').

OR

- Alternate between 'CP' and Core Probe Set Temp (if presently in a Core Probe Stage).

Display will revert back to Overall Display after 5 seconds.

### B. USING 'TEMP' KNOB DURING PROGRAM COOKING.

#### • VIEWING SET TEMPERATURE



Turn 'Temp' knob (in either direction) to display Set Temperature of Current Stage on Upper Display. Display will revert back to Overall Display after a 5-second delay.

#### • ADJUSTING SET TEMPERATURE



Hold 'Temp' knob in either direction for 3 seconds will enter 'Temp Edit Mode' where 'Temp' knob can be used to temporarily adjust temperature for the current stage. Controller will update the Temperature and exit 'Temp Edit Mode' after a 5-second delay.

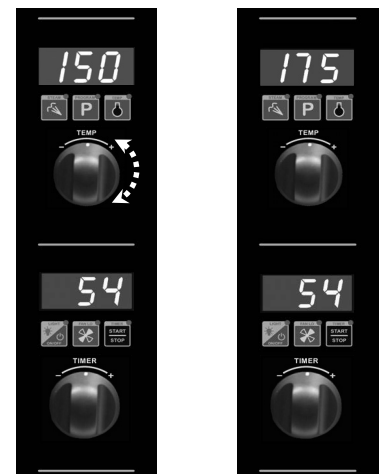

Here the Oven Set Temperature has been increased from 150 to 175°C (325 to 350°F).

### C. USING 'TIMER' KNOB DURING PROGRAM COOKING.

#### • VIEWING STAGE NUMBER AND REMAINING TIME



Turn 'Timer' knob (in either direction) to switch the display from Overall (Program, Total Time remaining) to Current Stage-in-Progress (Stage, Stage Time Remaining). Display will revert to Overall display after a 5-second delay.

#### • ADJUSTING REMAINING TIME / ADJUSTING CORE PROBE SET TEMP



Hold the 'Timer' knob in either direction for 3 seconds to enter 'Timer Edit Mode' where 'Timer' knob can be used for temporary adjustment of either:

- Core Probe Set Temperature.

OR

- Stage Time remaining.

The controller will update the value and exit 'Timer Edit Mode' after a 5-second delay. Time remaining can be adjusted between 0-180 minutes, but cannot be set to 'InF' or 'CP'.

Core Probe Set Temp can be set between 50-90°C (122-194°F).



Here Core Probe Temperature has been increased from 54 to 75°C (129 - 167°F).

**NOTE:** Any changes will only apply to the current stage. Any following stages will revert to the programmed settings.

# Operation

---

## D. CHANGING THE MOISTURE SETTING.



Press and hold 'Steam' key for 3 seconds.  
Rotate 'Temp' knob to select desired moisture level (H-0 to H-5).  
Press 'Steam' key to confirm settings.

**NOTE:** Refer to 'Moisture Mode Settings' at start of this section for additional explanation of moisture level adjustments.

## E. CHANGING FAN SPEED.



The pre-set fan speed can be changed by pressing 'Fan Lo' key. 'Fan Lo' indicator will illuminate when fan low speed is selected.

## F. VIEWING ACTUAL OVEN TEMPERATURE / ACTUAL CORE PROBE TEMPERATURE.



Press 'Temp' key during cooking. Oven Set Temperature will display on Upper Display for 2 seconds, then Actual Temperature will display on Upper Display for 2 seconds. At the same time, Actual Core Probe temperature will display on Lower Display for 4 seconds. After 4 seconds, controller will revert to displaying the program number.

## G. ADDING MORE TIME TO A STAGE WHEN THE END OF STAGE ALARM IS SOUNDING.

At the end of a stage, provided that 'ALr'=On, an end of stage alarm will sound for 1 minute before automatically progressing on to the next stage of the program. While alarm is sounding, additional cooking time can be added to the stage that has just finished.



Rotate and hold 'Timer' knob for 3 seconds to enter Timer Edit Mode and add time to the stage.  
When the length of time required has been added, either;



- Press 'Timer-Start/Stop' key to resume the stage,

**OR**

- Wait for the auto-resume feature to progress the oven on to the next stage, 1 minute after alarm initially sounded.



When the additional time has run out, the end of stage alarm will sound for a second time. Either press 'Timer-Start/Stop' key to progress on to the next stage, or let the program automatically progress on to the next stage after 1 minute of inactivity.

## H. TURNING THE LIGHTS 'ON/OFF'.



Whenever the oven is 'On', the 'On/Off-Light' key is used to turn the oven lights 'On/Off'. Press 'On-Off/Light' key to switch oven light 'On-Off'.  
To extend bulb life, an auto time-out can be pre-set to switch oven lights 'Off' after a set length of time. The factory default for time-out is 'Off' ('0', ie lights remain 'On' until light key is pressed again). This time-out can be activated by setting the 'Controller - Operator Settings', L-0 from 1-60 minutes.

**NOTE:** Any changes will only apply to the current stage. Following stages will revert to the programmed settings.

# Programming

## Programming

The oven can be pre-programmed with up to 20 Programs; each program can contain a maximum of 3 stages. When you receive your oven, the controller is not pre-programmed. To set programs, carry out the following for each program required:

### 1. SELECT PROGRAMS MODE.



Press 'Program' key to enter Programs Mode. 'Program' LED will illuminate.

### 2. SELECT PROGRAM REQUIRED (P01 - P20).

Rotate 'Temp' knob to the program required. Upper Display will show program selected.

### 3. ENTER PROGRAMMING MODE.



Press and hold 'Program' key until a beep is heard, indicating entry into Programming Mode. Upper Display shows program and stage numbers eg. = Program 3, Stage 1. **3.1**

'Program' LED will flash whilst in Programming Mode.

### 4. SELECT STAGE TO PROGRAM.

**NOTE:** If Multi-Stage Cooking is disabled, (Parameter 'StG' - refer to section 'Controller Operator Settings') skip to Step 6 to continue programming otherwise continue as below and overleaf.

All active stages and the first inactive stage are visible and can be accessed by rotating the 'Temp' knob to scroll through the stages. When editing a program for the first time, only the first stage will be visible and it will be 'Off' by default. Setting parameters for a stage changes its state from 'Off' to 'On' (activates the stage).

- To Turn a Stage 'On'.

**Either** - Rotate 'Timer' knob clockwise to select 'On'.

**Or** - Press 'P' key and program stage settings.

(Setting parameters for a stage automatically changes its state to 'On').

- To Turn a Stage 'Off'.

Rotate 'Timer' knob anti-clockwise to select 'Off'.

**NOTE:** Only the last active ('On') stage can be turned 'Off'.

Rotate 'Temp' knob:-

**'+' to advance one stage.**

**'-' to go to the previous stage.**

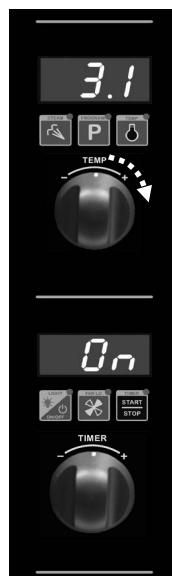
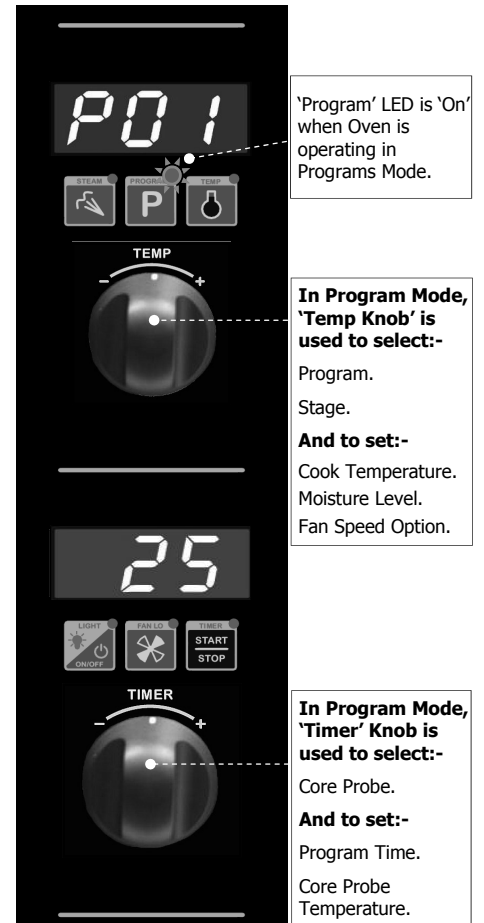

Program 3, Stage 1.  
STATE: ON.

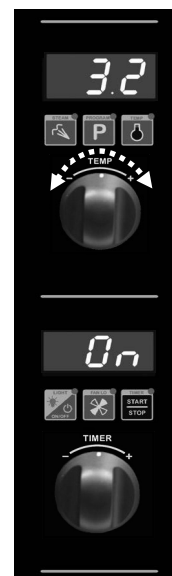

Program 3, Stage 2.  
STATE: ON.

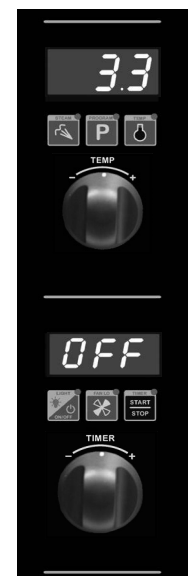

Program 3, Stage 3.  
STATE: OFF (ie; Inactive).

# Programming

## 5. CONFIRM STAGE TO EDIT.



Press 'Program' key to begin editing a program and stage displayed on the Upper Display.

## 6. SET OVEN TEMPERATURE.

\*Upper Display flashing\*

Rotate 'Temp' knob to select temperature required.

- + to increase the temperature (Max. 260°C / 500°F).
- to decrease the temperature (Min. 60°C / 140°F).

Press 'P' key to confirm temperature setting. Controller will step to Cook Time / Core Temp Probe setting.

## 7. SET COOK TIME / CORE TEMP PROBE.

\*Lower Display flashing\*

The 'Timer' knob can be used to select Core Temp Probe or a Cook Time option.



*Turn and Release Timer Knob to change selection.*

*Hold Knob to Fast Forward Fast Reverse.*

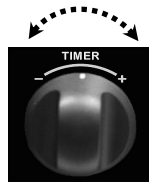

- = Stage has been set to 'OFF'.
- InF = Infinity Time Setting.
- CP = Core Temp Probe (optional extra).
- Time = From 1 minute to 180 minutes.

- **By setting a Cook Time**, the stage will be governed by Oven Temperature, Timer, Moisture setting and Fan Speed.

Rotate 'Timer' knob to select time required.

- + to increase Cook Time (Max. 180 minutes).
- to decrease Cook Time (Min. 1 minute).

Press 'P' key to confirm Timer setting and advance to setting Moisture setting.

- **By setting Core Temp Probe (CP)**, the stage will run at a set Oven Temperature, Moisture Mode and Fan Speed until the actual core temperature reaches the pre-set core probe temperature value. Refer to the 'Cooking in Manual Mode with Core Probe' Section for instructions on cooking with the Core Probe fitted. Turn and hold timer knob until lower display shows 'CP'. Controller will step to setting Core Probe Temperature. Core Probe Temperature value is displayed on Lower Display.

Rotate 'Timer' knob to select temperature required.

- '+' to increase Core Probe Temperature (Max 90°C / 194°F).
- '-' to decrease Core Probe Temperature. (Min 50°C / 122°F).

Press 'P' key to confirm Core Probe Temp Setting. Controller will step to Moisture setting.

- **By setting Infinite Time setting ('InF')**, Oven counts time upwards up to a limit of 999 minutes. The Infinite ('InF') timer option is only available as an option when setting the last stage of a program. If the 'InF' timer option is programmed, no stages after the 'InF' stage will be available / visible. Turn 'Off' all stages that come after a given stage in order to set an 'InF' timer for that stage.

Press 'P' key to confirm infinite time 'InF' setting and advance to setting Moisture setting.



# Programming

---

## 8. SET MOISTURE OPTION (H-0 - H-5).

\*Upper Display flashing\*

Rotate 'Temp' knob to select Moisture setting required.

'+' to increase moisture setting.

'-' to decrease moisture setting.

(Refer to Operation section, 'Moisture Mode Settings', for additional explanation of moisture level adjustment).

Press 'P' key to confirm Moisture setting. Controller will step to Fan Speed setting.

## 9. SET FAN SPEED (LO - HI).

Upper Display shows **FAN**

\*Lower Display Flashing with current Fan setting\*

Rotate 'Timer' knob to select desired fan option, shown on Lower Display.

Press 'P' key to confirm fan speed setting. Controller will step to Alarm setting for End of Stage.

**NOTE:** If Multi-Stage Cooking is disabled, (Operator setting 'StG' - set to 'no'), the controller will exit the Programming Mode after the 'P' key is pressed to confirm fan speed setting.

## 10. SET ALARM FOR END OF STAGE ('ON-OFF').

Upper Display shows **ALr**

\*Lower Display flashing with current alarm setting\*

Rotate 'Timer' knob to select desired alarm state which will be shown on the Lower Display.

**'ON'** - Alarm sounds at completion of the cooking stage, the program is paused awaiting user action. Without any input, the program will automatically resume after 1 minute.

- Press 'Timer-Start/Stop' key to stop the alarm, resume cooking and to continue to the next cooking stage.

**OR**

- Open oven door to stop alarm. Close door and press 'Timer-Start/Stop' key to continue cooking and to continue on to the next cooking stage.

**'OFF'** - Oven continues on to the next cooking stage without sounding an alarm.

**NOTE:** Regardless of the setting applied to the last stage of the program, a Cook Time Completed Alarm will sound to indicate the end of the program.

Press 'P' key to confirm alarm option. Alarm will sound to confirm that all stage parameters have been set.

**Repeat Step 1 to Step 10 to program additional stages.**

## 11. EXIT PROGRAMMING MODE.

Press and hold 'P' key for 3 seconds until alarm sounds to exit the Programming Mode.

# Controller - Operator Settings

## Changing Operator Settings

With the Oven in 'Stand-By' Mode (i.e. Power to oven but both displays are blank).

### 1. ENTERING THE OPERATOR SETTING MODE.



Press and hold 'Steam' and 'Timer-Start/Stop' keys together for 3 seconds.

Upper Display will show **PAS**.

Lower Display will flash **000**.

### 2. SETTING PASSWORD (OPERATOR PASSWORD - 123).



Rotate 'Timer' knob to set password **123**.

Press 'Fan Lo' key to confirm password.

Upper Display will show one of the setting codes, eg. **P-H**

Lower Display will show the value of the setting, eg. **185**

### 3. CHANGING THE OPERATOR SETTINGS.

Rotate 'Timer' knob to the setting required.



Press 'Fan Lo' key to confirm setting required. Lower Display will flash.

While Lower Display is flashing, rotate 'Timer' knob to select value required.



Press 'Fan Lo' key to confirm value. Lower Display will stop flashing.

### 4. EXITING THE OPERATOR SETTING MODE.



Press 'On-Off/Light' key, to return to Stand-By Mode.



## Operator Settings

Setting Number	Description	Setting Range	Default Setting
<b>P-H</b>	<b>Oven Pre-Heat;</b> - (Automatic Pre-Heat Temp on oven start-up).	<b>60 - 260°C</b> <b>140 - 500°F.</b>	<b>150°C</b> <b>(302°F)</b>
<b>L-0</b>	<b>Light Auto 'Off' Setting Time -</b> 0 = 'On/Off'. 1 = 1 minute auto 'Off'. 2 = 2 minutes auto 'Off', etc.	<b>0 - 60 mins.</b>	<b>0</b>
<b>uol</b>	<b>Alarm Volume -</b> Can be adjusted to suit operators preference.	<b>0 - 10.</b>	<b>5</b>
<b>P-rE</b>	<b>Program Pre-Heating Condition -</b> This setting allows for pre-heating 'Ready' temperature in 'Program Mode' Mode to be set higher than Program Set Temperature. Factory Default Setting is '0' (Equal to Program Setting).	<b>0 - 30°C</b> <b>0 - 54°F.</b>	<b>0</b>
<b>StG</b>	<b>Multi-Stage Enable -</b> This setting enables multi-stage programming. Factory default is 'YES', multi-stage programming is enabled. Setting this to 'no' simplifies programming and program cooking.	<b>'YES' or 'no'.</b>	<b>YES</b>

# Cleaning and Maintenance

## Cleaning Guidelines



### Caution

Always turn off electrical power at the mains supply before commencing cleaning.

This oven is not water proof. Do not use water jet spray to clean interior or exterior of the appliance.

To achieve the best results, cleaning must be regular and thorough. If any small faults occur, have them looked at promptly. Don't wait until they cause a complete breakdown.

### NOTE:

- Carefully read and follow the safety instructions on the label of the cleaning product to be used.
- DO NOT use harsh abrasive scouring pads or abrasive detergents as they could damage the oven.
- Ensure that any detergent or cleaning material has been completely removed after each cleaning.

To keep your oven clean and operating at peak efficiency, follow the procedures shown below:-

## Oven Cleaning

### NOTE:

- If oven usage is very high, the cleaning procedure should be carried out more frequently.
- Allow the oven interior to cool to approx 50°C / 120°F before commencing cleaning.

### Stainless Steel Surfaces

- a. Thoroughly clean the exterior surfaces of the oven with, a damp cloth moistened with a mild detergent solution, or a soft bristled brush.
- b. Baked on deposits or discoloration may require a good quality stainless steel cleaner. Always apply cleaner when the oven is cold and rub in the direction of the grain.

### Side Racks Removal

#### Right Rack / Fan Baffle

- a. Undo and remove the rack securing screw securing the front of the RH side rack. The fan baffle is an integral part of the RH Side Rack.
- b. Lift up and unhook the rear of the rack from the locating peg at the rear of the oven.

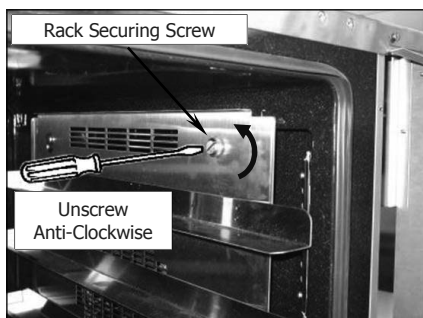

- c. Tilt the top of the rack inwards and lift the rack off the lower mounting brackets.

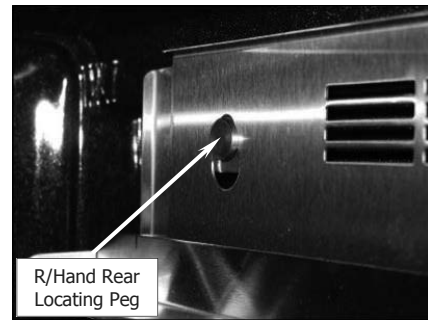

#### Left Rack

- a. Lift the LH rack off the front locating peg.

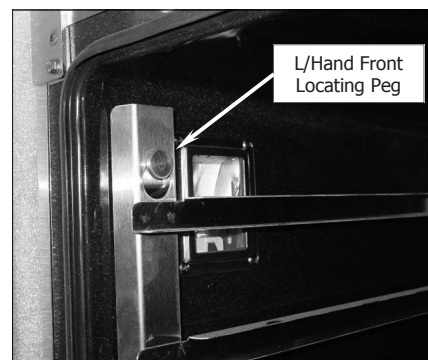

- b. Pull the rack forward out of the oven to disengage the rear of the rack from the rear location peg and remove the rack from the oven.
- c. Clean the racks with a mild anti bacterial detergent and hot water, using a soft bristled brush.



- d. Dry the racks thoroughly with a dry cloth.

# Cleaning and Maintenance

## Side Racks Re-Fitting

### Right Rack

- a. Align the bottom of the rack with the 2 brackets in the bottom RH side of the oven.

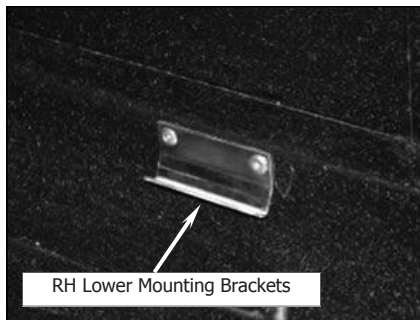

- b. Tilt the rack upwards and hook the top rear of the rack on to the locating peg in the top rear of the oven.

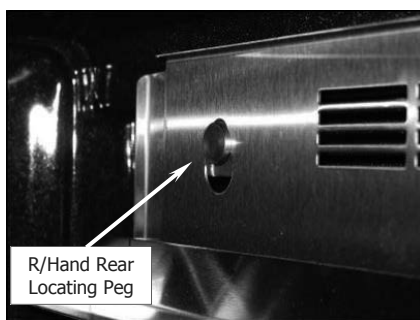

- c. Fit and tighten the rack securing screw to secure the front of the RH rack.

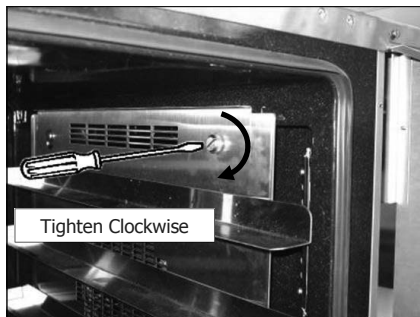

### Left Rack

- a. Locate the top rear of the rack onto the locating peg at the top rear LH side of the oven.

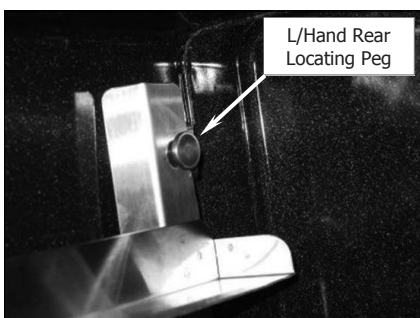

- b. Locate the top front of the rack over the locating peg at the top front LH side of the oven.

## Oven Lamp

- a. Remove the LH side rack as shown previously.



- b. Wash the glass lens with a soft sponge using warm water and a detergent solution. Rinse with clean, warm water.
- c. Dry the glass lens thoroughly with a dry cloth.

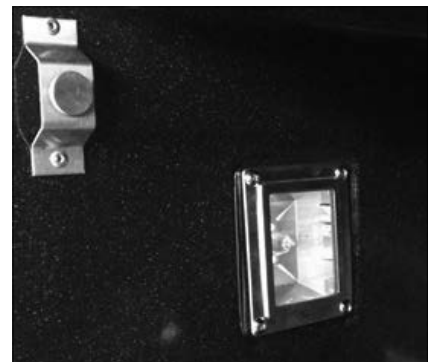

- d. Refit LH side rack as shown previously.

# Cleaning and Maintenance

## Door Seal

- To remove the door seal, pull the 1 piece seal forward until it pulls out of the location groove around the oven.  
**Note the way the seal is fitted to the oven, with the lip facing inwards.**



- Check the door seal for wear and damage and replace as required.
- Wash the door seal in a sink, taking care not to cut or damage the seal.
- Dry the door seal thoroughly.
- Refit the door seal with lip facing into centre of the oven.



- Press the door seal into the locating groove in the front face of the oven until the seal is properly located all around the oven.

## Oven Interior

- Allow the oven interior to cool to approx 50°C / 120°F before commencing cleaning.
  - Remove the oven racks as shown previously.
  - Clean any build up of grease from the oven interior, using a soft bristled brush with a solution of hot water and a mild anti bacterial detergent.
  - Dry the oven thoroughly with a soft dry cloth.
  - Clean the oven regularly with a good quality oven cleaner.

## Door Glass Cleaning

- Ensure that the oven door is cool before cleaning the oven door glass.
  - Open the oven door.
  - Lift up the bottom of the inner glass at the centre of the door to unlock from the inner glass retaining catches and swing the glass inwards towards the oven.

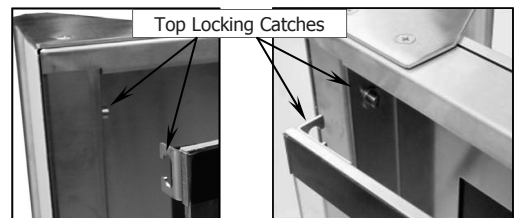
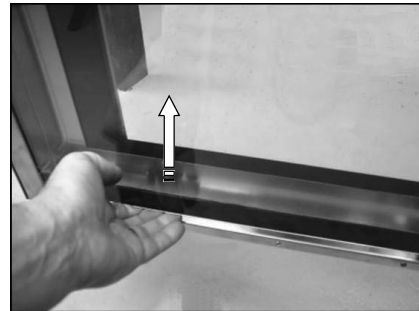

- Clean both sides of the inner glass and the inner side of the outer door glass with a conventional glass cleaner.
- Dry the oven door thoroughly with a soft dry cloth.
- Swing the inner glass back towards the outer door.
- Whilst holding the outer door, lift the inner glass back onto the locking catches until the inner glass is securely held.

## Periodic Maintenance

**NOTE:** All maintenance operations should only be carried out by a qualified service person.

Controls and mechanical parts should be checked and adjusted periodically by a qualified service person. It is recommended that the appliance is serviced every 6 months.

# Fault Finding

This section provides a reference to the more common problems that may occur during the operation of your oven. This fault finding guide is intended to help you correct and accurately diagnose problems with your oven.

You may encounter a problem not covered in this section, please contact your service provider who will require the following information:-

When fault finding a problem, always use a process of elimination starting with the simplest solution and working through to the most complex. Never overlook the obvious.

- **The Model and Serial Number of the oven, can be found on the Technical Data Plate located on the front right hand side panel of the oven.**

Fault	Possible Causes	Remedy
<b>Oven does not operate.</b>	Mains isolating switch, circuit breaker or fuses are Off at the power board.	Turn On.
	Overtemp tripped (No lights, no power light).	Call for service.
	Overtemp faulty.	Call for service.
	Digital Controller faulty	Call for service.
<b>Oven Controller operates but No Heat in Oven.</b>	Element faulty.	Call for service.
	Digital Controller faulty	Refer to 'Digital Controller Fault Codes'. Call for service.
	Door not closed fully (display shows ' <b>dor</b> ').	Close door. (Refer 'Door does not close fully').
	Door Switch faulty (display shows ' <b>dor</b> ').	Call for service.
<b>Oven heats up but Fan does not operate.</b>	Heating Contactor faulty.	Call for service.
	Fan motor faulty.	Call for service.
	Fan or fan motor obstructed.	Call for service.
	Controller faulty.	Call for service.
<b>Oven does not produce moisture.</b>	Fan Contactor faulty.	Call for service.
	Fan Capacitor faulty.	Call for service.
	Moisture Mode not selected.	Check Moisture Mode settings.
	Injector Nozzle blocked.	Call for service.
<b>Door does not close fully.</b>	Water Solenoid faulty.	Call for service.
	Controller faulty.	Call for service.
	Tray in way of door (display shows ' <b>dor</b> ').	Correctly position tray in rack.
<b>Oven light not illuminating.</b>	Door misaligned (display shows ' <b>dor</b> ').	Re-align door.
	Door seal obstruction (display shows ' <b>dor</b> ').	Correctly install door seal. (Refer to 'Cleaning' Section).
	Blown bulb (one bulb not working).	Call for service.
<b>Uneven cooking.</b>	Blown fuse (both bulbs not working).	Call for service.
	Too high a temperature selected.	Select a lower temperature.
	Oven or racks not level.	Check oven racks and level.
	Insufficient air space around trays or baking tins.	Ensure oven racks are spaced to allow air flow around baking on all shelves.
	Oven overloaded with too much product.	Re-load oven.
	Opening oven door un-necessarily.	Ensure oven door is closed during baking.
	Oven door seal damaged or faulty.	Check seals and replace if damaged.
<b>Control Panel does not indicate 'CP' when Core Probe connected.</b>	Oven vent restricted.	Ensure oven vent not blocked or shrouded.
	Core Probe Faulty	Replace Core Probe.
<b>'Err 001' on display.</b>	Oven Probe failure.	Call for service.
<b>'Err 003' on display.</b>	Motor Thermal Cut-Out tripped.	Call for service.
<b>'CP' flashing on Lower Display, alarm sounding, oven program paused.</b>	Core Probe not connected to control panel, and program requires its use.	Connect Core Probe to control panel.
	Core Probe Faulty.	Replace Core Probe.

# Electrical Schematics

## Electrical Schematic E33D5 Turbofan Oven

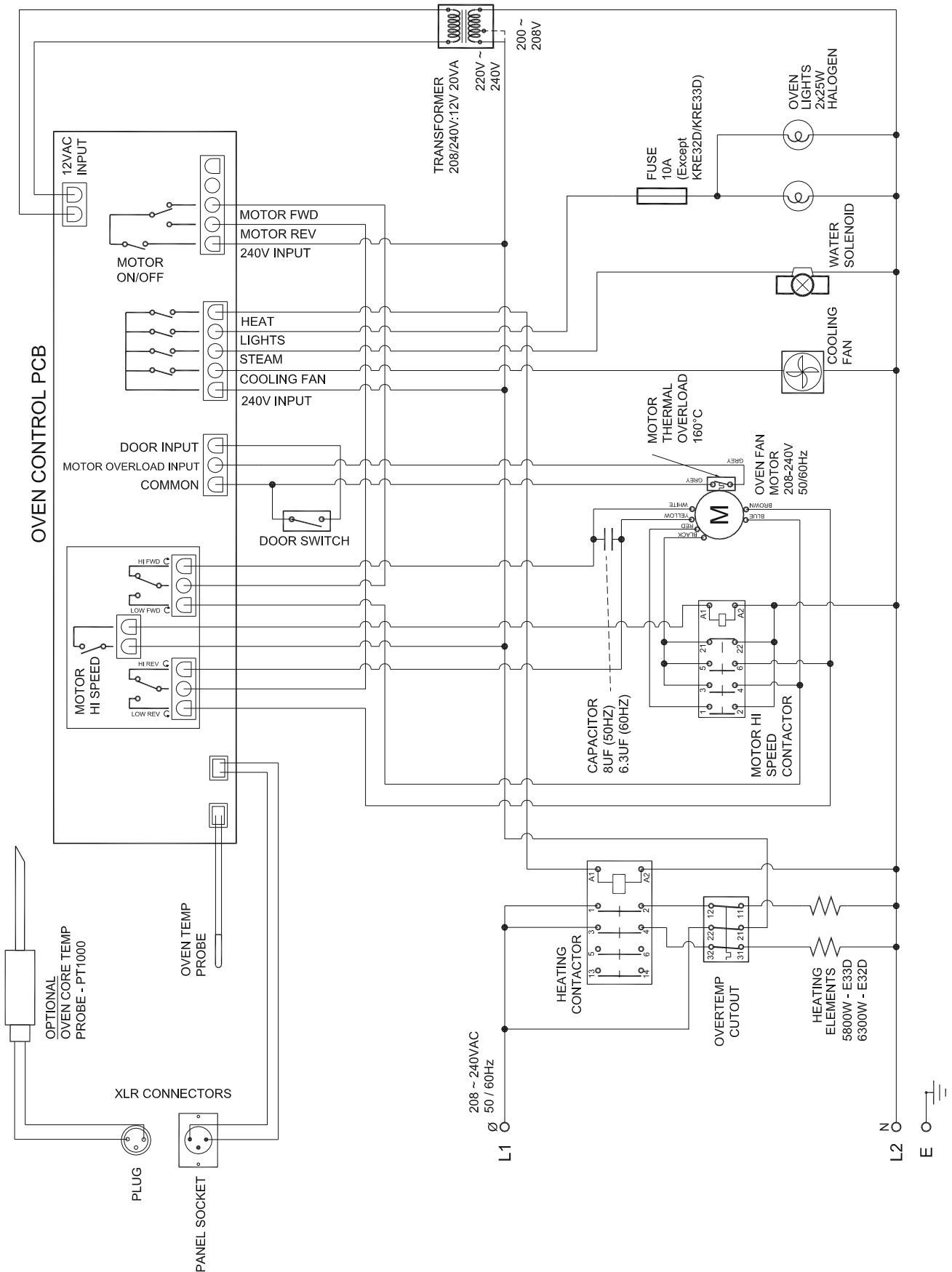

# Replacement Parts List

## Important:

**Only genuine authorized replacement parts should be used for the servicing and repair of this oven. The instructions supplied with the parts should be followed when replacing components.  
For further information and servicing instructions, contact your nearest authorized service provider or Turbofan Dealer.**

When ordering replacement parts, please quote the part number and the description as listed below. If the part required is not listed below, request the part by description and quote model number and serial number which is shown on the Technical Data Plate.

Item	Description
236256	Digital Control Board Kit.
234450	Encoder.
234447	Control Knob.
234429	Transformer, 208 / 240V x 12V AC SEC, 20VA.
234460	Cooling Fan 230V.
237447K	Temperature Probe Kit PT1000
234821	Overtemp Thermostat 355°C / 670°F.
231738	Contactora - Heating.
231742	Contactora - Motor Speed.
236109	Oven Element, 5800W, 230 - 240V.
236110	Oven Element, 5800W, 208 - 220V.
236264	Element Gasket (included in Oven Element Kit).
235625	Fan Motor, 2 Speed.
235610	Motor Shaft Seal.
234138	Fan - Dia 8½" / 220mm.
236053	Motor Capacitor 6.3uF, 60Hz Only.
236054	Motor Capacitor 8uF, 50Hz Only.
021352	Oven Glass Lens.
231814	Lamp Bulb G9 25W, Halogen, 230V.
021354	Oven Lamp Gasket.
234803	Fuse 10A, 250V.
020851	Water Solenoid.
021057	Spray Nozzle Assembly.
235615	Oven Door Seal - E33.
235652	Door Inner Glass Assembly.
235859	Door Handle Assembly.
231804	Single Step Locking Dog.
235851	Door Hinge Set Top
235852	Door Hinge Set Bottom
232379	Foot Adjustable (73 - 80mm).
232380	O-Ring.
235669	Side Rack LH, 5 Tray - E33.
235670	Side Rack RH, 5 Tray - E33.
236057	Oven Rack - E33.

## Optional Extras

Item	Description
236060	Core Temperature Probe Kit.
235845	Core Temperature Probe.
235847	Dust Cap - Core Temperature Socket.
236271	Core Temperature Probe Holder.



