



Easy Wedger™ and Easy Apple Corer™

- N55550-4 4 Section Wedge
- N55550-6 6 Section Wedge
- N55550-8 8 Section Wedge
- N55550-10 10 Section Wedge
- N55550-8C 8 Section Corer

OPERATING AND MAINTENANCE INSTRUCTIONS

Important

1. To get the best operation and life from your machine, please read and comply with these instructions.
2. Clean machine thoroughly before and after each use using cleaning instructions below.
3. Minimize the use of alkaline cleaners as they may cause pitting and dulling of the finish.

Safety Instructions

Remember the blades are **VERY SHARP!** Be careful when handling and operating the machine to keep hands away from the blades.

Preparation

1. Your Easy Wedger™ and Easy Apple Corer™ comes to you fully assembled.
2. Place the unit on a good firm work surface.
3. If unit fails to operate properly when first used call NEMCO customer service at 1-800-782-6761.

Operation

- 1) Lift PUSH BLOCK and place the produce on the BLADE ASSEMBLY.
- 2) Remove hand/fingers from the cutting area and with a strong, quick thrust bring the PUSH BLOCK down to force the produce through the BLADES.
- 3) Clean the machine after wedging is completed using cleaning instructions below.

Cleaning

- 1) Lift PUSHER BLOCK off GUIDE RODS.
- 2) Remove screws from bottom of the FRAME to release the BLADE ASSEMBLY.
- 3) Thoroughly wash the PUSH BLOCK, BLADE ASSEMBLY and the FRAME.
- 4) Reassemble by reversing the procedure.

To Lubricate

When needed, lubricate the GUIDE RODS with mineral oil, food grade grease or rub them with paraffin. DO NOT LUBRICATE WITH COOKING OIL – IT GETS STICKY!

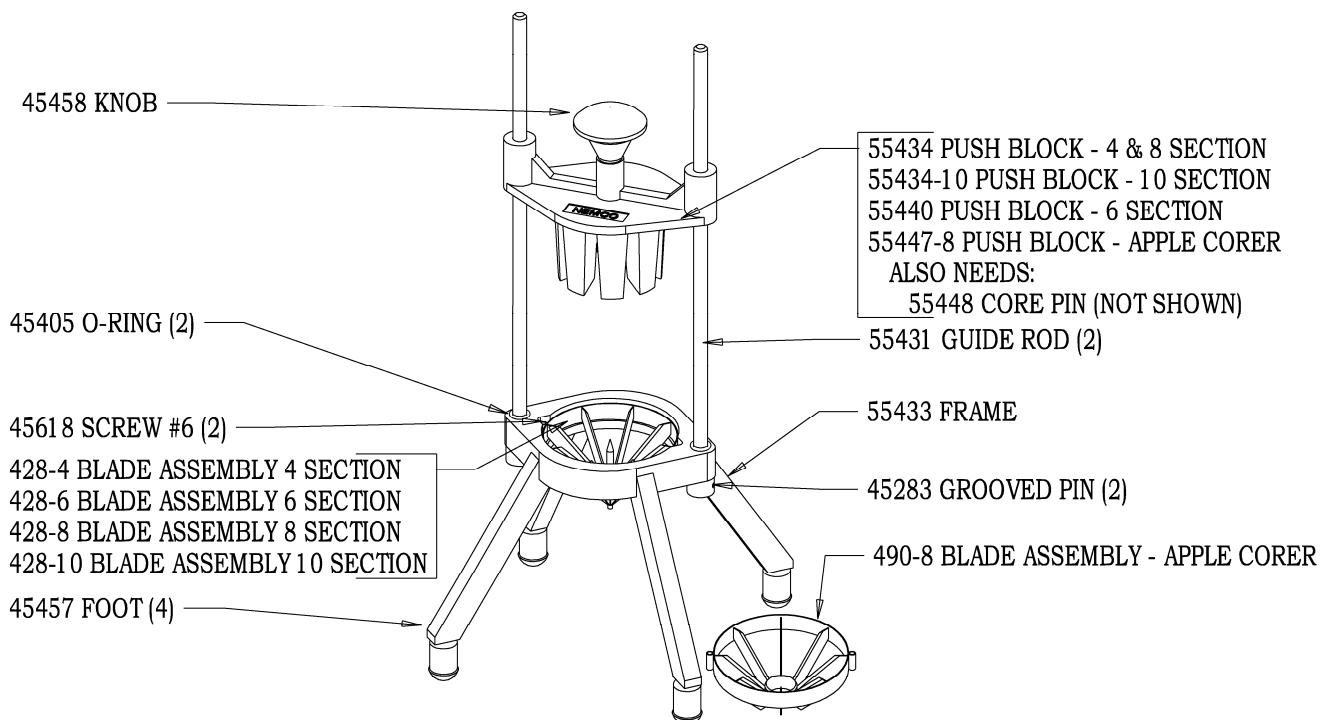

NEMCO FOOD EQUIPMENT

Phone: (419) 542-7751

301 Meuse Argonne, Hicksville, OH 43526

Fax: (419) 542-6690 Toll free: 1-800-782-6761

www.nemcofoodequip.com

46022

9-21-2009