



AUTOMATIC
FOODSERVICE
EQUIPMENT

AUTOMATIC ELECTRIC
BROILER
MODELS 950E and 930E

OWNER'S MANUAL



FOR YOUR SAFETY:

Do not store or use gasoline or other flammable vapors or liquids in the vicinity of this or any other appliance.

IMPORTANT: RETAIN THIS MANUAL IN A SAFE PLACE FOR FUTURE REFERENCE

Broiler area must be kept free of combustible materials, and the flow of combustion and ventilation air must not be obstructed. Operating personnel must not perform any maintenance or repair functions. Contact your Nieco Authorized Dealer.

TABLE OF CONTENTS

A. Machine Installation	3
Pre-Installation	
Mounting	
Hood Requirements	
Clearance	
Electrical Connection	
Pre-Operation Check	
B. Operation	4
Controls and Indicators	
Broil Stabilizer Control	
Conveyor Belt Speed	
Step-by-Step Starting Procedure	
Shutdown Procedure	
C. Assembly/Disassembly and Cleaning	7
D. Periodic Maintenance	9
E. Conveyor Belt Removal	10
F. Conveyor Belt Tension	11
Broil Belt Problems	
G. Parts and Location	12
950	
930	
H. Trouble Shooting Guide	18
I. Wiring Diagram	20
950 Domestic U.S.A.	
950 Export	
930 Domestic U.S.A.	
930 Export	

A. INSTALLATION

PRE-INSTALLATION

Uncrate the broiler, and inspect for shipping damage. Contact the factory if there is obvious damage. Remove the tape securing the machine parts, and install the parts in their proper location. Refer to the Parts and Location section of this manual. If you find concealed damage to any part of this unit, contact your freight carrier immediately. The factory warranty does not cover freight damage.

MOUNTING

If the broiler was shipped with a tubular stand, refer to separate tubular stand assembly instructions.

Note: The four legs of the broiler stand are equipped with casters. Always set the brakes on the casters to prevent the broiler from shifting during operation or cleaning.

Adjust the legs on the broiler and the stand so that the broiler is level.

HOOD REQUIREMENTS

This appliance must be installed under a ventilation hood of adequate size and capacity:

Model 950	800 CFM (1020 CMH)
Model 930	600 CFM (760 CMH)

The hood should be at least 6" (15.2 cm) larger in all dimensions than the appliance top, and be 12" to 18" (30.5 cm - 45.7 cm) above the top. Do not obstruct the flow of combustion and ventilation air. An adequate air supply must be available for safe and proper operation.

Note: See the National Fire Prevention Association booklet on ventilation of cooking equipment. Write to: NFPA, 470 Atlantic Ave., Boston, MA 02210. Local codes on venting must also be complied with.

CLEARANCE

For proper installation, the minimum clearance from combustible and non-combustible construction is 6" (15.2 cm) from the back and 6" (15.2 cm) from the front of the machine. Keep appliance area free from combustibles.

To facilitate disassembly and service of the unit a minimum of 24" (61 cm) should be allowed on the front of the broiler as well as the left side.

ELECTRICAL CONNECTION

Power requirements are stated on the unit nameplate and must be connected accordingly. Before starting broiler, tighten all electrical connections in control box.

Note: This appliance must be electrically grounded in accordance with local codes or in the absence of local codes, the National Electrical Code, ANSI/NFPA No. 70-1990. In Canada, in accordance with the Canadian Electrical Code CSA 22.1 part 1, or local codes.

WARNING: This appliance should be connected with a five-pronged grounding plug for your protection against shock hazard. Be sure to plug directly into a properly grounded five-prong receptacle. Do not cut or remove grounding prong from plug.

Note: This appliance cannot be safely operated in the event of a power failure. No attempt should be made to operate during a power failure. Disconnect power supply before servicing.

PRE-OPERATION CHECK

Be sure that all parts are installed in the proper location. Refer to **OPERATION** section for lighting procedure. Start broiler and test for proper operation.

B. OPERATION

CONTROLS AND INDICATORS

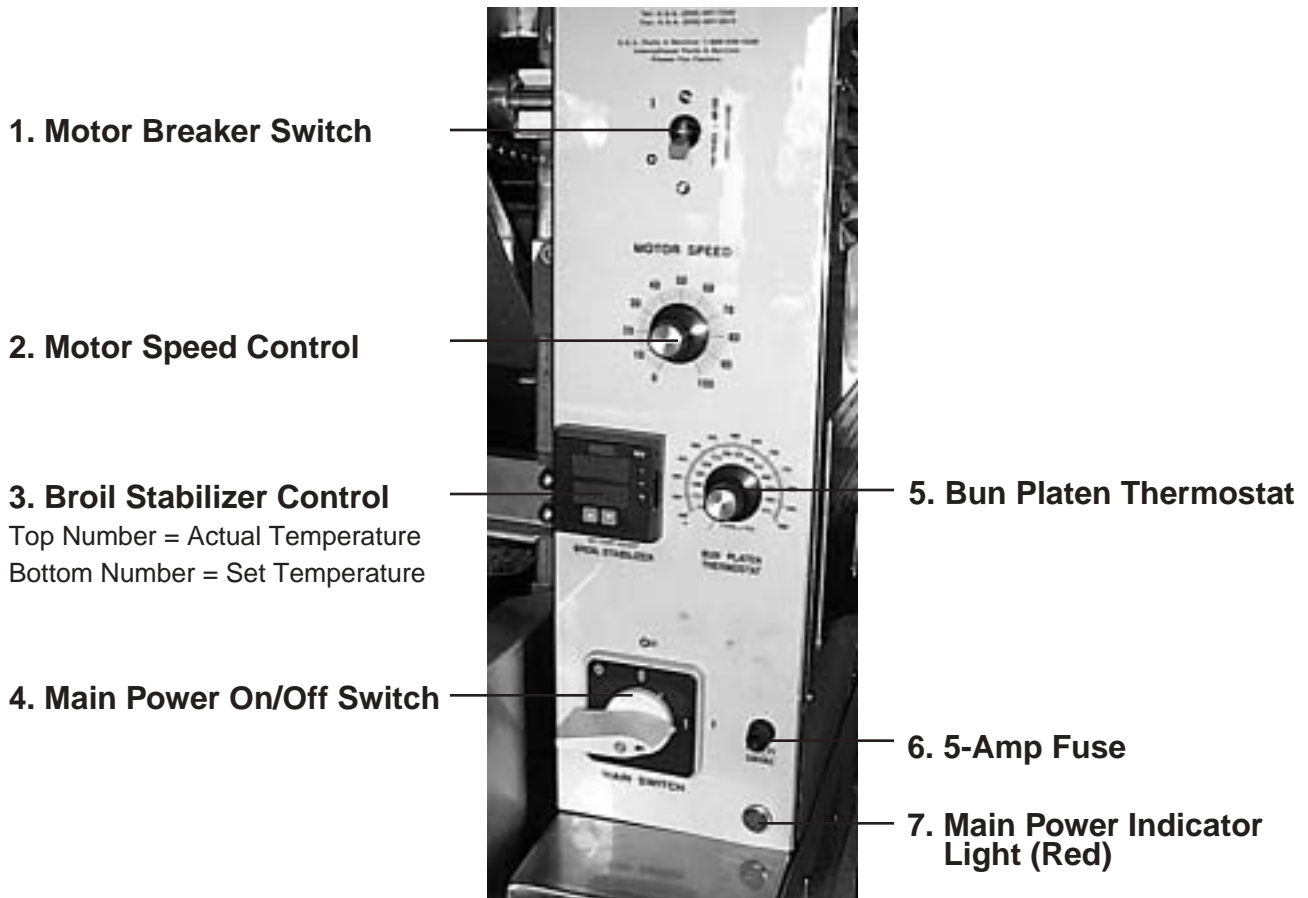

CALIBRATING THE BROIL STABILIZER CONTROL

The 950 & 930 Electric broilers are equipped with a Broil Stabilizer Control that senses when the broiler is cooking, and increases the temperature when in use. Refer to calibration instructions in this manual or on the metal label plate on the control box of the broiler. The red light on the control may flash during normal operation. No daily adjustment of the Broil Stabilizer Control is necessary.

FOOD PRODUCT SAFETY

The Nieco broiler is designed to cook food consistently. Careful setting of the conveyor belt speed is necessary for proper performance. Always test the product to be sure it is cooked properly every day. Follow established guidelines for food safety and handling.

BROIL TEMPERATURE STABILIZER CONTROL

Electric broilers are equipped with a Broil Temperature Stabilizer Control that senses when the broiler is being used, and adjusts the temperature to keep the broiler hot during heavy use. The control consists of two parts - a temperature probe to sense the internal temperature of the broiler, and the control itself.

CALIBRATING THE BROIL STABILIZER CONTROL

In order to assure proper operation, the Broil Stabilizer Control must be calibrated for operation in the restaurant. Every broiler will calibrate slightly differently, depending on supply voltage, ventilation, etc. Follow these step by step instructions when the broiler is new, and once per month after.

- Step 1: Be sure all pieces of the broiler are in place. Make sure the broiler is plugged in and the exhaust hood is turned on. Turn the broiler on by turning the main power switch to the right. Turn on the conveyor belts using the motor breaker switch.
- Step 2: Set the temperature (bottom number) to 200° F. Use the up or down arrows on the control to set the temperature. The bottom number is the set temperature and the top number is the actual temperature.
- Step 3: Allow the broiler to heat up for 40 minutes. During this time, the actual temperature will climb. Wait until the actual temperature stabilizes before proceeding.
- Step 4: Set the ATC (bottom number) to 200° F higher than the actual temperature. For example, if the broiler stabilizes at 700° F, then the proper setting should be 900° F.

WARNING

The broiler can be damaged if this control is not set according to instructions.

TROUBLE SHOOTING ERROR MESSAGES

Message	Action
ER 4	Turn power on and off several times. If the message remains, replace control. If the message disappears, the control may need to be reprogrammed. Call Nieco or your local distributor for instructions.
ER 6	Cycle power on and off several times. If message remains, replace temperature probe (P/N 4073).

STEP-BY-STEP STARTING PROCEDURE

Before starting broiler, be sure that all parts are installed in the proper location, and the ventilation hood is turned on.

1. Turn on Main Power Switch **(A)**.

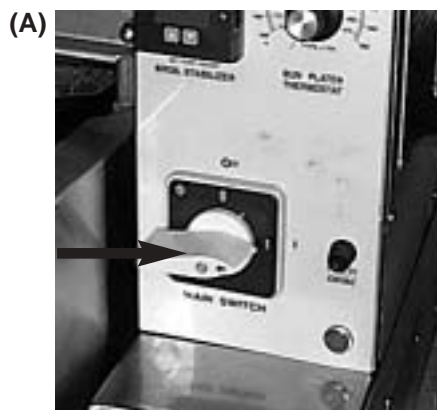

2. Turn on Motor Switch **(B)**.

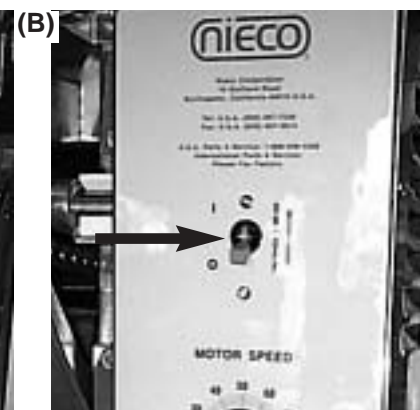

3. Set Motor Speed Control knob to desired setting **(C)**.

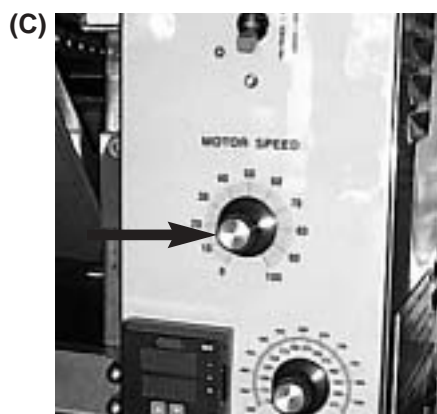

4. Set the Bun Platen Thermostat to the desired setting **(D)**. Use a setting of 230° C (450° F) to start.

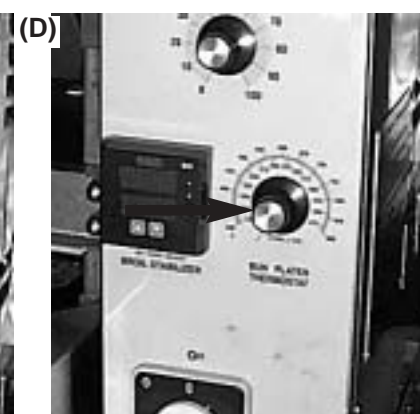

Allow the broiler 30 minutes to warm-up.

NOTE: FOR INITIAL START-UP REFER TO THE BROIL STABILIZER CALIBRATION INSTRUCTIONS.

SHUTDOWN PROCEDURE

For **EMERGENCY** Shutdown, turn the Main Power Switch off. Turn switch counter-clockwise.

For planned shutdowns, perform the following procedure:

1. Clear machine of all food products.
2. Turn Main Power Switch off.
3. Turn Motor Switch off.

CAUTION: Always turn machine completely off before unplugging power cord.

CAUTION: Allow machine to cool before removing any parts.

C. ASSEMBLY / DISASSEMBLY AND CLEANING

TURN OFF POWER BEFORE BEGINNING CLEANING AND DISASSEMBLY

Clear machine of all food products. Allow the machine to run empty for ten minutes in order to burn off the residue on the belt. Turn Main Power and Motor switches off. Allow the machine to cool before beginning disassembly.

D.1 Daily Cleaning

1. Remove the Side Panels by lifting up and off **(A)**. Wipe clean with a degreaser.

(A)



(B)



FROM THE FEED END OF THE BROILER

2. Remove the Incendalyst Awning by releasing the finger tabs **(B)**.

2. Remove the Patty Feeder by lifting up and out **(C)**. Clean daily by using soap and water.

(C)



(D)



3. Remove the Grease Pan by sliding it out the front **(D)**. Clean daily by using soap and water.

4. Remove the Belt Scraper **(E)**. Notice the position it sits in before removing, so that you can replace it properly. Clean daily by using soap and water or degreaser.

(E)



(F)



5. Scrape the shafts with the special tool provided or with a flat head screwdriver **(F)**.

6. Remove the Lower Heat Reflector **(G)**.

(G)



(H)

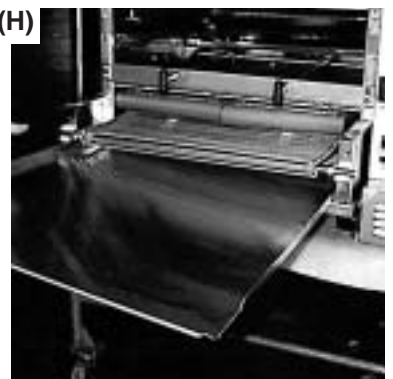

7. Remove the Crumb Tray **(H)**.

FROM THE LEFT SIDE OF THE BROILER

8. Remove the Left Side Panel **(I)**.
9. Remove the Grease Chute and Grease Pan **(J)**.

(I)



(J)



FROM THE DISCHARGE END

10. Remove Discharge End Incendalyst Awning **(K)**.
11. Remove the Stripper Blade **(L)**- NOTE: Lower Heat Reflector must be slid forward or removed in order to remove the Stripper Blade.
12. Remove the Patty Catch Pan and Insert **(M)**.
13. Remove the Bun Blade **(N)**.

(K)



(L)



(M)



(N)



FROM THE TOP OF THE BROILER

14. Remove the Upper Heat Reflectors **(O)**.

(O)



Clean all parts using ONLY a Burger King approved degreasing agent. Sanitize all food contact parts.

D. PERIODIC MAINTENANCE

Note: Maintenance should be performed by authorized personnel only. Always disconnect the power before performing any maintenance on the broiler.

Check the heating elements periodically for signs of wear. Rotating the top and bottom elements every 6 months will increase the life of the elements, and improve the performance of the broiler.

The motor uses carbon brushes that will eventually wear out. Replace the brushes if there is excessive noise or erratic performance from the motor.

Variations in supply voltage can affect the temperature of the broiler. Overfired elements can cause performance problems and warping. Heating elements are available in different voltages, so adjustments to cooking performance are made by using different voltage elements. Contact your distributor for more information.

Always keep the control box clean and free of grease. Do not spray anything on the controls.

E. CONVEYOR BELT REMOVAL

Before beginning, notice the way the belt runs through the broiler. Also notice the direction the knuckles face. Be sure to re-assemble in the same way.

1. Run belt until the Master Link is

1

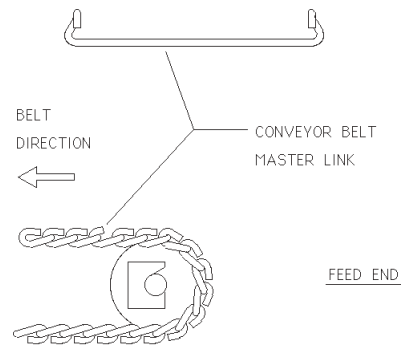

near the front idler shaft.

2. Lift shaft and Teflon Blocks up, and slide the blocks out.

2



3. Unhook the Master Link.

3



To reassemble, reverse the procedure. Be sure to reassemble the belt with the knuckle opening facing away from the direction of travel.

F. CONVEYOR BELT TENSION

Maintain proper tension on the conveyor belts to prevent jamming. Bearing spacers (pictured below) are supplied with the broiler to make minor tension adjustments. Major tension adjustments are made by removing a link or links from the belt.

The diagram on the left shows the spacer in the stored position. The diagram on the right shows the spacer behind the teflon bearing tightening the belts.

Belt tension should be checked monthly. To do this, allow the machine to cool, then grip the idler shaft at each end and pull on it. If the shaft and bearings move $\frac{3}{16}$ " or more, the spacers should be placed behind the bearings to tighten the belts. If the spacers are already behind the bearings, return them to the stored position and remove a link from the conveyor belt.

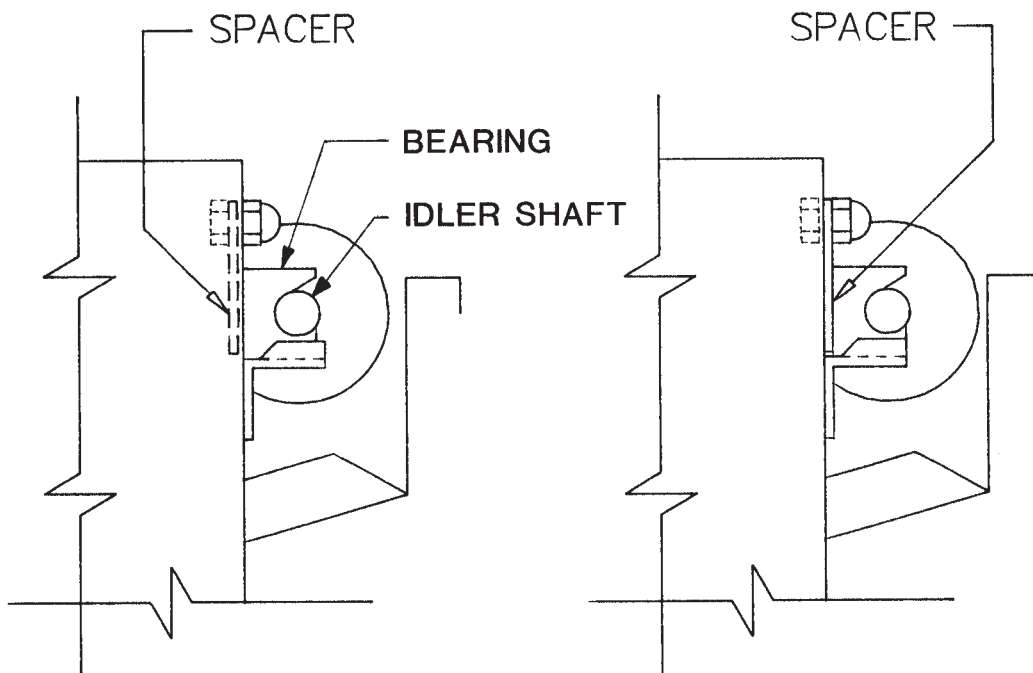

BROIL BELT PROBLEMS

Interference with stripper blade:

The most common belt problem to be expected is the physical interference of the belt with the stripper blade. This is caused by bent or warped rods, or loose belt, and can be fixed by replacing the rods that are causing the problem. Other causes are bent stripper blades, or utensils jammed in the belt.

Blocked belts:

When trouble shooting drive problems, it is important to ensure that the belt is not being blocked. To do this, detach the drive chain and turn the meat belt by hand. The belt, with the motor detached, should turn freely and easily. If the blockage has occurred which is preventing the belt from turning, the blockage should be removed before the drive chain is re-attached. The drive chain can be easily removed from the drive sprocket (on the motor shaft) by loosening the mounting bolts and raising the motor.

G. PARTS AND LOCATION

Models 950 Electric - Feed End View

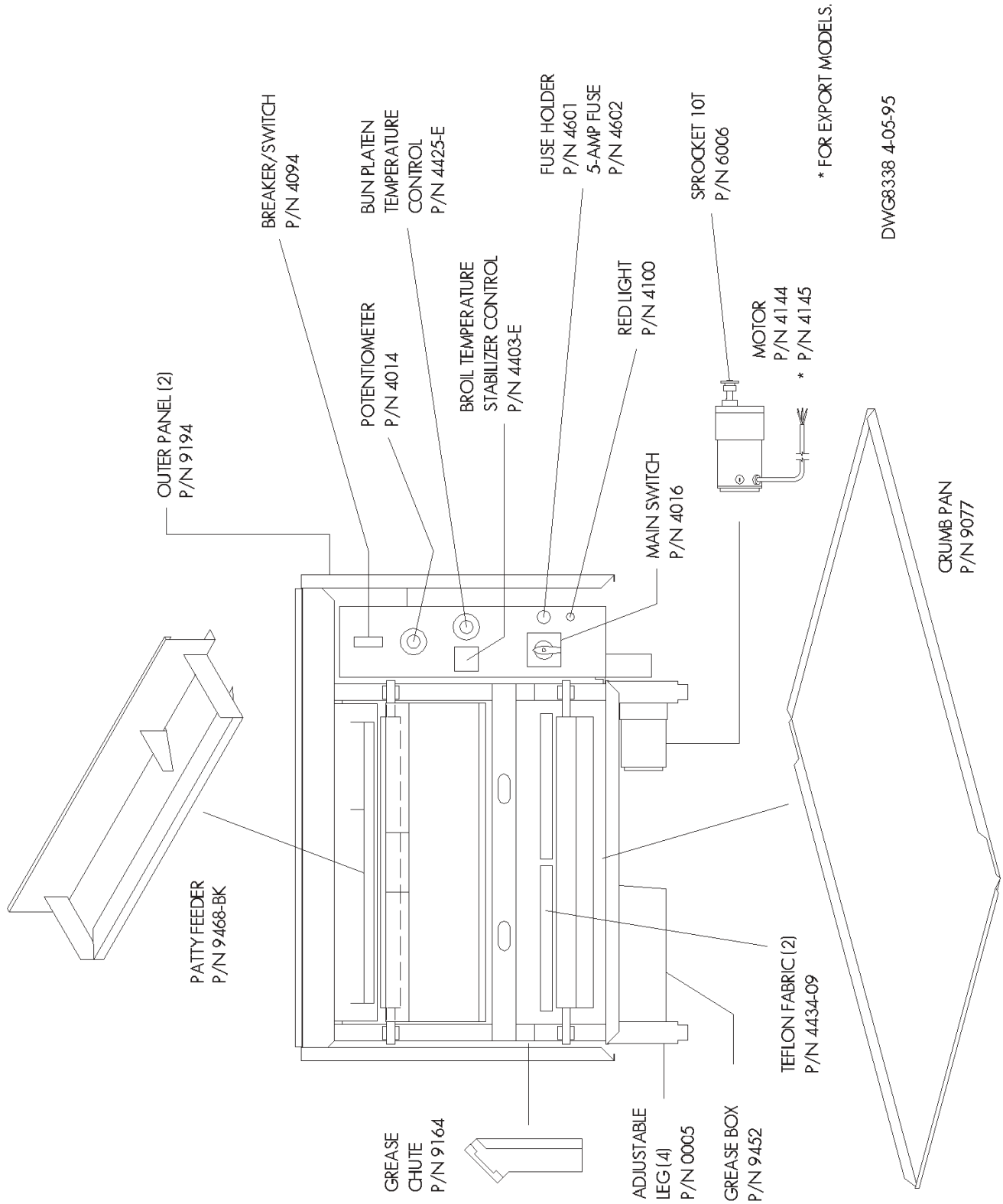

PARTS AND LOCATION

Models 950 Electric - Left Side View

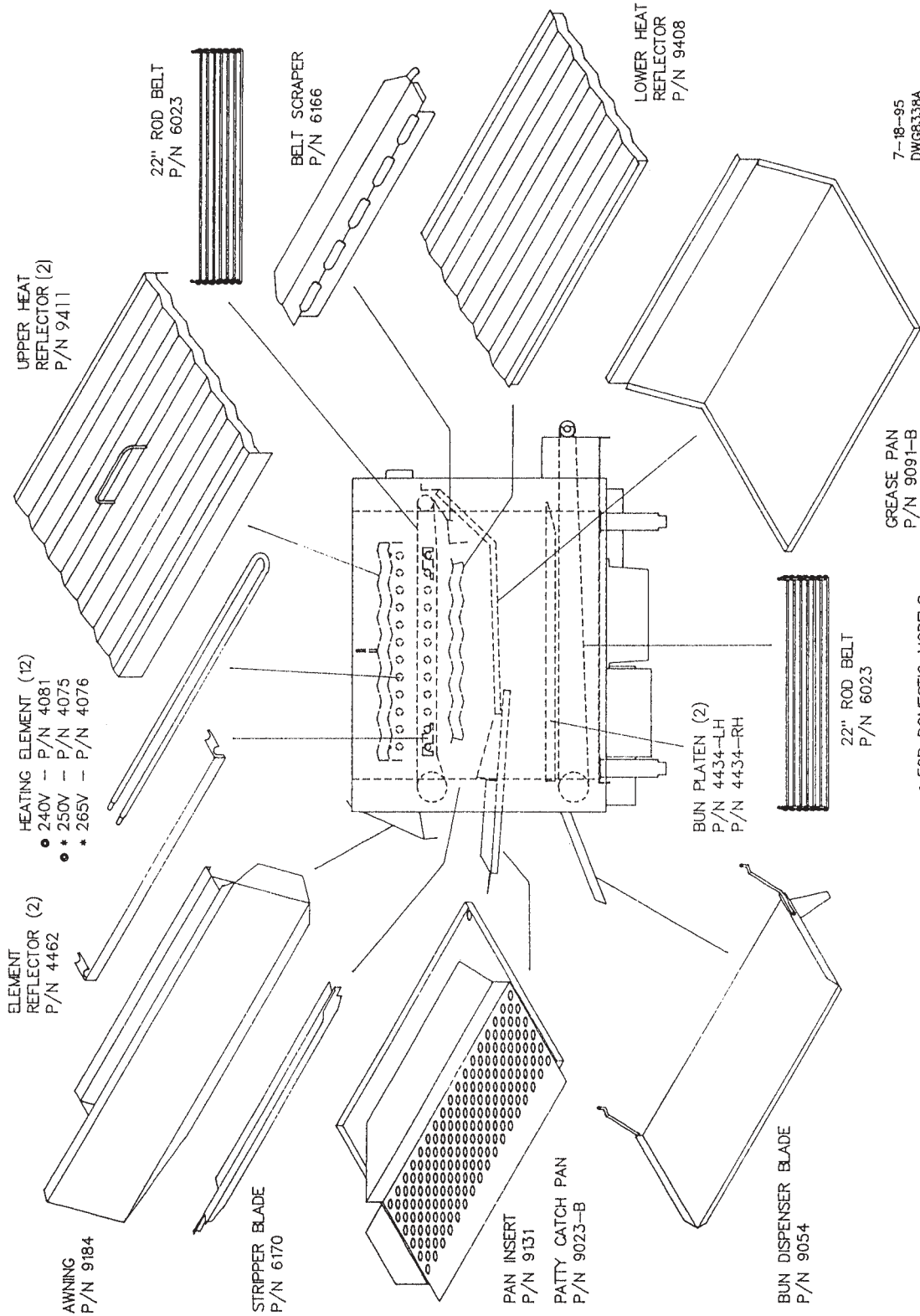

7-18-95
DW68338A

• FOR DOMESTIC MODELS.
 * FOR EXPORT MODELS.

REGISTERED NECO CORP., 1995

PARTS AND LOCATION

Models 950 Electric - Right Side View

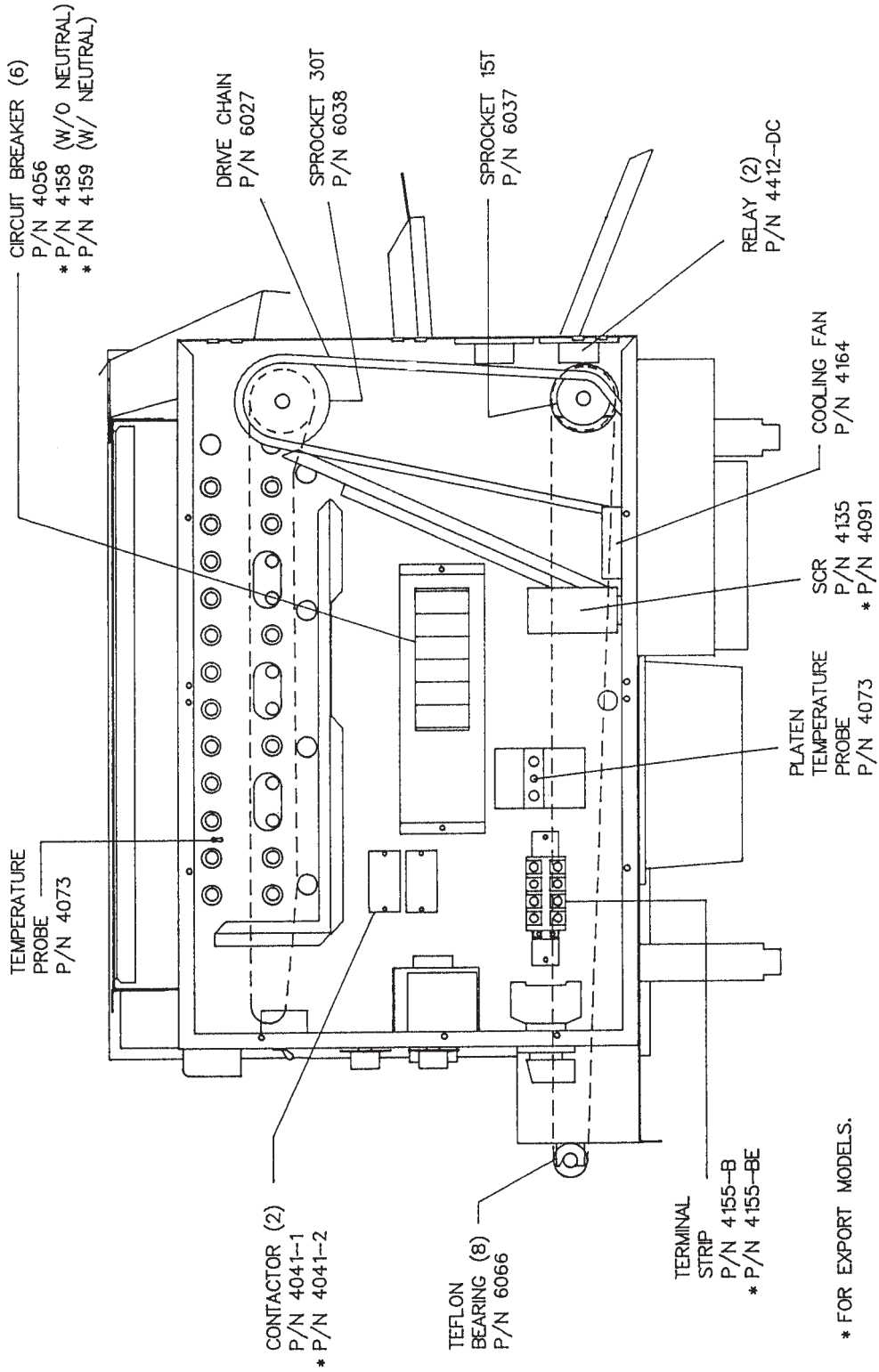

PARTS AND LOCATION

Models 930 Electric - Feed End View

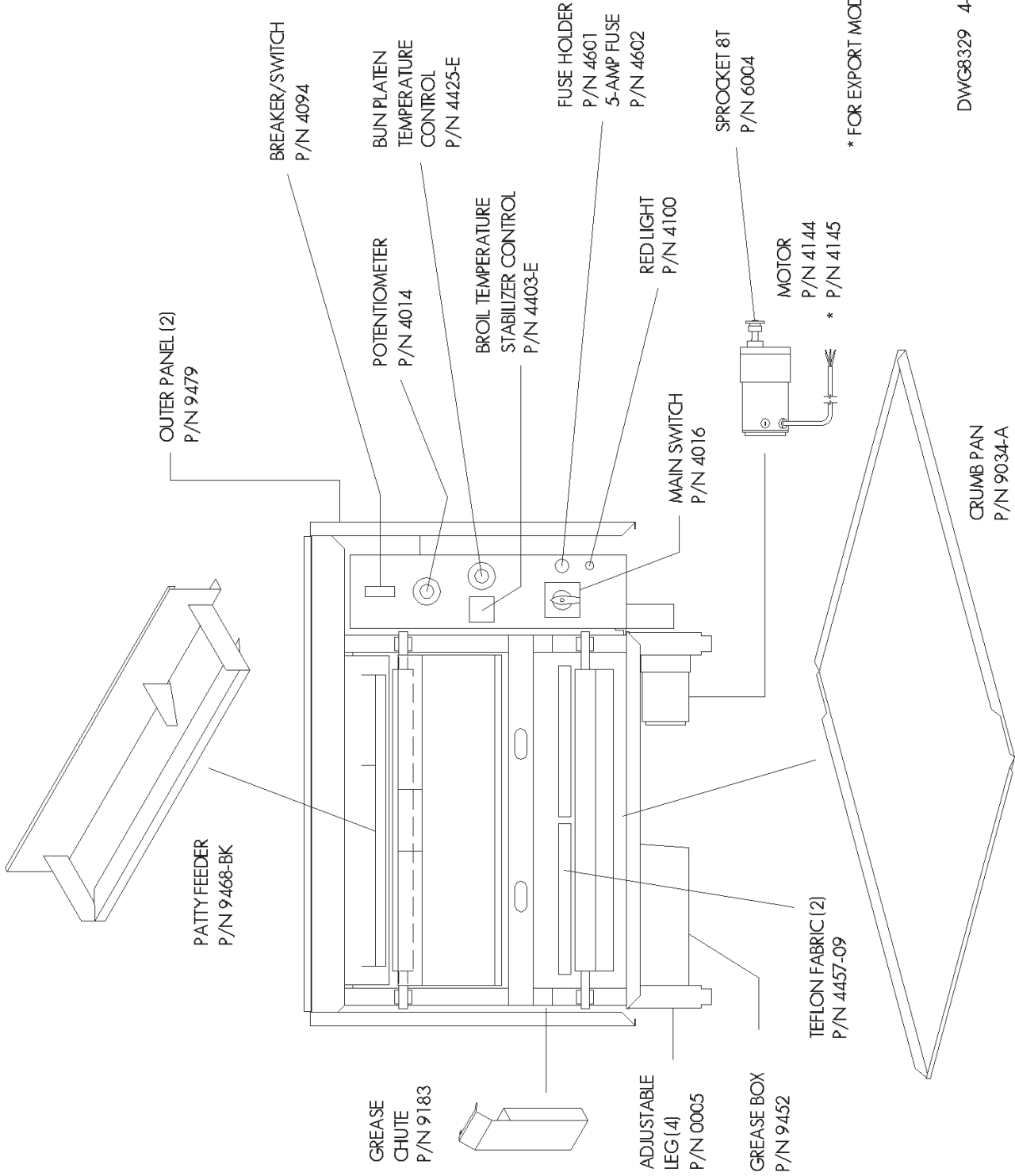

DWG8329 4-05-95

PARTS AND LOCATION

Models 930 Electric - Left Side View

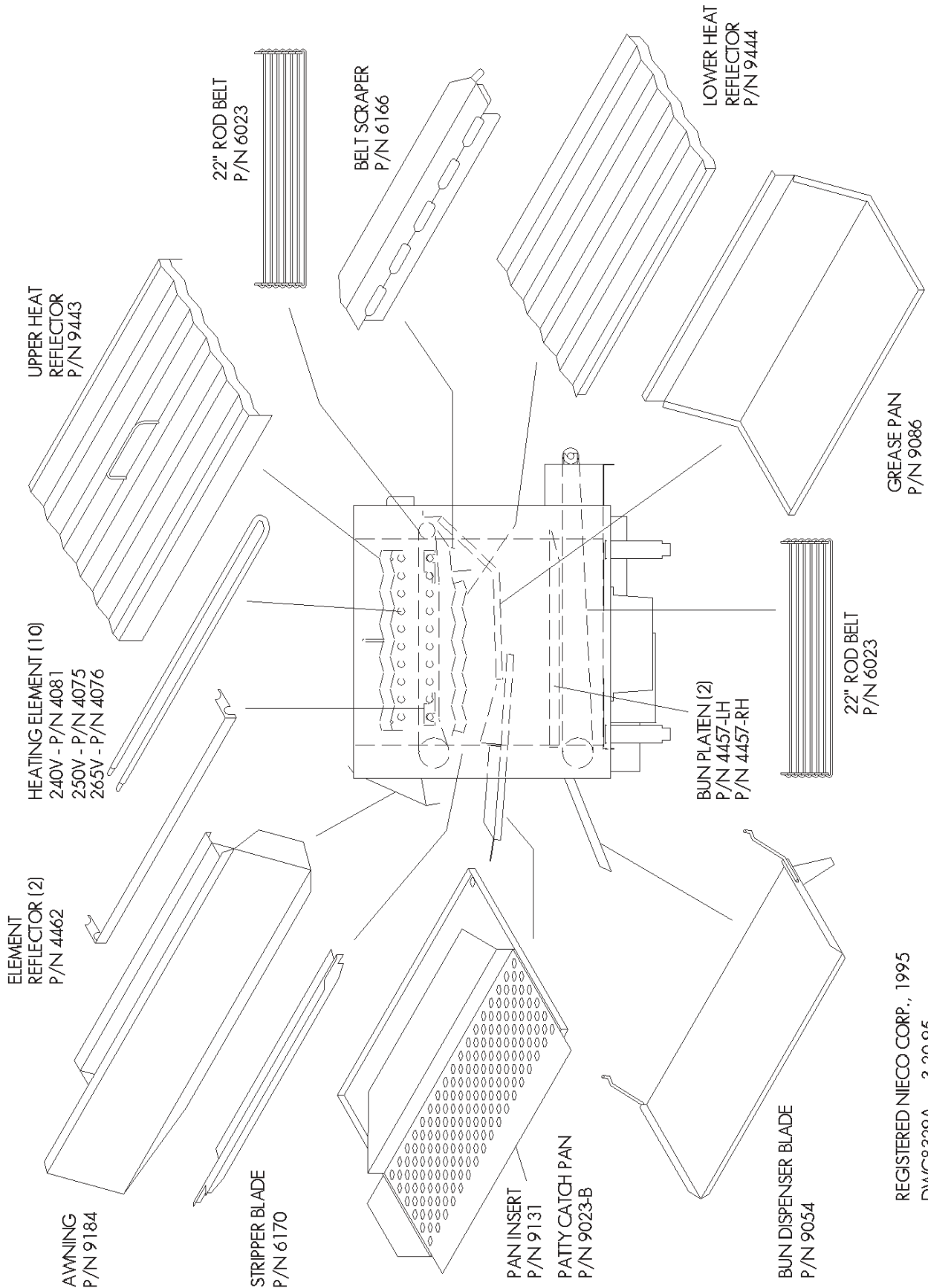

REGISTERED NIECO CORP., 1995
DWG8329A 3-20-95

PARTS AND LOCATION

Models 930 Electric - Right Side View

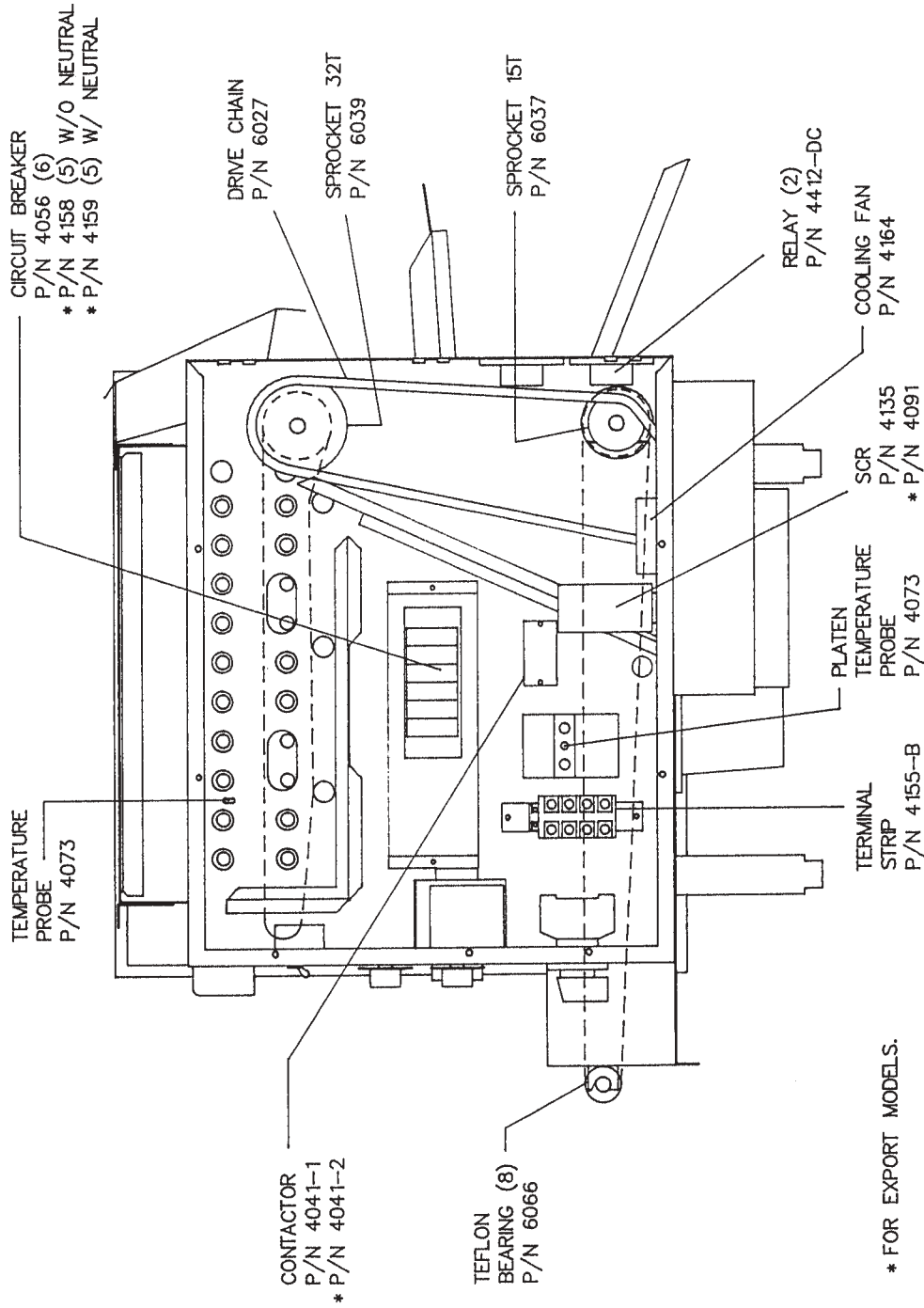

REGISTERED MECO CORP., 1995 DWG8329B 12-20-95

H. TROUBLE SHOOTING GUIDE

Identify the problem in the left column, and look for probable causes and solutions in the right hand columns. Probable causes are listed in "most likely to happen" order. This sequence should be used to isolate the problem. Once the cause is found, refer to OPERATION and PARTS AND LOCATION sections for explanation of function or repair part needed. Wiring diagram is located inside electrical control box cover.

PROBLEM	PROBABLE CAUSE	SOLUTION
1. All elements go out or fail to heat up.	<ol style="list-style-type: none"> 1. Unit not plugged in properly. 2. Breaker switch on wall panel tripped. 3. Broiler circuit breakers tripped. 4. Broiler on/off switch defective. 	<ol style="list-style-type: none"> 1. Plug in properly. 2. Reset circuit breaker. 3. Reset circuit breaker inside control box. 4. Replace.
2. Some elements are on, but others refuse to heat.	<ol style="list-style-type: none"> 1. Defective element. 2. Circuit breaker tripped. 3. Loose or broken wire. 	<ol style="list-style-type: none"> 1. Replace. 2. Reset. 3. Check all wires. Tighten or replace.
3. Elements appear hotter or colder than usual.	<ol style="list-style-type: none"> 1. Supply voltage is different than the element ratings. 	<ol style="list-style-type: none"> 1. Correct supply voltage or install elements that are rated for the supply voltage.
4. Bun Platen won't heat.	<ol style="list-style-type: none"> 1. Unit not plugged in properly. 2. Wall circuit breaker tripped. 3. Defective thermostat/temperature controller or relay contactor. 4. Loose or broken wire. 5. Temperature set too low. 	<ol style="list-style-type: none"> 1. Plug in properly. 2. Reset circuit breaker. 3. Replace. 4. Check all wires. Tighten or replace. 5. Increase setting on digital display.
5. Conveyor belts won't advance.	<ol style="list-style-type: none"> 1. Conveyor belt jammed. 2. Machine not plugged in properly. 3. Wall circuit breaker tripped. 4. Motor control switch off. 5. Motor speed dial turned to zero. 6. SCR unplugged or defective. 7. Drive chain broken. 8. Drive sprocket loose. 9. Gear motor defective. 10. Speed pot defective. 11. Loose or broken wire. 12. Motor unplugged. 13. Defective plug or receptacle. 	<ol style="list-style-type: none"> 1. Remove jam. Reset motor switch. 2. Plug in properly. 3. Reset circuit breaker. 4. Turn on. 5. Increase setting. 6. Plug in or replace. 7. Repair or replace. 8. Tighten set screw on the sprocket. 9. Replace. 10. Replace. 11. Check all wires. Tighten or replace. 12. Plug in. Check for grease or dirt in the socket. 13. Replace. Motor can be wired directly to SCR base.
6. Motor control switch trips.	<ol style="list-style-type: none"> 1. Conveyor chains jammed. 2. SCR defective. 3. Motor brushes worn out. 4. Drive chain binding. 5. Shorted wire to motor. 6. Motor defective. 7. Switch defective. 	<ol style="list-style-type: none"> 1. Remove jam. Reset motor switch. 2. Replace. 3. Replace. 4. Adjust chain tension. Lubricate. 5. Repair wire. 6. Replace. 7. Replace.

PROBLEM	PROBABLE CAUSE	SOLUTION
7. Conveyor speeds are erratic.	<ol style="list-style-type: none"> 1. SCR loose or defective. 2. Speed control pot defective. 3. Drive chain binding. 4. Gear motor defective. 5. Loose drive sprockets. 	<ol style="list-style-type: none"> 1. Plug in or replace. 2. Replace. 3. Adjust chain tension. Lubricate. 4. Replace. 5. Tighten set screws on sprocket.
8. Broiled product over or under cooked.	<ol style="list-style-type: none"> 1. Wrong conveyor belt speed. 2. Incorrect elements installed. 	<ol style="list-style-type: none"> 1. Adjust motor speed. 2. Match the voltage rating of the elements to the supply voltage.
9. Broiled product sticks to conveyor belt.	<ol style="list-style-type: none"> 1. Stripper blades not adjusted or installed properly. 2. Product under broiled. 3. Elements too cool. 4. Heat reflectors not installed or installed improperly. 	<ol style="list-style-type: none"> 1. Adjust or install properly. 2. Decrease motor speed. 3. Check elements. 4. Refer to Parts & Location section for proper placement of reflectors.
10. Inconsistent broil.	<ol style="list-style-type: none"> 1. Conveyor speed erratic. 2. Incoming product temperature erratic. 3. Air condition vent blowing on broiler. 4. Erratic voltage supply. 5. Supply voltage incorrect. 6. Broil Stabilizer Control failure. 	<ol style="list-style-type: none"> 1. See #7 above. 2. Check freezers for proper operation. 3. Redirect air away from broiler. 4. Check supply. Contact electric company if there are problems. 5. Match the supply voltage with the element ratings. 6. Check probe and control.
11. Broiler frame or parts warping.	<ol style="list-style-type: none"> 1. Elements too hot. 	<ol style="list-style-type: none"> 1. Match supply voltage to element rating plate on the broiler.

I. WIRING DIAGRAM

Model 950 Electric / Domestic (U.S.A.)

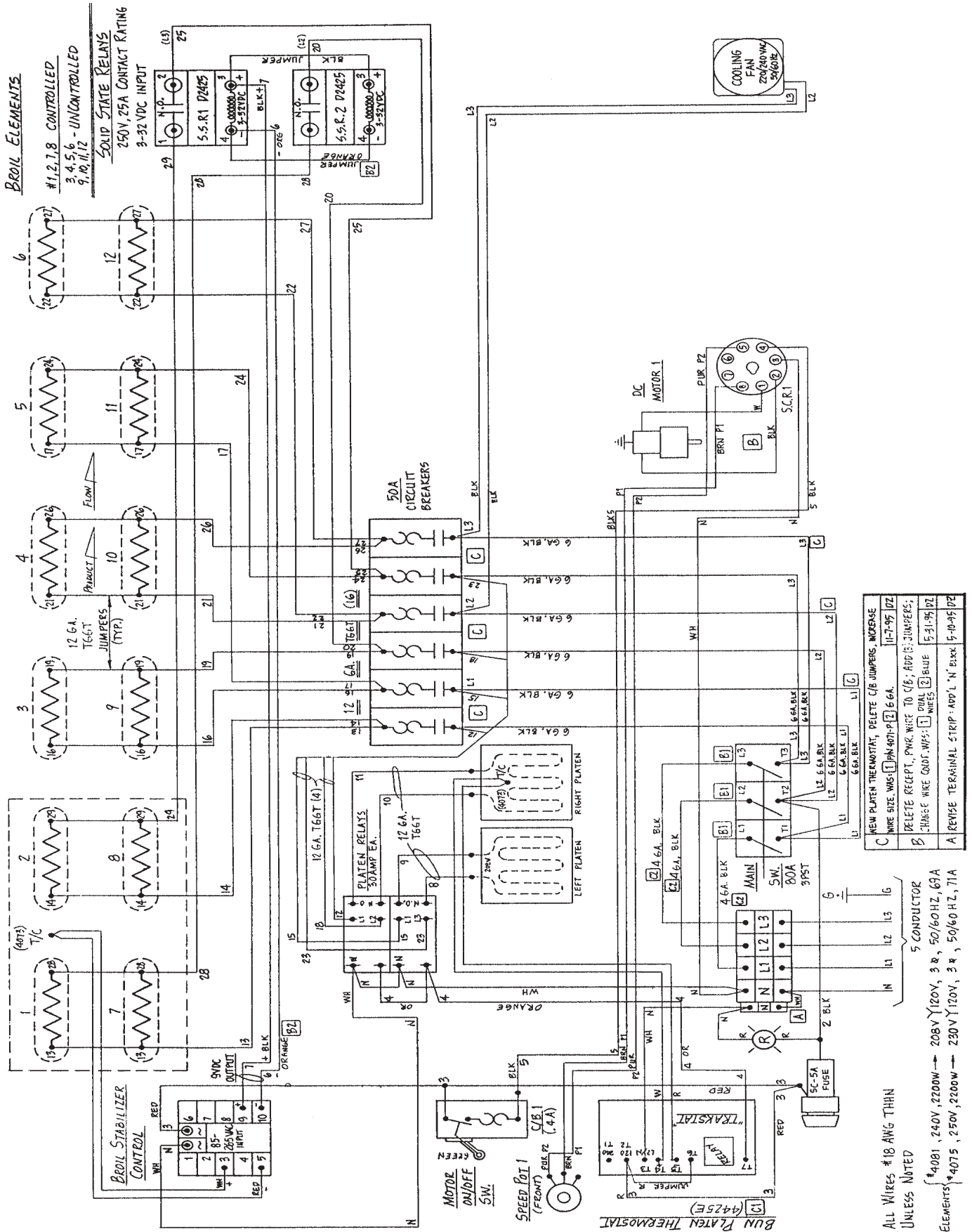

ALL WIRES #18 AWG THIN UNLESS NOTED

4-0081, 240V, 2200W → 208V Y 120V, 3 R, 50/60 HZ, 60A
 4-0075, 250V, 2200W → 230V Y 120V, 3 R, 50/60 HZ, 71A

WIRING DIAGRAM

Model 930 Electric / Domestic (U.S.A.)

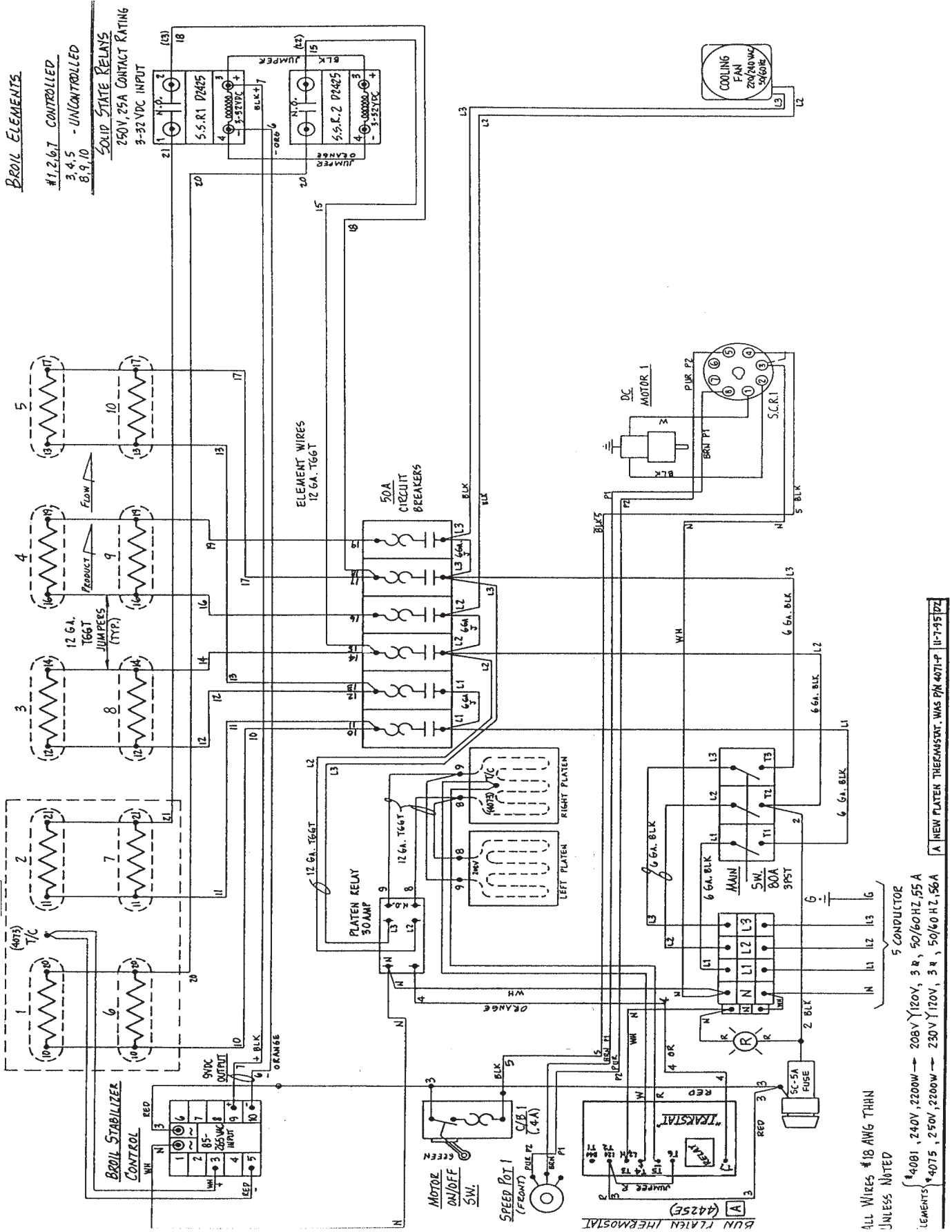

WIRING DIAGRAM

Model 930 Electric / International (Export)

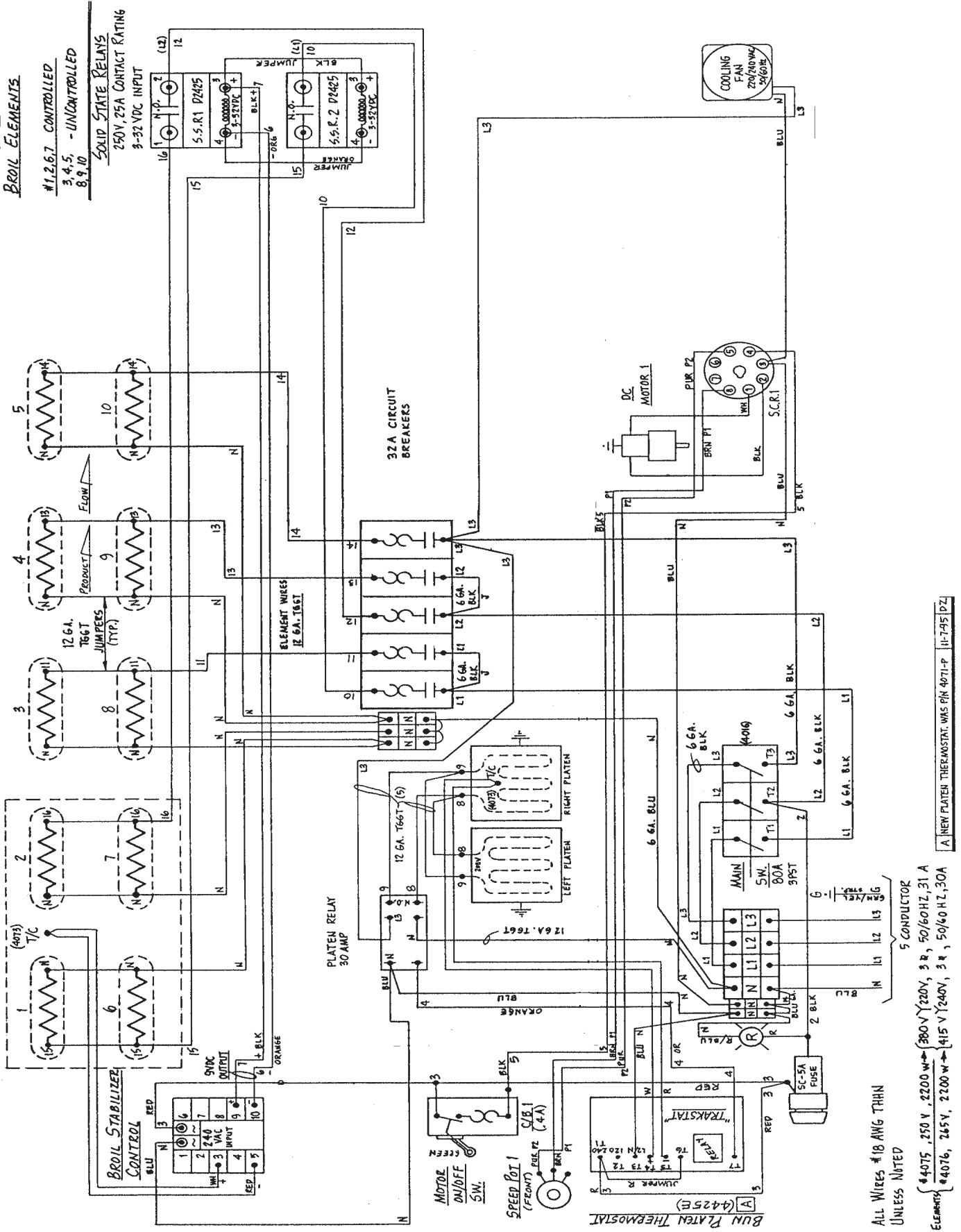



Nieco Corporation • 15 Guittard Rd. • Burlingame, CA 94010 • (650) 697-7335 • Fax (650) 697-3014
Reorder # 9999-99099 11/99 <http://www.nieco.com> nieco@nieco.com Printed in the USA