

# BroilVection™

## Model JF64-3 Gas Owner's Manual



**APPROVALS:**



**FOR YOUR SAFETY:**

Do not store or use gasoline or other flammable vapors or liquids in the vicinity of this or any other appliance.

**WARNING:**

Improper installation, adjustment, alteration, maintenance can cause property damage, injury, or death. Read the installation, operating and maintenance instructions thoroughly before installing or servicing this equipment.

Broiler area must be kept free of combustible materials, and the flow of combustion and ventilation air must not be obstructed. Operating personnel must not perform any maintenance or repair functions. Contact your Nieco Authorized Dealer.

**IMPORTANT: RETAIN THIS MANUAL IN A SAFE PLACE FOR FUTURE REFERENCE**

# TABLE OF CONTENTS

<b>A. General Information</b>	<b>3</b>
A.1 Description	3
A.2 Warranty Information	3
A.3 Service/Technical Assistance	4
A.4 Safety Information	4
<b>B. Machine Installation</b>	<b>6</b>
B.1 Pre-Installation	6
B.2 Mounting	6
B.3 Leveling	6
B.4 Hood Requirements	6
B.5 Clearance	6
B.6 Gas Connection	7
B.7 Flexible Gas Line Installation	7
B.8 Restraining Device	8
B.9 Electrical Connection	8
B.10 Pre-Operation Check	8
<b>C. Operation</b>	<b>9</b>
C.1 Controls and Indicators	9
C.2 Step-by-Step Lighting Procedure	10
C.3 Shutdown Procedure	11
C.4 Control Operation	12
<b>D. Assembly/Disassembly and Cleaning</b>	<b>13</b>
<b>E. Troubleshooting Guide</b>	<b>25</b>
<b>F. Parts Location Drawings</b>	<b>26</b>
<b>G. Parts Replacement List</b>	<b>28</b>
<b>H. Wiring Diagrams</b>	<b>31</b>
<b>I. Specifications</b>	<b>32</b>

# A. GENERAL INFORMATION

## A.1 Description

The Nieco® Model JF64-3G automatic broiler features high release convection burners, Patent pending BroilVection™ air system that uses waste heat to greatly reduce energy needs, easy cleaning and a simple and intuitive control package to help eliminate broiling problems and provide the operator with even greater control over the broiling environment.

This manual provides the safety, installation and operating procedures for the Nieco Automatic Broiler Model JF64-3G. We recommend that all information contained in this manual be read prior to installing and operating the broiler.

## A.2 Warranty Information

Please read the full text of the limited Warranty in this manual.

If the unit arrives damaged, contact the carrier immediately and file a damage claim with them. Save all packing materials when filing a claim. Freight damage claims are the responsibility of the purchaser and **ARE NOT** covered under warranty.

The warranty **does not** extend to:

- Damages caused in shipment or damage as a result of improper use.
- Installation of electrical service.
- Normal maintenance as outlined in this manual.
- Malfunction resulting from improper maintenance not in accordance with the steps contained in this manual and any applicable training.
- Damage caused by abuse or careless handling outside of the normal operating procedures contained in this manual.
- Damage from moisture into electrical components.
- Damage from tampering with or removal of any safety device.

### **IMPORTANT!**

**Keep these instructions for future reference. If the unit changes ownership, be sure this manual accompanies the equipment.**

### **IMPORTANT**

**The Nieco Corporation reserves the right to change specifications and product design in accordance with the general terms and conditions outlined in the BURGER KING®/Vendor agreement. Such revisions do not entitle the buyer to corresponding changes, improvements, additions or replacements for previously purchased equipment.**

### A.3 Service/Technical Assistance

If you experience any problems with the installation or operation of your broiler, contact your local Authorized Nieco Distributor.

Fill in the information bellow and have it handy when calling your authorized service agency for assistance. The serial number is on the broiler rating plate on the back of the unit.

Purchased from: \_\_\_\_\_

Date of Purchase: \_\_\_\_\_

Model No.: \_\_\_\_\_

Serial No.: \_\_\_\_\_



For the name of your local Authorized Nieco Distributor, please call (800) 821-2141.



Use only genuine Nieco replacement parts in your broiler. Use of replacement parts other than those supplied by Authorized Nieco Distributors and Service Agencies will void the warranty and may significantly alter the performance of your broiler. The use of non-Nieco parts is capable of affecting these criteria, and may affect broiler performance, parts longevity and food safety. Your local Authorized Nieco Distributor and Service Agent has been factory trained and has a complete supply of parts for your Nieco Automatic Broiler.



You may contact the factory direct at +1-707-284-7100 if you have trouble locating your local Nieco Distributor.



### A.4 Important Safety Information

Throughout this manual, you will find the following safety words and symbols that signify important safety issues with regards to operating or maintaining the equipment:

 <b>WARNING</b> 
<b>GENERAL WARNING.</b> Indicates information important to the proper operation of the equipment. Failure to observe may result in damage to the equipment and/or severe bodily injury or death.

 <b>WARNING</b> 
<b>ELECTRICAL WARNING.</b> Indicates information relating to possible shock hazard. Failure to observe may result in damage to the equipment and/or severe bodily injury or death.

 <b>CAUTION</b> 
<b>GENERAL CAUTION.</b> Indicates information important to the proper operation of the equipment. Failure to observe may result in damage to the equipment.

 <b>WARNING</b> 
<b>HOT SURFACE WARNING.</b> Indicates information important to the handling of equipment and parts. Failure to observe caution could result in personal injury.

## A.4 Important Safety Information (Continued.)

In addition to the warnings and cautions in this manual, use the following guidelines for safe operation of your Nieco Automatic Broiler:

- Read and follow all instructions before using this equipment.
- Install or locate broiler only for its intended use as described in this manual.
- Do not operate this equipment if it has a damaged cord or plug, if it is not working properly or if it has been otherwise damaged.
- This equipment should only be serviced by authorized personnel. Contact your local Nieco Distributor for adjustment or repair.
- Use only genuine Nieco replacement parts for your broiler. Failure to do so will void the warranty and may significantly alter the performance of your broiler. The use of non-Nieco parts is capable of affecting these criteria, and may affect broiler performance, parts longevity and food safety.

**The following warnings and cautions appear throughout the manual and should be carefully observed:**

- **Turn the broiler off, close the main gas valve, and disconnect the plug before performing any service, maintenance or cleaning on the broiler.**
- **Always allow the broiler to fully cool before performing any service, maintenance or cleaning. Failure to wait for the broiler to cool fully may result in personal injury.**
- **The procedures in this manual may include reference to the use of chemical products. The Nieco Corporation does not endorse the use of any particular cleaning/degreasing agent. Use only those chemicals that are approved for use in your kitchen.**
- **The broiler should be grounded according to local electrical codes to prevent the possibility of electrical shock. It requires a grounded receptacle with separate electrical lines, protected by fuses or circuit breakers of the proper rating.**
- **All electrical connections must be in accordance with local electrical codes and any other applicable codes.**
- **The use of adequate ventilation (as rated in this manual) with this broiler is mandatory. Failure to adequately ventilate this unit and provide safe operating distances (as specified in this manual) is a fire safety hazard. Follow the instructions for emergency broiler shutdown in the event of an emergency.**
- **No attempt should be made to operate this appliance in the event of a power failure.**

**WARNING ELECTRICAL SHOCK HAZARD. FAILURE TO FOLLOW THESE INSTRUCTIONS COULD RESULT IN SERIOUS INJURY OR DEATH:**

- **Electrical ground is required on this appliance.**
- **Check with a qualified electrician if you are in doubt as to whether the appliance is properly grounded.**
- **Do not use water on or near the control box for risk of serious injury or death due to electrical shock.**

**WARNING, HIGH TEMPERATURES WITH HOT SURFACES. FAILURE TO FOLLOW THESE PROCEDURES COULD RESULT IN SERIOUS INJURY:**

- **Do not attempt to clean, disassemble or perform maintenance on this broiler until it is fully cooled as per the instructions contained in this manual.**

# B. INSTALLATION

## B.1 Pre-Installation

Uncrate the broiler and inspect for shipping damage. Remove the tape securing the machine parts, and install the parts in their proper location. If there are obvious or concealed damages to any part of the broiler, please contact your freight carrier. The factory warranty does not cover freight damage.

## B.2 Mounting

Follow the mounting instructions if this function is not performed by the installer.

## B.3 Leveling

The grease drain system is based on a gravity-flow design. Therefore, it is extremely important that the broiler be placed on a level surface.

## B.4 Hood Requirements

This appliance must be installed under a ventilation hood of adequate size. Do not obstruct the flow of combustion and ventilation air. An adequate air supply must be available for safe and proper operation.

For installations in the Commonwealth of Massachusetts the following shall apply: Venting shall be in compliance with NFPA Section 10.3.5.2 for the Model JF93.

## B.5 Clearance

Keep appliance area free from combustibles.

To facilitate disassembly and service of the unit a minimum of 24" (610 mm) should be allowed on the control panel (feed end) of the broiler.

### REQUIRED AND RECOMMENDED CLEARANCES

	<b>REQUIRED</b> for installation near combustible walls and construction	<b>REQUIRED</b> for installation near non-combustible walls and construction	<b>RECOMMENDED</b> by Nieco for proper disassembly and service
Back of broiler	12" (305 mm)	0" (0 mm)	0" (0 mm)
Sides of broiler	12" (305 mm)	0" (0 mm)	0" (0 mm)
Front of broiler (Feed end)	12" (305 mm)	0" (0 mm)	24" (610 mm)



## B.6 Gas Connection- 3/4" N.P.T.

At rated input the gas supply should deliver a minimum pressure of at least 15 mbar (6" water column) at the broiler connection for natural gas. Incoming gas supply pressure must not exceed 50 mbar (14" water column).

**Note:** The installation of this appliance must conform with local codes, or in the absence of local codes, with the National Fuel Gas Code, ANSI Z223.1, Natural Gas Installation Code, CAN/CGA-B149.1 including:

1. The appliance and its individual shutoff valve must be disconnected from the gas supply piping system during any pressure testing of that system at test pressures in excess of 1/2 psi (3.45 kPa).
2. The appliance must be isolated from the gas supply piping system by closing its individual manual shutoff valve during any pressure testing of the gas supply piping system at test pressures equal to or less than 1/2 psi (3.45 kPa).

By public initiative, the State of California has adopted legislation (Proposition 65) which requires manufacturers of many types of products, including gas appliances, to warn consumers of their products that contain chemicals or produce substances listed by the State of California to either cause cancer, birth defects or other reproductive harm.

	<b>WARNING</b>	
<b>If not installed, operated and maintained in accordance with the manufacturers instructions, this product could expose you to substances in fuel or from fuel combustion which can cause cancer, birth defects or other reproductive harm.</b>		

## B.7 Installing Gas Appliance Connectors and Flexible Gas Lines Correctly

For safety in the kitchen area, and to insure maximum service life, it is vitally important to correctly install connectors. The connector shall comply with the Standard for Connectors for Moveable Gas Appliances, ANSI Z21.69 or CAN/CGA-6.16 and a quick disconnect device that complies with the Standard for Quick-Disconnect Devices for use with gas fuel, ANSI Z21.41 or CAN1-6.9

In order to avoid sharp kinks or excessive bends that could have a damaging effect on the connector, it may be necessary to attach pipe elbows in order to bring the connector into its proper plane. For easy movement of the appliance, the connector should be installed with a "lazy" loop for minimum tension.

**Note: Gas appliances should be disconnected prior to maximum movement. (Minimal movement is possible to connect hose.)**

## B.8 Restraining Device Installation and Use

This high strength restrainer is to be used with all moveable (castered) appliances. It fully complies with American Gas Association requirements. References: Z21.69, Z83.11, and Z21.41 with current revisions. Installation is quick and positive. In Canada, device is in accordance with CAN 1-6.9-M70 Quick Disconnect Devices for use with gas fuel, and CAN 1-6.10-88 metal connectors for gas appliances. Correct length for any appliance is simply a matter of loosening two adjuster clips (1) and re-tightening. (3" to 6" shorter than appliance connector is desired length.) Restrainer is made of heavy duty steel cable, with a strong scissor hood (2) at one end, and an equally strong spring hook (3) at the other. Cotter pin (4) is supplied to secure the installation. For proper attachment to the broiler, use the supplied hardware to attach the device to the holes in the shear plate of the broiler stand.

**NOTE: If disconnection of the restraint is necessary, reconnect the restraint after the appliance has been returned to its originally installed position.**

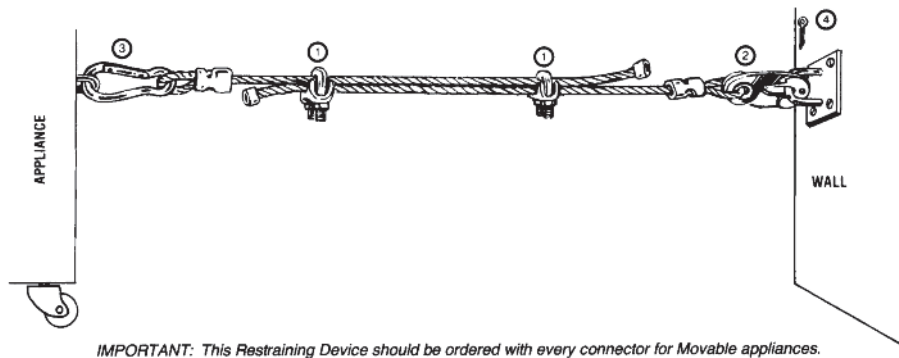

## B.9 Electrical Connection

Power requirements are stated on the unit nameplate and must be connected accordingly. This appliance, when installed must be electrically grounded in accordance with local codes, or in the absence of local codes, with the National Electrical Code, ANSI/NFPA 70, or the Canadian Electrical Code, CSA C22.2, as applicable. Before starting broiler, tighten all electrical connections in control box. An electrical wiring diagram can be found inside the control box.

**Note:** Disconnect power before servicing.

## B.10 Pre-Operation Check

Be sure that all parts are installed in the proper location:

- Ventilation is turned on
- Broiler is plugged in
- Gas line is connected



## C. OPERATION

### C.1 Controls and Indicators

1. Belt Speed Control (P/N 13727-B) - Used to set the broil time on the meat belt.
2. Temperature Control (P/N 19076) - Helps keep the broiler temperature stable when the broiler is under heavy load.
3. Main on/off switch. Used to turn the power on or off to the broiler.
4. Power indicator light. Glows green when the power to the broiler is turned on.
5. Ignition failure light. This light will flash if the broiler burners fail to ignite. Cycle the on/off switch to reset. Check the troubleshooting guide if the broiler fails to light.

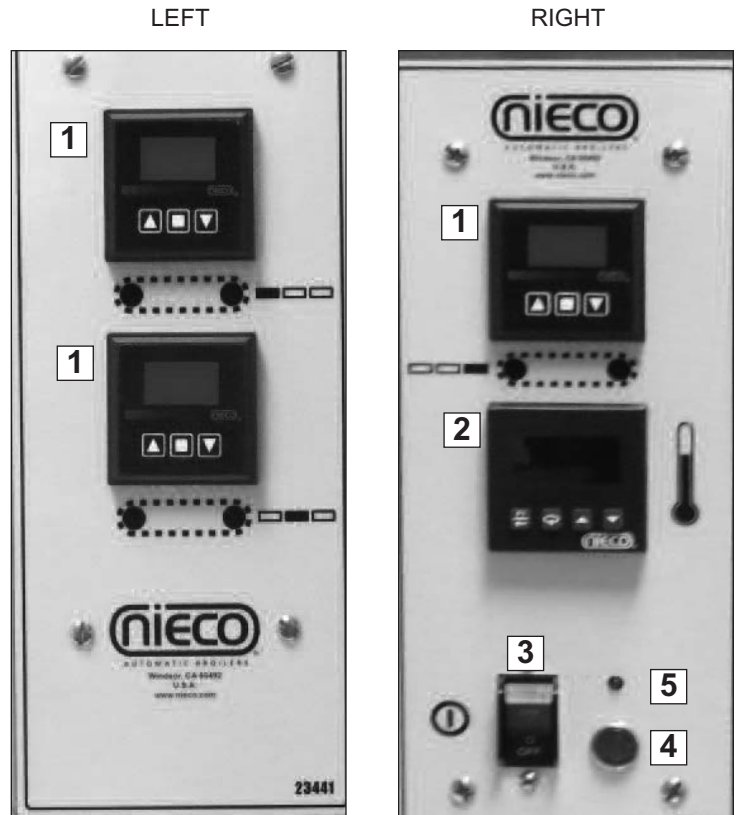

### ON THE BACK OF THE BROILER

1. Belt reverse buttons. Pres and hold these buttons to reverse the direction of the belt to help free a belt jam.
2. Shaft cleaning tool. Use this tool on the drive and idler shafts to scrape them clean.

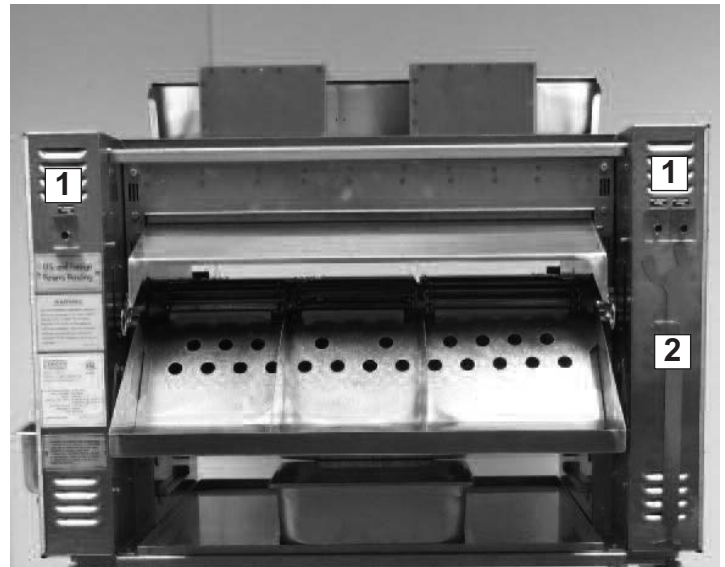

## C.2 Lighting Procedures

### PRE-LIGHTING PREPARATION

1. Broiler is centered under hood and plugged in
2. Gas valve is open when handle is in line (parallel to) the pipe
3. Turn ventilation system on

#### **WARNING**

**THE VENTILATION SYSTEM MUST BE ON AT ALL TIMES DURING BROILER OPERATION. OPERATING BROILER WITHOUT PROPER VENTILATION IS A SEVERE FIRE**

### NORMAL IGNITION

The JF64-3G is equipped with automatic ignition. When the broiler is turned on, a hot surface ignitor turns on 5 seconds before the flow of gas. Gas then flows to all of the burners. If the burners are not lit within 10 seconds, the control will reset and try again for 10 seconds. This occurs 3 times. If the broiler does not light after the third attempt, the ignition failure light will flash and the main on/off switch must be cycled to repeat the procedure. If this still doesn't light the broiler, see the MANUAL IGNITION instructions.

1. Turn the **MAIN POWER SWITCH** on.



2. Allow broiler to heat for 45 minutes before cooking.



## C.2 Lighting Procedures (Continued.)

### MANUAL IGNITION

1. Remove the return awning. Turn the **MAIN POWER SWITCH** on. Hold a lighter/match to the upper burner on the discharge end until the burner lights. Once the first burner is lit, verify that all burners have ignited.

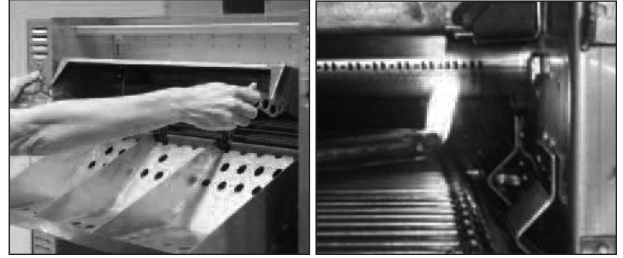

## C.3 Shutdown Procedures

### PLANNED SHUTDOWN

1. Allow the broiler to run free of any product for 10 minutes. This will burn the chain clean.

2. Close the main gas valve and allow the broiler to run without gas for 10 minutes.

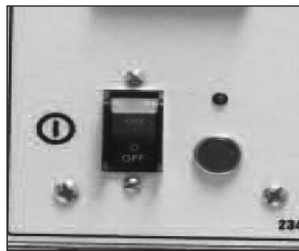

3. Turn off the **Main Power Switch**.

4. Wait for the broiler to cool.

### EMERGENCY SHUTDOWN

1. Turn off the **MAIN POWER SWITCH**.

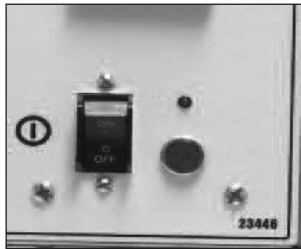

2. Close the **MAIN GAS VALVE**

Valve is closed when it is perpendicular to pipe.



Your Nieco Automatic Broiler is designed to automatically stop gas flow to the broiler in the event of power failure, gas pressure loss or any other related incident. No attempt to operate this appliance should be made in the event of a power failure.

#### ⚠ CAUTION ⚠

In a prominent location, post instructions to be followed in the event the user smells gas. This information shall be obtained by consulting your local gas supplier.

#### ⚠ CAUTION ⚠

**FOR YOUR SAFETY:** Do not store or use gasoline or other flammable vapors or liquids in the vicinity of this or any other appliance.

#### ⚠ CAUTION ⚠

**FOR YOUR SAFETY:** In the event of a prolonged power failure, no attempt should be made to operate this appliance.

## C.4 Control Operation

### MAIN SIDE CONTROLS

#### 1. SETTING BELT SPEEDS

Press up arrow to increase broil time; press the down arrow to decrease broil time. After you have set the control the display will be flashing. Press the center square to save your changes. NOTE: After making changes to the broil time, if you do not press the center square button, your changes will not be saved.

Use the up and down arrows to set the time. Press the center square button to save your changes.

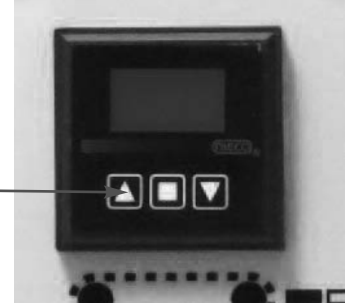

#### 2. TEMPERATURE CONTROL

Gas broilers are equipped with a Broil Temperature Stabilizer Control that senses when the broiler is being used, and adjusts the temperature to keep the broiler hot during heavy use. The control consists of two parts - a temperature probe to sense the internal temperature of the broiler, and the control itself.

#### 3. CALIBRATING THE TEMPERATURE CONTROL

In order to assure proper operation, the Temperature Control must be set for operation in the restaurant. Follow these step by step instructions when the broiler is new, and once per month after.

Step 1: Be sure all pieces of the broiler are in place. Make sure the broiler is plugged in and the exhaust hood is turned on. Turn the broiler on.

Step 2: Flex side: Set the temperature (bottom number) to 1000° F (537° C). Use the up or down arrows on the control to set the temperature. Leave the broiler at 1000° F for one hour. DO NOT COOK DURING THIS HOUR. After the hour is up, use the arrows to put the set point to 20° UNDER the actual temperature. The bottom number is the set temperature and the top number is the actual temperature.



## D. CLEANING AND DISASSEMBLY

Turn broiler off and close the main gas valve. Disconnect the power supply to the broiler before cleaning or servicing. If this broiler is connected using a restraint, and disconnection of the restraint is necessary for cleaning or moving the broiler, the restraint must be reconnected after the broiler has been returned to its originally installed position. Allow to cool for 30 minutes prior to cleaning/disassembly. Leave the ventilation system on during cooling. Use only approved cleaning, degreasing and sanitizing solutions.

### ⚠ WARNING ⚠

LEAVE THE VENTILATION HOOD ON DURING COOLING. FAILURE TO DO SO COULD POSE A FIRE SAFETY HAZARD.

### ⚠ CAUTION ⚠

Follow the Disassembly and Reassembly steps to ensure proper operation of the broiler. Failure to do so may result in operational problems.

### ⚠ WARNING ⚠

BROILER PARTS ARE HOT. DO NOT ATTEMPT TO DISASSEMBLE THE BROILER UNTIL IT IS FULLY COOL. FAILURE TO FOLLOW THIS INSTRUCTION MAY RESULT IN SEVERE INJURY.

**ALL PARTS ARE CLEANED ON A DAILY BASIS UNLESS OTHERWISE NOTED**

Follow the steps for proper disassembly. Reverse the order for reassembly.

## How to read the cleaning section

The name of the part to be cleaned.

The location of the part.

When to clean the part.

	Meat Guides	Clean: Every 4 hours
The tools needed to clean the part	Tools 3 Compartment Sink Scrub Pad	Feed End
How to remove and clean the parts.	Instructions 1 Pull each meat guide out slightly from the bottom, then lift off. 2 Wash, rinse, and sanitize in the 3-compartment sink.	Picture of the part to be removed and cleaned.

## Cleaning the Broiler

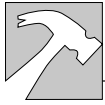

### Tools Needed



**STOP**

### Important Symbols



This “Stop” sign shows a step in the procedure that must be followed exactly or personal safety could be affected.



This warning symbol shows a step in the procedure that must be followed exactly or broiler performance could be affected.



This “puzzle” symbol shows a step in the reassembly procedure that must be followed.



### Instructions

1. Allow the broiler to run free of product for 10 minutes before turning it off. This allows any residue to burn off the chains.
2. Shut the broiler off and let it cool for 30 minutes before disassembly and cleaning.
3. Close the main gas valve and unplug the broiler before cleaning.
4. Always leave the ventilation hood on during the 30 minute cool down period.
5. Use only approved cleaning solutions.
6. Allow parts to air dry after cleaning.

## Front Heat Shield

**Clean: Daily**



### Tools



### Instructions

1. Lift the Front Heat Shield up and off the unit.
2. Wash, rinse, and sanitize in the 3-compartment sink.

### Feed End



## Grease Pan, Feed Extension

Clean: Daily



### Tools

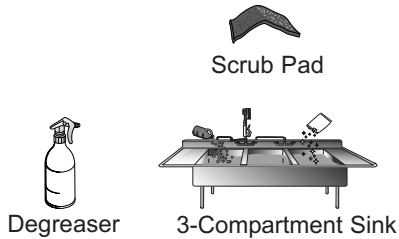

### Instructions

1. Slide grease pan out.

! Make sure grease pan is cool before putting in water or it may warp the pans.

2. Take to sink area and spray with degreaser.

3. Wash with a scrub pad, rinse, and sanitize in the 3-compartment sink.

### Feed End



## Grease Pan, Lower

Clean: Daily



### Tools

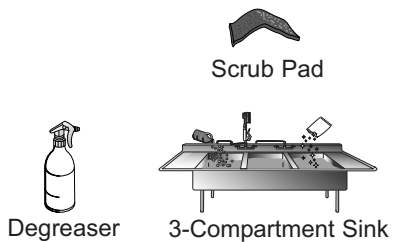

### Instructions

1. Slide lower pan out.

2. Take to sink area and spray with degreaser.

3. Wash with a scrub pad, rinse, and sanitize in the 3-compartment sink.

### Feed End



## Heat Shield

Clean: Daily



### Tools

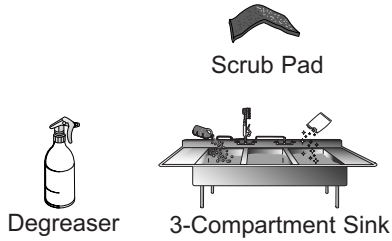

Scrub Pad

Degreaser

3-Compartment Sink



### Instructions

1. Slide Shield out.
2. Take to sink area and spray with degreaser.
3. Wash with a scrub pad, rinse, and sanitize in the 3-compartment sink.

### Feed End



## Grease Drip Tray

Clean: Daily



### Tools

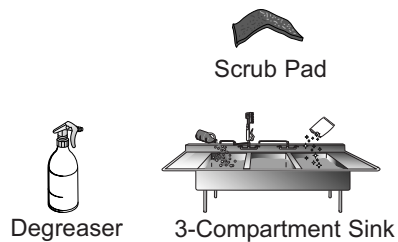

Scrub Pad

Degreaser

3-Compartment Sink



### Instructions

1. Slide Drip Tray out.
2. Take to sink area and spray with degreaser.
3. Wash with a scrub pad, rinse, and sanitize in the 3-compartment sink.

### Feed End





## Product Holding Area

Clean: Daily



### Tools



Soapy Towel



Sanitized Towel



### Instructions

1. Clean product holding area while still warm.
2. Wring out a soapy towel and wash product holding area.
3. Wring out a sanitized towel and wipe product holding area.

### Feed End



## Discharge Awning

Clean: Daily



### Tools



Scrub Pad



Degreaser

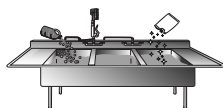

3-Compartment Sink



### Instructions

1. Lift up and off.
2. Take to sink area and spray with degreaser.
3. Wash, rinse, and sanitize in the 3-compartment sink.

### Discharge End

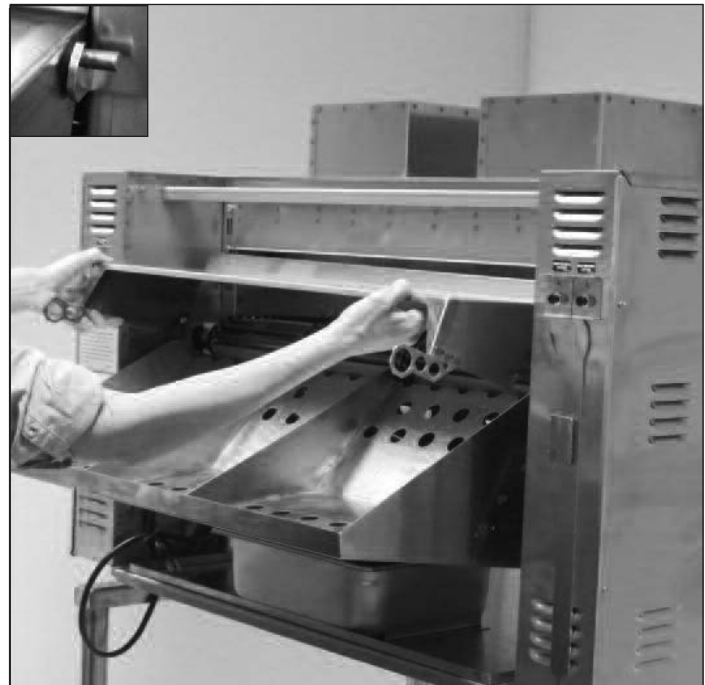

# Patty Catch Pan and Insert

Clean: Daily



## Tools

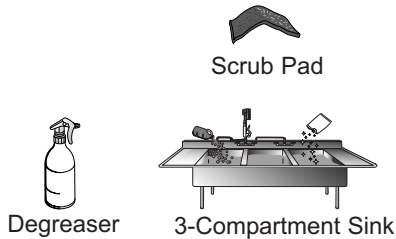

## Instructions

1. Lift Insert out of Catch Pan then Remove Pan.
2. Take to sink area and spray with degreaser.
3. Wash, rinse, and sanitize in the 3-compartment sink.

REASSEMBLY: Make sure pan inserts are on and return pan hangs on brackets.

## Discharge End



# Stripper Blade

Clean: Daily



## Tools



## Instructions

1. Tilt stripper blade away from chain; lift off brackets.

Make sure stripper blade is cool before putting in water or it may warp.

2. Take to sink area and spray with degreaser.
3. Wash with a scrub pad, rinse, and sanitize in the 3-compartment sink.

REASSEMBLY: Hang stripper blade on brackets.

## Discharge End



## Side Grease Box

Clean: Daily



### Tools



Degreaser



Scrub Pad

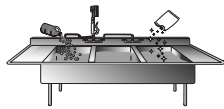

3-Compartment Sink



### Instructions

1. Remove the grease box.
2. Take to sink area and spray with degreaser.
3. Wash with a scrub pad, rinse, and sanitize in the 3-compartment sink.

### Side



## Grease Trough

Clean: Daily

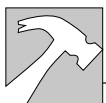

### Tools



Degreaser



Scrub Pad

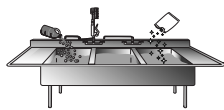

3-Compartment Sink



### Instructions

1. Lift and slide the grease trough out of the broiler.
2. Take to sink area and spray with degreaser.
3. Wash with a scrub pad, rinse, and sanitize in the 3-compartment sink.

 **REASSEMBLY:** Be sure grease trough is pushed all the way into the broiler.

### Side



## Lower Burner

Clean: Daily



### Tools

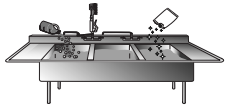

3-Compartment Sink



Scrub Pad



### Instructions

1. Lift the burner latch.
2. Slide burner out.
3. Take to the 3-compartment sink and scrub with a scrub pad or nylon brush.
4. **If necessary, use a stiff toothbrush to clean any clogged burner holes.**



**REASSEMBLY:** Be sure the holes on the burner are facing up.



⚠ Burner must be completely dry before reassembly. Dry with a paper towel.

### Side



## Incendalyst™

Clean: Weekly



### Tools



Heat Resistant Gloves



### Instructions



**EXTREMELY HOT!** Be careful not to burn yourself.

1. Grasp handle and lift Incendalyst™ off to remove from chimney.
2. **SOAK IN WARM WATER FOR 1 HOUR. RINSE WITH WATER ONLY. NEVER USE ANY CHEMICALS ON THE CATALYST.**
3. Lay flat to drain water and let air dry overnight.
4. Make sure Incendalyst™ is dry before putting back on broiler.

### Top



CAUTION: Extremely Hot



# Incendalyst™ Chimney

Clean: Weekly



## Tools



Heat Resistant Gloves



Scrub Pad



Degreaser

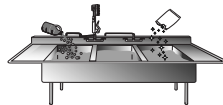

3-Compartment Sink



## Instructions



**EXTREMELY HOT!** Be careful not to burn yourself.

1. Lift Incendalyst™ chimney up and off.
2. Take to sink area and spray with degreaser.
3. Wash with a scrub pad, rinse, and sanitize in the 3-compartment sink.

## Top



CAUTION: Extremely Hot



# Upper Heat Shield

Clean: Monthly



## Tools



Heat Resistant Gloves



Scrub Pad



Degreaser

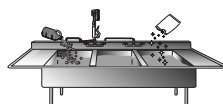

3-Compartment Sink



## Instructions



**EXTREMELY HOT!** Be careful not to burn yourself.

1. Lift upper heat shield up and off.
2. Take to sink area and spray with degreaser.
3. Wash with a scrub pad, rinse, and sanitize in the 3-compartment sink.

## Top



CAUTION: Extremely Hot



## Pilot Orifices

Clean: Monthly



### Tools



Flat Head  
Screwdriver



### Instructions

1. Use a flat head screwdriver or box cutter to clean the slots on the pilot orifices.

### Interior



## Flame Sensor

Clean: Monthly



### Tools



Scrub Pad



### Instructions

1. Remove the left side control box cover.
2. Remove the ceramic boot from the back of the flame sensor.
3. Loosen the wing nut holding the flame sensor in place.
4. Remove the flame sensor and clean the metal tip with a DRY, clean scrub pad.

### Side



## Upper Burner/Air Boxes

Clean: Monthly



### Tools



Heat Resistant Gloves

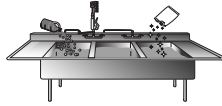

3-Compartment Sink



Scrub Pad



### Instructions

1. Lift air upper burner and air box from the top of the broiler. It is not necessary to detach them.
2. Use a stiff brush to clean any clogged burner holes.



Be sure that both air box assemblies are installed and sit flush on their brackets.

### Top



## Main Burner Orifices

Clean: Monthly



### Tools



Small  
Orifice  
Brush



### Instructions

1. Use a small brush to clean the main burner orifices

### Side



## Chain Shafts

Clean: Daily



### Tools



Shaft Cleaning Tool



### Instructions

1. Scrape shaft of each belt on the discharge end with the wide end of the shaft cleaning tool. The tool is located on the clip on the discharge end of the broiler.
2. Wipe shaft cleaning tool with a towel.

### Discharge End



## INNER HEAT SHIELDS

Clean: Daily



### Tools



Shaft Cleaning Tool



### Instructions

1. Reach between the belt with the Shaft Cleaning Tool to scrape deposits from the inner shield.



## BELT ADJUSTMENT

As Needed



### Tools



### Instructions

1. Remove Discharge Awning and stripper blade.
2. Loosen slotted crossbar bracket.
3. Pry on shaft to adjust belt.
4. Tighten bolts.





## E. TROUBLESHOOTING

**Always verify that the broiler is properly assembled, the hood is on, gas valve open and broiler is plugged in.**

No power to broiler when the switch is turned on.	Check: Broiler is plugged in. Ventilation hood is on. Circuit Breaker on wall panel is on.
Broiler has power, but the burners do not light.	Check: Ventilation hood is on. Gas line is properly plugged in. Manual gas valve (if equipped) is on. Burners are installed properly. Burners are clean and dry. Flame sensor wire connection. Follow manual lighting instructions.
Red light blinking on left control box.	Check the items above for burners not lighting. Turn power off and on again to reset ignition. Follow manual lighting instructions.
Hot surface ignitor does not heat.	Check for loose wires connecting the hot surface ignitor. Follow manual lighting instructions.
Power is on, broiler is lit, but the conveyor belts are not turning.	Check for a jam in the conveyor belt. Check the stripper blade and the flame arrestors to make sure they are installed properly.
Burgers sticking to slide or stripper blade.	Clean the slide and stripper blade very thoroughly. Check cookout temperature (undercooking).
<b>COOKING PROBLEMS</b> Burgers under or over cooked.	Adjust conveyor belt speed. Clean burners and orifices.
Excessive flaming in broiler.	Clean the catalyst if equipped. Check the hood for proper operation. Check product for overcooking.

# F. PARTS LOCATION DRAWINGS

Discharge End View

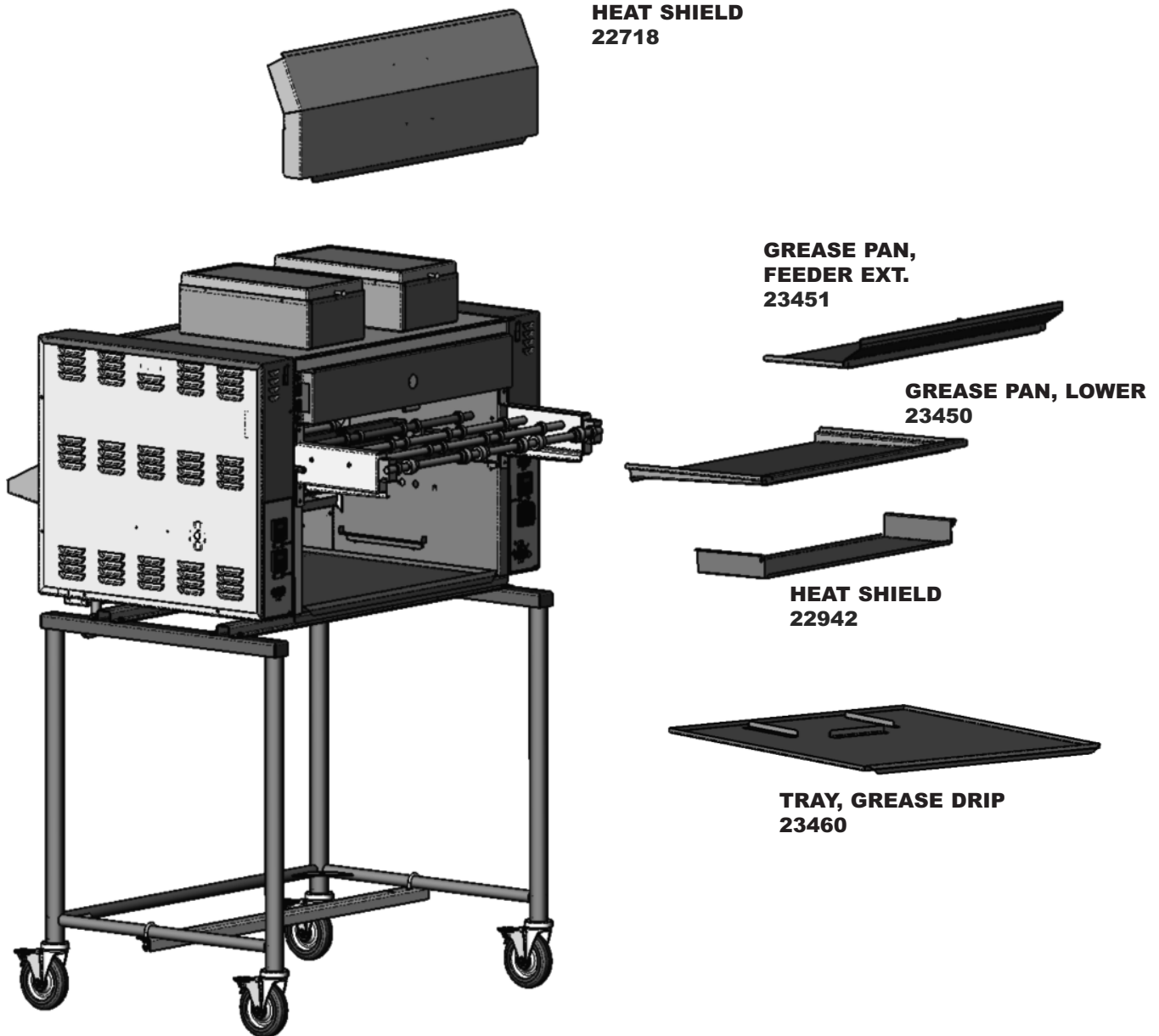

# F. PARTS LOCATION DRAWINGS

Feed End View

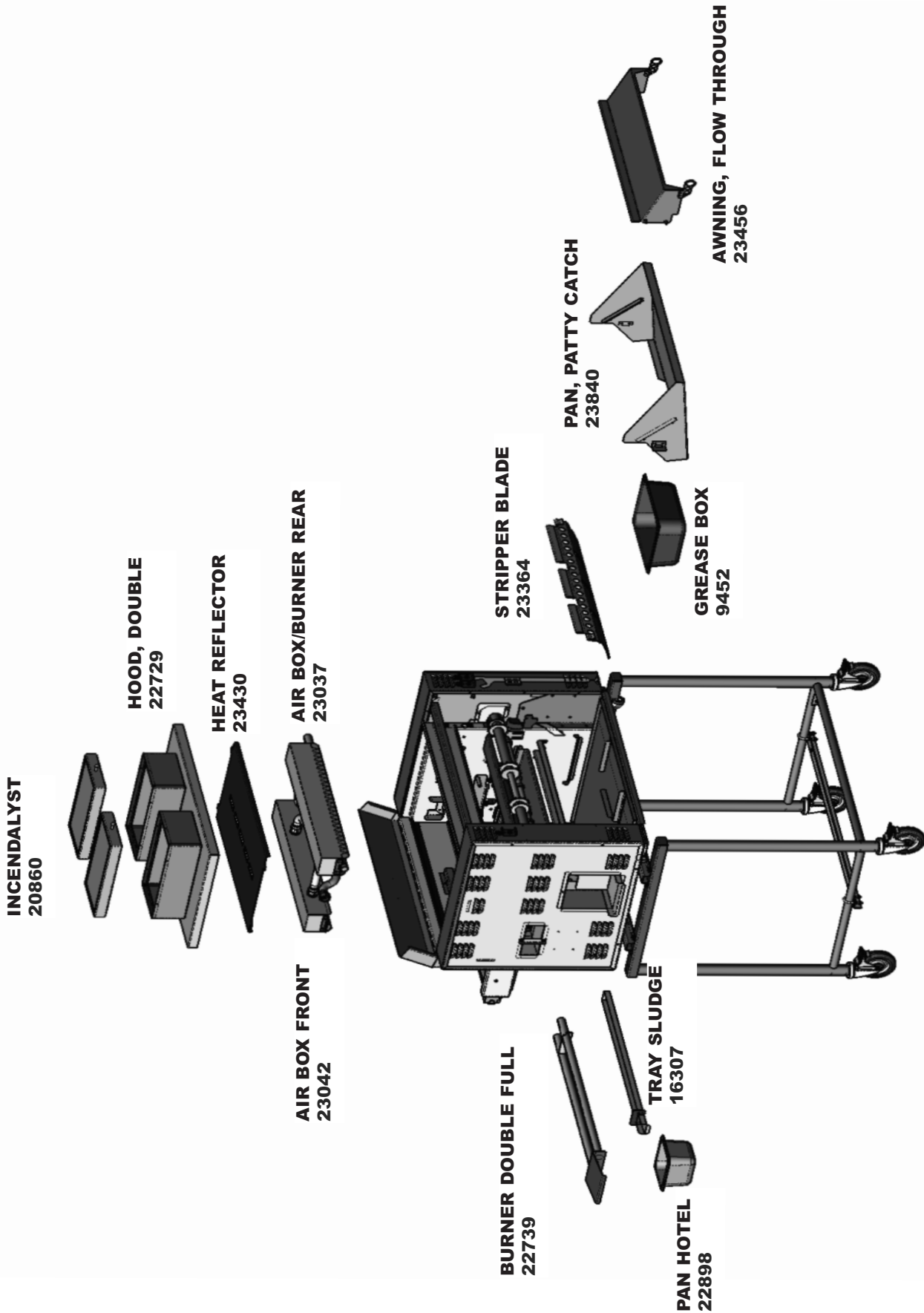

## G. PARTS REPLACEMENT LIST

<u>PART NO</u>	<u>DESCRIPTION</u>
<b><u>AIR BOX COMPONENTS</u></b>	
21214	CONNECTOR FLEX, 3/4 x 24"
23430	HEAT REFLECTOR, UPPER
23037	AIR BOX/BURNER, REAR
23042	AIR BOX/BURNER, FRONT
22739	BURNER, DOUBLE FULL,
19764	HEATER HOSE, 3/4 ID X 2"
18447	BLOWER, HIGH PRESSURE, 24VDC,
<b><u>GAS BURNER COMPONENTS</u></b>	
18152	ORIFICE, 1/8-27, FLAT TIP, #52 NAT
2182	ORIFICE, UPR. PILOT (3225) NAT
2047	ORIFICE, LWR. PILOT TOWN GAS(5232)
2070-40	ORIFICE, LWR. BURNER, #40 NAT
22930	ZIP TUBE PILOT ORIFICE #70 NAT
20826	ZIP TUBE, 8.44" LONG, JF - WLDMT
18159	ORIFICE, 1/8-27, FLAT TIP, #59 LP
17276	ORIFICE, PILOT, UPPER (4214) LP
23481	ORIFICE, ZIP TUBE, #78 LP
2066	ORIFICE, LWR. BURNER, #53 LP
2049-A1	SPRING, RV48, 5 - 12", LP
17276	ORIFICE, PILOT, UPPER (4214) LP
2179	PILOT BURNER (LOWER)
2180	PILOT BURNER (UPPER)
17185	SENSOR, FLAME, SLOTTED
18861	THERMOCOUPLE PROBE 1.88 TYPE J
10291	IGNITOR HOT SURFACE, 24V
2049-A	REGULATOR 3/4
12741	SOLENOID VALVE 24 VAC, 1/4 COMP. FIT
19054	SOLENOID VALVE, 1/2 NPT, 24 VAC
21316	VALVE MODULATING, 24V,1/2

## G. PARTS REPLACEMENT LIST

<b><u>BELT DRIVE SYSTEM &amp; BEARINGS</u></b>	
6027	#35 DRIVE CHAIN
6048	MASTER LINK Assy
6046	TEFLON BEARING, DRIVE SHAFT
6049	TEFLON BEARING, IDLER
20786	GEAR MOTOR, DC, BRUSHLESS
17899	SPROCKET, DRIVE MOTOR
11081	IDLER SPROCKET
<b><u>ELECTRICAL ELEMENTS</u></b>	
19076	CONROL,MODULATING VALVE,24V
16921	CONTROL, IGNITION, 24V
17201	LIGHT, IGNITION LOCK-OUT, LED
4402	GREEN INDICATOR LIGHT
13727-B	MOTOR CONTROL
17173	RAIL, POWER CONNECTION, 1 $\phi$ , 10MM
13579	SWITCH, MOTOR REVERSING
22929	TRANSFORMER, 100-115-230VAC x 18VAC
16034	CONTROL TRANSFORMER
15480	MAIN ON/OFF SWITCH
12725	BRIDGE RECTIFIER
<b><u>SHEET METAL PARTS</u></b>	
22729	HOOD, DOUBLE INCENDALYST
23450	GREASE PAN, 28.5" WIDE LOWER
23451	GREASE PAN, 28.5" FEEDER EXTENSION
22942	HEAT SHIELD, HOLDING PAN,
16307	TRAY, SLUDGE, GREASE
23460	TRAY, GREASE DRIP
9452	GREASE BOX 12"X10"X4"
22718	HEAT SHIELD, FRONT
22898	GREASE BOX SIDE
23364	STRIPPER BLADE
23840	PAN, PATTY CATCH
23456	AWNING, FLOW THROUGH

## G. PARTS REPLACEMENT LIST

<b><u>MISCELLANEOUS</u></b>	
20860	INCENDALYST, 15.19" X 8" X 1.5", 29 CPI
20058	PERF TOP
23307	CLEANING BRUSH, JF
23265	TOOL, COMBO CLEANING
23433	SHIM, LEVELING, 12 GA, BROILER STAND
<b><u>SPARE PARTS KIT</u></b>	
20786	GEAR MOTOR, DC, BRUSHLESS,
22929	TRANSFORMER, 100-115-230VAC x 18VAC
16034	CONTROL TRANSFORMER
19076	CONROL,MODULATING VALVE,24V
10291	IGNITOR HOT SURFACE, 24V
12725	BRIDGE RECTIFIER
17185	SENSOR, FLAME, SLOTTED
16921	CONTROL, IGNITION, 24V
18861	THERMOCOUPLE PROBE 1.88 TYPE J 48
13727-B	MOTOR CONTROL
18447	BLOWER, HIGH PRESSURE, 24VDC, 2

# H. WIRING DIAGRAMS

## 115V Wiring

REV.	DESCRIPTION	DATE	BY
A	Initial Release	4-Sep-12	KK
B	Add trace wires	17-Jul-13	KK

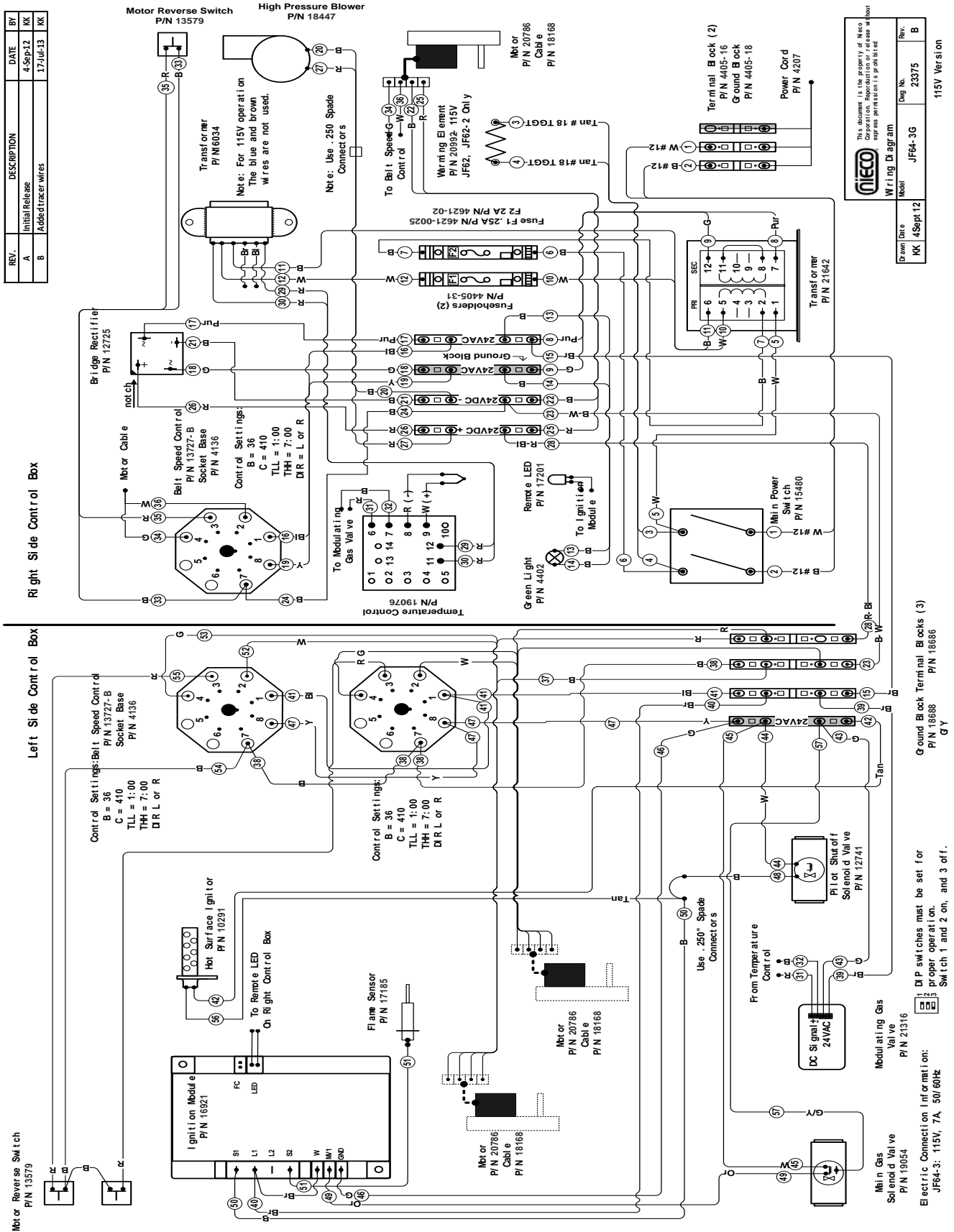

Drawn Date	Model	Drawn No.	Rev.
KK 4Sept12	JF64-3G	23375	B

Wiring Diagram  
 This document is the property of NiCO Corporation. Reproduction or release without express permission is prohibited.

115V Version



# I. SPECIFICATIONS

## AUTOMATIC BROILER

Model JF64-3G

DIMENSIONS	INCH	MM
Length	47.89	1216
Height	30.25	769
Width	40.23	1022

## ENERGY

Gas connection 3/4" N.P.T.

Electrical connection (specify exact voltage)

115V 10.5A or 220V 5.5A

Natural/LP Gas Operating Usage

Average usage::

BTU/hr 66,000

WEIGHT	LBS	KG
Broiler	350	158

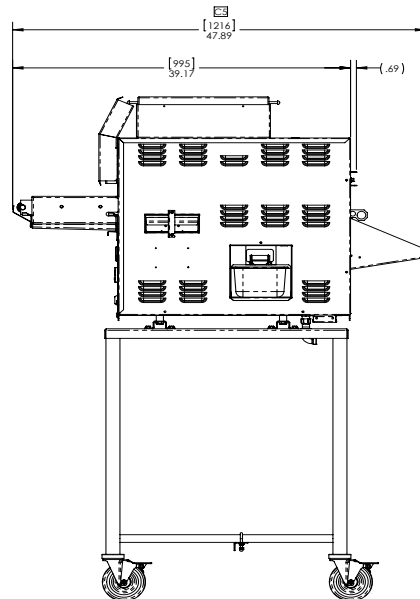
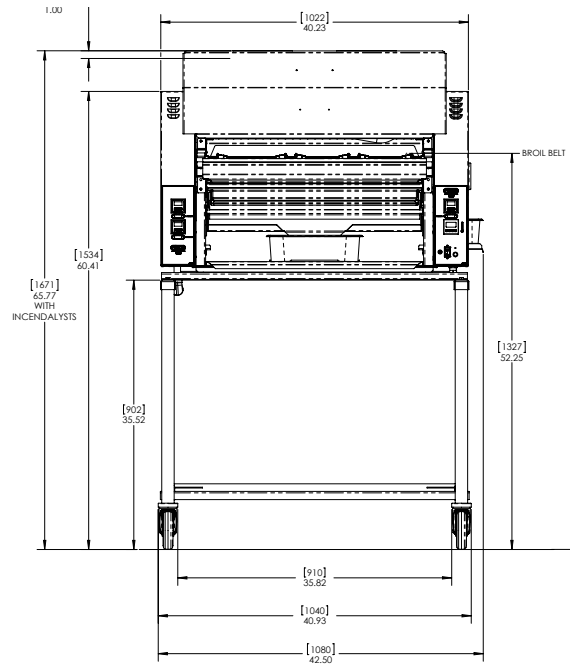

### ⚠ CAUTION ⚠

All electrical connections must be in accordance with local electrical codes and any other applicable codes.

### ⚠ CAUTION ⚠

Do not operate the broiler at gas pressures other than those stated here. Doing so will affect the operation of your broiler.

## Revision History:

Date	Notes	REV
11-25-13	Released	A



## Nieco Corporation

7950 Cameron Drive

Windsor, CA 95492

(707) 284-7100 Office • (707) 284-7430 Fax

www.nieco.com • e-mail: service@nieco.com

Printed in the USA © 2012 Nieco Corporation

All Rights Reserved P/N 99002

