

Pitco Frialator[®]

There's Always Something Cooking!

Installation, Operation, and Maintenance Manual
For Gas Pasta Cookers with Options

Covering Models
PPG14D, PG14D, and RS14D

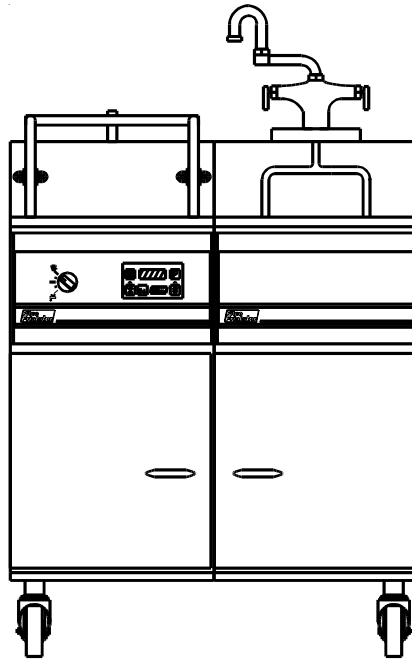

NOTICES

There are three different types of notices that you should be familiar with, a NOTICE, CAUTION, and WARNING. A NOTICE is a special note used to call attention to a particularly important point. CAUTION is used to point out a procedure or operation which may cause equipment damage. The WARNING notice is the most important of the three because it warns of an operation that may cause personal injury. Please familiarize yourself with your new cooker before operating it and heed the notices throughout this manual. The WARNINGS are listed below and on the following page for your review prior to operating the unit.

FOR YOUR SAFETY

DO NOT store or use gasoline or other flammable vapors or liquids in the vicinity of this or any other appliance.

WARNING: Improper installation, adjustment, alteration, service or maintenance can cause property damage, injury or death. Read the installation, operating and maintenance instructions thoroughly before installing or servicing this equipment.

TO THE PURCHASER

POST IN A PROMINENT LOCATION INSTRUCTIONS TO BE FOLLOWED IN THE EVENT THAT AN OPERATOR SMELLS GAS. OBTAIN THIS INFORMATION FROM YOUR LOCAL GAS SUPPLIER.

THIS MANUAL MUST BE RETAINED FOR FUTURE REFERENCE

SAFETY

SAFETY

SAFETY

SAFETY

SAFETY

WARNING

The cooker must be electrically grounded in accordance with local codes. If local codes do not apply, follow the requirements of National Code ANSI/NFPA 70-1990.

WARNING

This cooker is equipped with a three prong safety plug. This safety plug protects operators from electrical shock in the event of an equipment malfunction. **DO NOT** remove the grounding (third) prong from this plug.

WARNING

DO NOT use an open flame to check for gas leaks!

WARNING

A cooker that is equipped with casters and a flexible power cord must be connected to the gas supply with a Quick-Disconnect device. This quick disconnect must comply with ANSI Z24.41-1989. A restraining cable must be installed to limit the movement of the cooker.

WARNING

There is an open gas flame inside the cooker. The unit may get hot enough to set nearby materials on fire. Keep the area around the cooker free from combustible materials.

WARNING

Ensure that the cooker can get enough air to keep the flame burning correctly. If the flame is starved for air it can give off dangerous carbon monoxide. Carbon Monoxide is a clear odorless gas that can cause suffocation and death.

WARNING

Be sure the burner tubes are **COMPLETELY** covered with water before lighting the pilot or main burners. If the tubes are exposed, the cooker may overheat, causing damage to the kettle, creating a fire hazard, and voiding the warranty.

SAFETY

SAFETY

SAFETY

SAFETY

SAFETY

SAFETY

SAFETY

SAFETY

SAFETY

SAFETY

WARNING

Carbon monoxide can build up if the flue is blocked. Blocking the flue will also cause the cooker to overheat. Ensure that minimum clearances specified in the installation instructions are maintained. **DO NOT** obstruct the flow of combustion/ventilation or air opening around the cooker. Adequate clearance around the cooker is necessary for servicing and proper burner operation. Ensure that you meet the minimum clearances specified in the installation instructions.

WARNING

The power supply must be disconnected before servicing or cleaning the appliance.

WARNING

For gas cookers, **DO NOT** supply the cooker with a gas that is not listed on the data plate. If you need to convert the cooker to another type of fuel, contact your dealer.

WARNING

For gas cookers, **WAIT** five (5) minutes before attempting to relight the pilot. This allows time for any gas remaining in the cooker to dissipate.

WARNING

DANGER - HIGH VOLTAGE PRESENT

NEVER remove fuses from the cooker until the cooker is unplugged from the facility power supply.

THIS MANUAL MUST BE RETAINED FOR FUTURE REFERENCE

SAFETY

SAFETY

SAFETY

SAFETY

SAFETY

Table of Contents

Section	Title	Page
	Safety Notice	
	Table of Contents	i
	List of Tables	iii
	List of Figures	iii
CHAPTER 1: GENERAL INFORMATION AND INSTALLATION		1-1
1.1	Inspecting Your New Cooker	1-1
1.2	Assembly and Leveling	1-2
1.2.1	Leg/Caster Installation and Adjustment	1-2
1.2.2	Heat Deflector Installation	1-3
1.2.3	Basket Lift Access	1-3
1.3	Installation	1-3
1.3.1	Installation Clearances	1-4
1.3.2	Plumbing Connections	1-4
<i>1.3.2.1</i>	<i>Water Inlet Connections</i>	<i>1-4</i>
<i>1.3.2.2</i>	<i>Drainage Connections</i>	<i>1-4</i>
1.3.3	Gas Connection	1-4
<i>1.3.3.1</i>	<i>Fuel Types</i>	<i>1-5</i>
<i>1.3.3.2</i>	<i>Fuel Supply Line Leak and Pressure Testing</i>	<i>1-5</i>
<i>1.3.3.3</i>	<i>Gas Line Connection</i>	<i>1-6</i>
1.3.4	Electrical Connection	1-6
1.3.5	Ventilation and Fire Fighting System	1-7
<i>1.3.5.1</i>	<i>Fire Fighting System</i>	<i>1-7</i>
<i>1.3.5.2</i>	<i>Ventilation</i>	<i>1-7</i>
1.3.6	Inspection	1-8
1.4	Initial Adjustments	1-9
1.4.1	Visual Checks	1-9
1.4.2	Filling the Pasta Cooker	1-9
1.4.3	Pilot Light System	1-9
<i>1.4.3.1</i>	<i>Pilot Flame Adjustment</i>	<i>1-10</i>
1.4.4	Main Burner System	1-12
<i>1.4.4.1</i>	<i>Gas Line Requirements</i>	<i>1-13</i>
<i>1.4.4.2</i>	<i>Main Burner Adjustment</i>	<i>1-13</i>
1.4.5	Initial Cleaning	1-15
1.5	High Temperature Limit Switch	1-16

Table of Contents

Section	Title	Page
CHAPTER 2: OPERATING INSTRUCTIONS		2-1
2.1	Filling the Cooker	2-1
2.2	Cooker Start-Up	2-1
2.2.2	Manual Controls	2-2
2.3	COOKING	2-3
2.3.1	Digital Controller	2-3
2.3.2	Manual Controls	2-3
2.4	Cooker Shutdown	2-4
2.5	Electric Power Failure	2-4
2.7	Weekly Cleaning	2-5
CHAPTER 3: OWNER MAINTENANCE AND ADJUSTMENTS		3-1
3.1	Thermostat Calibration - Manual Units ONLY	3-1
3.2	Checking and Replacing Fuses	3-1
3.3	Maintenance	3-2
3.3.1	Flue And Baffle Inspection	3-2
3.3.2	Basket Lift Lubrication	3-2
3.4	Operator Troubleshooting	3-3

List of Tables

Table	Title	Page
1-1	Ventilation and Fire Safety References	1-8

List of Figures

Figure	Title	Page
1-1	Pilot Burner Assembly Flame Adjustment	1-12
1-2	Unitrol Gas Valve	1-12
1-3	Main Burner Conditions	1-12
1-4	Gas Manifold with Burner	1-13
3-1	Digital Controller	3-1

CHAPTER 1: GENERAL INFORMATION AND INSTALLATION

Congratulations on the purchase of your new Pitco Frialator Pasta cooker. This cooker will provide many years of reliable service if the operation and maintenance procedures presented in this manual are followed. The Pitco Frialator Pasta cooker is a state of the art pasta cooking appliance. The cooking tank holds approximately 13 gallons (49.2 liters) of water. The cooker has two heating modes: BOIL and SIMMER. Each heating mode is selected by using one of two types of control systems (Solid State Digital or Manual Controls). The digital controller offers one button control for fully automatic cooking. The manual control option uses manual switches located on the front panel. The temperature of the water (in simmer) is monitored and maintained at approximately 190°F by an internal thermostat when using manual controls. The digital controller allows the simmer temperature to be set by the operator and is maintained by the solid state controller. Quick recovery time and even temperatures are assured on gas models by use of the 77,500 BTU main burner system. It is important that the operator refer to this manual for installation, operation, and maintenance of the cooker, and that the operator be familiar with the safety notices located throughout this manual.

The Pasta Perfect cooker consists of a cooking/warming section and a rinsing/holding section. The cooking/warming section consists of a stainless steel well, an automatic basket lift, an electronic controller or manual control system, and a drain and overflow. The rinsing/holding section consists of a stainless steel well, a swing-away hot and cold water faucet, and a drain and overflow.

1.1 Inspecting Your New Cooker

Every effort has been made to ensure that the Pasta cooker is delivered in perfect condition. Inspect the cooker for damage as it is unpacked. If something is damaged, DO NOT sign the bill of lading. Contact the shipper immediately. The shipper is only responsible for damage or loss up to 15 days after delivery. Check the packing list enclosed with the cooker to ensure that all parts to the cooker have been received. If parts are missing, contact the dealer from whom the cooker was purchased. As the cooker and its accessories are unpacked, be careful to keep the weight of the cooker evenly distributed. Enclosed in the shipping crate is a brush to be used in cleaning the cooker.

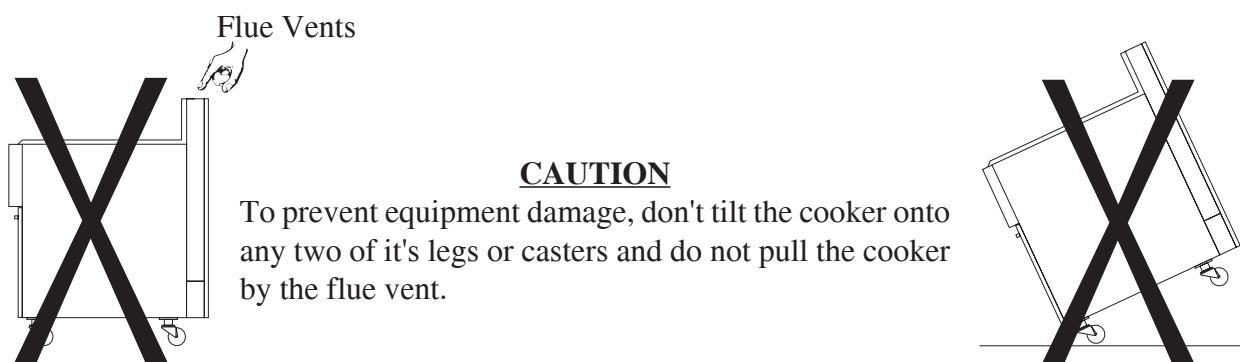

Locate the Pitco Frialator warranty and fill in the serial number of the cooker and the date received. The serial number is located on the identification plate inside the cooking and warming section door. Put the warranty card in a safe place for future reference. DO NOT return the card to Pitco Frialator. It is also very important to keep this manual for information should help be needed. The cooker has

been assembled at the factory and is ready to be installed. If the legs or casters were not installed or if they were purchased separately, refer to section 1.2 for leg and caster assembly procedures.

1.2 Assembly and Leveling

1.2.1 Leg/Caster Installation and Adjustment

Installing the legs and leveling the cooker is done using a 1/4" wrench and a large pair of water pump pliers. The legs must be installed before connecting the cooker to the gas supply. The legs provide the necessary height to meet sanitation requirements and assure adequate air supply to the burner. Attach the legs to the cooker by performing the following procedures:

- a. Place a blanket, piece of cardboard, or some other material on the floor behind the cooker.
- b. Place the cooker on its back. **DO NOT** pull on the flue vent. You can damage the flue by pulling on it.
- c. Attach each leg/caster to the cooker with four 1/4-20 x 5/8" hex head cap screws and lock washer/nut assemblies. These parts are supplied with the cooker.
- d. Mount the screws from the inside of the cooker with the lock washer and nut on the outside of the cooker as shown in the adjoining illustration.
- e. When all four legs/casters are secured, place the cooker in the upright position. Be careful not to put too much weight on individual legs/casters when standing the cooker upright.
- f. On fryers with casters, move the fryer to the desired location and lock the wheels using the locking devices on the top of the casters.
- g. Adjust the height and level the cooker by adjusting the leveling devices on the legs with water pump pliers.

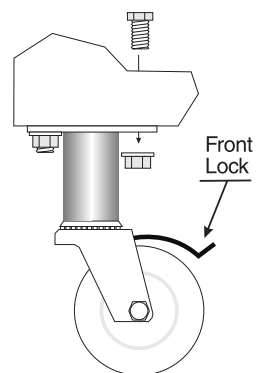
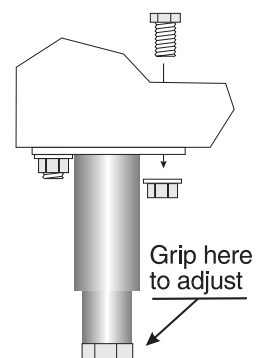

1.2.2 Heat Deflector Installation

If the Pasta cooker requires a heat deflector, a removable label will be located at the rear top edge of the cooker. This label has instructions for positioning and installing the heat deflector. Refer to the label and the following instructions to install the deflector:

- a. Remove the two self-drilling screws from the top, back area of the cooker.

WARNING

DO NOT obstruct combustion or ventilation openings around the cooker. Adequate clearance around the cooker is necessary for proper burner operation. Ensure that the minimum clearances specified in the installation instructions, paragraph 1.3.1, are followed.

- b. Position the heat deflector so that the angled portion of the deflector is facing toward the front of the cooker. Secure the heat deflector to the back of the cooker using the sheet metal screws removed in step a.
- c. When properly installed, the angled section of the heat deflector will extend over the flue opening to redirect the heat. It **SHOULD NOT** cover the flue opening. Blocking the flue opening will cause the cooker to overheat and produce dangerous Carbon Monoxide gas.

1.2.3 Basket Lift Access

The basket lift mechanism is installed at the factory and does not need adjustment. If it is necessary to gain access to the basket lift motors or linkage, the rear panel of the cooker must be removed. The motors do not require lubrication.

1.3 Installation

Although the cooker is easy to install and set up, it is **STRONGLY** recommended that this installation be done by qualified professionals. The professionals that install the new cooker will know the local building codes and ensure that the installation is safe.

NOTICE

Proper connection to electric, gas, water, and drainage services is essential for safe, efficient, and trouble free operation of the Pasta Perfect cooker.

1.3.1 Installation Clearances

The cooker needs clearance around it for proper operation. Adequate clearances allow for proper burner operation and servicing. The clearances shown below are for cooker installation in both combustible and noncombustible enclosures.

	<u>Combustible Construction</u>	<u>Non-Combustible Construction</u>
Back	6"	0"
Sides	6"	0"
Floor	6"	6"

1.3.2 Plumbing Connections

The plumbing installation must be done by a licensed plumber and must comply with local and national codes.

1.3.2.1 Water Inlet Connections

The water line connects to the cooker in the back of the unit. This line is connected to the manual fill valve (optional) or a faucet (optional).

NOTICE

If cold water only is used to fill the cooker, it will require at least thirty minutes to bring the water up to cooking temperature.

1.3.2.2 Drainage Connections

Both the cooking/warming section and the rinsing/holding section are equipped with drainage connections. The main drainage connection is located at the front bottom point of the cooker and is equipped with a 1-1/4" stainless steel and brass valve. The overflow drain is located underneath the front deck of the cooker. The overflow drain line is connected directly to the main drainage line.

1.3.3 Gas Connection

This information applies to the Pasta gas cooker only. The cooker will provide peak performance when the gas supply line is of sufficient size to provide the correct gas flow. The gas line must be installed to meet the local building codes and/or National Fuel Gas Code, NFPA 54-1984, and ANSI Z223.1-1988. In Canada, install the cooker in accordance with CAN-CGA 1-B149.1 and CAN-CGA 1-B149.2 and/or local codes. Gas line sizing requirements can be determined by your local gas company by referring to National Fuel Gas Code, Appendix C, Table C-4 (natural gas) and Table C-16 (propane). The gas line needs to be large enough to supply the necessary amount of fuel to reach all appliances without loss of pressure to any appliance. Other factors that are used to determine the piping requirements are BTU requirements of the appliances that are connected and the length of pipe between the gas meter and the appliances.

WARNING

DO NOT supply the cooker with a gas that is not indicated on the data plate. Using the incorrect gas type will cause improper operation. If you need to convert the cooker to another type of fuel, contact your dealer.

1.3.3.1 Fuel Types

Each Pasta cooker is equipped to work with one type of fuel. The type of fuel with which the appliance is intended to operate is stamped on the data plate attached to the inside of the cooking and warming section door.

WARNING

DO NOT use an open flame to check for gas leaks!

1.3.3.2 Fuel Supply Line Leak and Pressure Testing

The fuel supply system must be tested before the cooker is used. If the fuel line is going to be tested at a pressure greater than ($>$) 1/2 PSIG (3.45 kPa), make sure that the cooker is disconnected from the fuel line. If the fuel line is to be tested at a pressure equal to or less than (\leq) 1/2 PSIG (3.45 kPa), the cooker can be connected but the cooker's gas valve must be shut. Test all gas line connections for leaks with a solution of soap and water when pressure is applied.

NOTICE

NEVER use an adaptor to make a smaller gas supply line fit the cooker connection. This may not allow proper gas flow for optimum burner operation resulting in poor cooker performance. NEVER supply the cooker with any fuel other than the type indicated on the data plate. Using the wrong type gas will cause improper operation.

1.3.3.3 Gas Line Connection

Connect the cooker to the gas supply line with a connector that complies with the Standard for Connectors for Movable Gas Appliances, ANSI Z21.69/CAN-CGA-6.16.

If you are installing a cooker with casters, you must use a quick disconnect device that complies with Standard for Quick Disconnect Devices for Use with Gas Fuels, ANSI Z21.41-1989. In Canada refer to CAN 16.9 M79. The gas line connection should be similar to the gas line connection shown in the adjoining illustration.

A means of limiting the movement of a cooker with casters must be installed. The restraining device should be attached to the cooker on the back panel as shown in the illustration, thus preventing the gas line connector or the quick disconnect from being strained. The quick disconnect, hose, and restraining device can be obtained from your dealer.

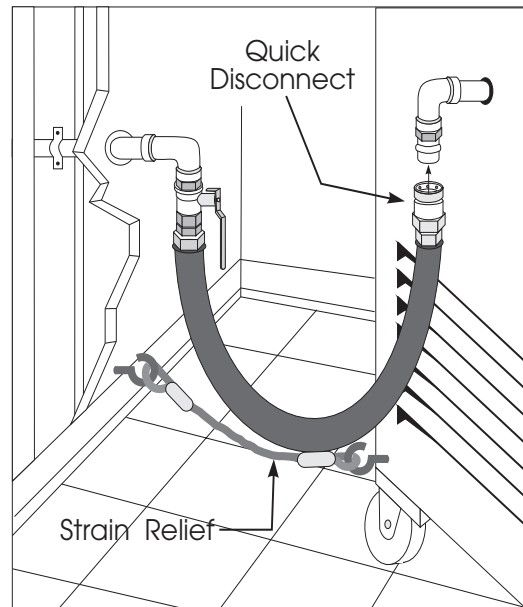

1.3.4 Electrical Connection

WARNING

The cooker must be electrically grounded in accordance with local codes. If local codes do not apply, follow the requirements of National Code ANSI/NFPA 70-1990.

The electrical service used by the cooker must comply with local codes. If there are no local codes that apply, refer to the National Electrical Code (NEC) to install the service. In Canada, refer to CSA Standard C22.1, Canadian Electrical Code, Parts 1 and 2, and/or local codes. Wiring diagrams are provided inside the cooker on the door. The power requirements for the cooker are shown on the next page.

The cooker is shipped with internal wiring configured to support the voltage and phase requirements ordered. The wiring configuration can be verified by comparing the schematic supplied with the cooker to the wiring arrangement in the cooker. Check the cooker data plate to ensure the cooker to be installed matches the power to be supplied to it.

The gas cooker is provided with one power cord which supplies power to the cooker controls and the basket lift. The cooker must be grounded in accordance with local code; if there is not a local code, comply with NEC ANSI/NFPA No. 70-1990. Be sure the cooker is correctly grounded. A non-insulated conductor may be used for the chassis to earth ground.

WARNING

The cooker is equipped with a three prong safety plug. This is to protect operators from electrical shock in the event of an equipment malfunction. DO NOT remove the grounding (third) prong from the plug.

Cookers shipped to Canada are not equipped with power supply cords.

Keep the POWER switch on the digital controller OFF until the cooker is ready for use.

1.3.5 Ventilation and Fire Fighting System

1.3.5.1 Fire Fighting System

Exhaust gas temperatures can reach as high as 1200°F. Therefore, it is very important to install an adequate fire fighting system. The sensing device that activates the fire fighting system should be located properly to reduce false alarms.

1.3.5.2 Ventilation

The Pasta cooker must have proper ventilation to function safely and properly and to prevent the formation of Carbon Monoxide gas. The ventilation system should be designed to allow for easy cleaning. Frequent cleaning of the ventilation system and the cooker will reduce the chances of fire. Table 1-2 provides a list of reference documents that provide guidance on ventilation and fire safety systems. This table may not be complete and other nationally recognized standards may apply. Additional information can be obtained from the American Gas Association, 8501 East Pleasant Valley Road, Cleveland, OH 44131.

In gas cookers, excessive ventilation causes drafts, which will interfere with the proper operation of the pilot and the main burner. Leave at least 18 inches of open space between the cooker's flue vent opening and the intake of the exhaust hood.

CAUTION

Ensure that the ventilation system does not cause a back draft (down draft) at the cooker's flue opening. Back drafts will not allow the cooker to exhaust properly and may cause overheating.

NOTICE

NEVER connect the ventilation system blower directly to the cooker flue opening. The direct flow of air will cause poor temperature recovery, poor ignition, inefficient operation of the cooker, and could extinguish the pilot.

Table 1-2 Ventilation and Fire Safety References

Topic	Underwriter Laboratory Document	National Fuel Gas Code Document
Grease Extractor	ANSI/UL 710-1981	ANSI/NFPA 96-1987
Ventilation Hood	ANSI/UL 705-1984	ANSI/NFPA 96-1987
Filter Unit	ANSI/UL 586-1985 ANSI/UL 900-1987	ANSI/NFPA96-1987
Types of Fire Extinguishers and Detection Equipment		
CO ₂	ANSI/UL 154-1983	ANSI/NFPA 12-1989
Dry Chemical	ANSI/UL 299-1984	ANSI/NFPA 17-1985
Water	ANSI/UL 626-1984	ANSI/NFPA 13-1989
Foam		ANSI/NFPA 11-1988
Sprinklers	ANSI/UL 199-1982	ANSI/NFPA 13-1989 ANSI/NFPA 13-1989
Smoke Detectors	ANSI/UL 268-1981	ANSI/FPA 72B-1986
Fire Detection Thermostats	ANSI/UL 521-1987	ANSI/FPA 72B-1986

1.3.6 Inspection

When the installation of the cooker is completed, it must be inspected by the local authorities.

1.4 Initial Adjustments

After the cooker has been installed, it needs to be adjusted to ensure that it will perform as designed. These adjustments must be performed by a qualified person. The following tools will be needed to perform these adjustments:

- Manometer (low pressure gage)
- Digital Thermometer (Temperature probe)
- DC Millivolt Meter

1.4.1 Visual Checks

Before filling and adjusting the cooker, perform the following visual checks:

- After the cooker is in its permanent location, lock the casters (if used), and ensure the cooker is level. Any additional leveling that is necessary can be performed as described in section 1.2.
- Check the temperature bulbs, located in the cooker tank, to ensure that the mounting screws are tight. Look down inside the cooker tank to see the probes.

1.4.2 Filling the Pasta Cooker

To fill the cooker with water, use the optional manual water fill valve or the faucet on the rinse tank. Allow the tank to fill until the desired level is reached. During normal operation the water will boil away. Replace water as needed to keep water at the full level.

NOTICE

If cold water is used to fill the cooker, it will take at least twenty minutes for the cooker to reach operating temperature.

1.4.3 Pilot Light System

The Pasta cooker uses a manual pilot light system to light the main burner. The pilot light receives its gas supply through an electrically controlled Unitrol gas valve. Perform the procedure that follows to light the pilot:

WARNING

Ensure the burner tubes are completely covered with water before lighting the pilot or main burner. If the main burners are lit without the burner tubes being covered, the cooker may overheat, damaging the kettle, voiding the warranty, and creating a fire hazard.

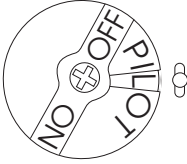
- a. Open the gas cock valve(s) to the cooker. (Some installations may not have these valves.)
- b. Make sure the POWER switch is OFF.
- c. Turn the gas control valve knob to the PILOT position and push in on the knob. Hold the knob in for approximately one minute to purge air out of the line. 
- d. Hold a flame to the pilot until the pilot ignites. This may take a little while the first time because of air in the line.
- e. After the pilot lights, hold the gas valve knob in for approximately 60 seconds and then release. The pilot should remain lit.
- f. If the pilot goes out after releasing the gas control valve knob, turn the gas control valve knob OFF.

WARNING

Wait five (5) minutes before attempting to relight the pilot. This will allow for any gas in the unit to dissipate.

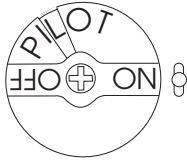
- g. Wait five (5) minutes and repeat steps c, d, and e. If after three tries the pilot will not remain lit, contact a qualified service technician. 
- h. Turn the gas control valve knob counterclockwise to the ON position.

1.4.3.1 Pilot Flame Adjustment

The pilot flame should be adjusted to produce between 350 and 450 millivolts output for the thermopile and 30 to 40 millivolts for thermocouples. The figure on the following page shows the pilot assembly with examples of incorrect and correct pilot size. Figure 1-1A illustrates a pilot flame size that is too small to produce sufficient millivolt output. Figure 1-1B presents the correct flame size to produce proper millivolt output.

- a. This test requires a DC millivolt meter set to a scale of 0-1000 millivolts. Test leads with sharp probes will help in taking the required reading.
- b. Locate the thermopile wires coming from the thermopile going to the gas shut off valve. The wire insulation size decreases near the gas valve connections.
- c. Attach the Negative test probe to the pilot bracket or suitable ground.
- d. Connect the Positive test lead to either terminal on the High Temperature Limit switch.

1.4.4 Main Burner System

For the main burner to work, the gas supply valve must be open and the main power switch must be on. The main burner receives gas from the main gas supply through a thermostatically controlled gas valve. When the thermostat calls for heat, the gas control valve opens. After the burner system is operating, perform the burner adjustments in the following procedure. Figure 1-3 illustrates the different conditions possible for the main burner.

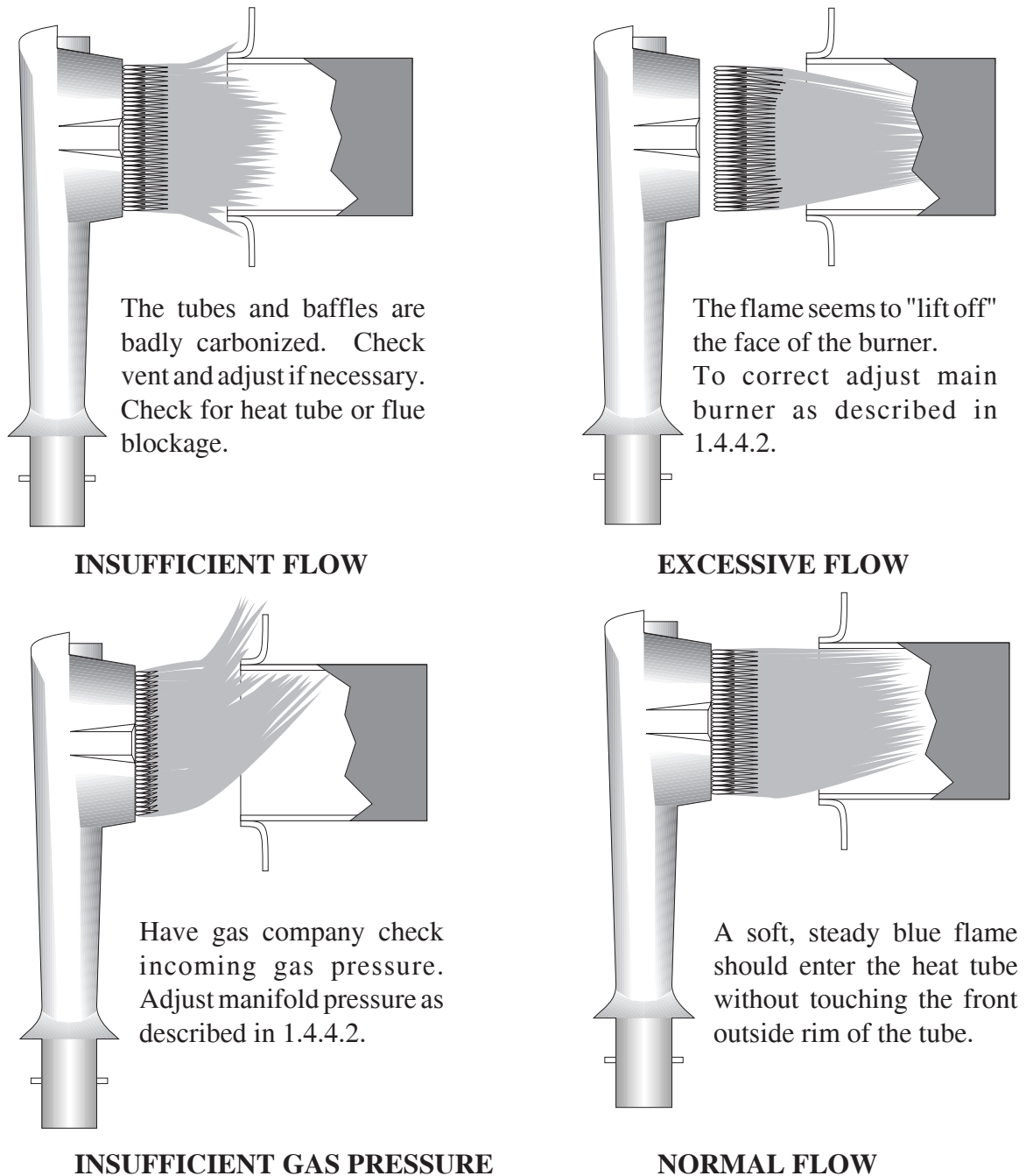

Figure 1-3 Main Burner Conditions

1.4.4.1 Gas Line Requirements

A properly installed gas supply system will deliver 7.0 +/- 2.0" w.c. natural gas (11.0 +/- 2.0" w.c. LP) to all appliances connected to the line, operating at full demand.

1.4.4.2 Main Burner Adjustment

The burner must be adjusted to deliver an optimum flame. Adjust the burner flame using the following procedure:

- a. Turn off all the appliances connected to the gas supply line.
- b. Ensure the main gas valve is shut off.
- c. Remove the manifold pressure tap plug and connect an accurate pressure gauge (range of 0-16" w.c. in 0.1" increments) or manometer (Figure 1-4).

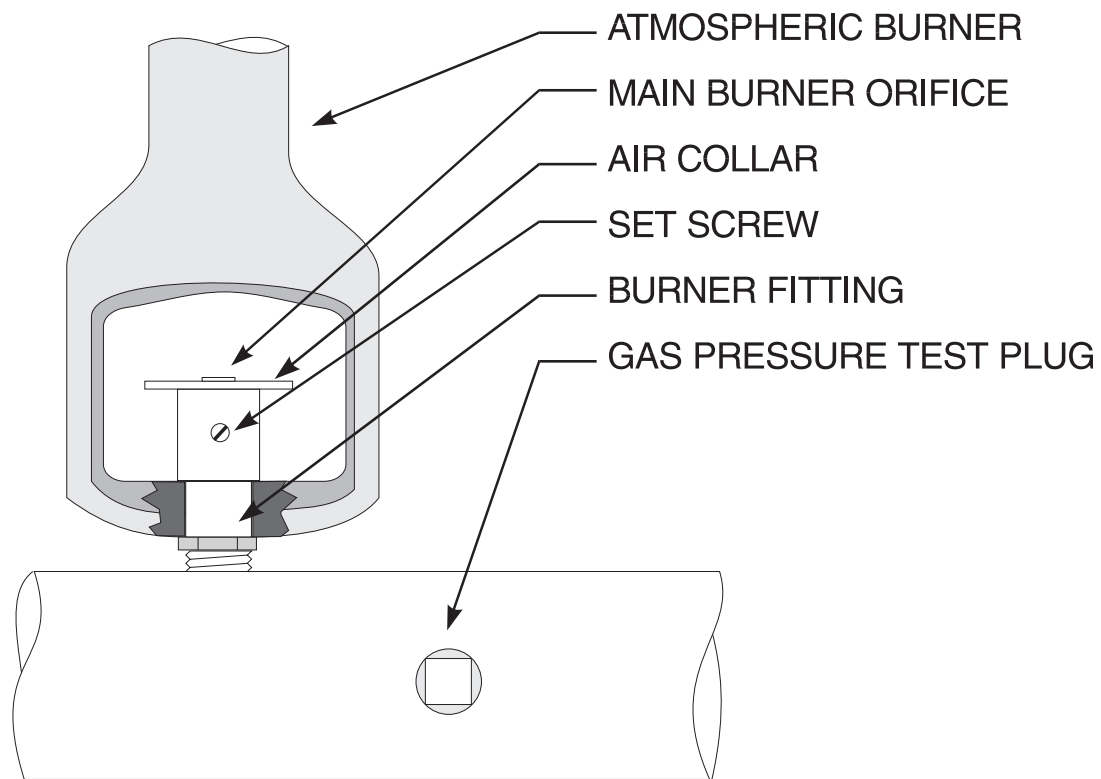



Figure 1-4 Gas Manifold with Burner

- d. Turn on all appliances connected to the gas supply line and light their main burners. The pressure reading of the installed pressure gauge should not drop from the required installation pressure.

- e. Light the pilot light for the cooker following the procedures in section 1.4.3 and turn the POWER switch ON to light the main burner. If the unit is equipped with the digital controller, press the on key . If the unit is equipped with manual controls, place the FUNCTION SELECT switch on BOIL to keep the main burner on during the adjustment.
- f. The installed pressure gauge reading should be the same, ± 0.1 ", as the pressure marked on the data plate inside the door. If the pressure is correct go to step i; if not, adjust the pressure.
- g. To adjust the pressure, remove the regulator adjustment screw cover. (Figure 1-2) Use a flat tip screwdriver to adjust the screw until the proper pressure is reached. Turn the screw clockwise to increase the pressure, turn counterclockwise to decrease the pressure.
- h. When the pressure is correct, install the regulator adjustment screw cover.
- i. Turn the cooker off and turn the gas control valve to OFF.
- j. Remove the pressure gauge and install the pressure tap plug.
- k. Once the pressure is set for proper operation, set the main burner flame size.
- l. Unlock the air collars by loosening the set screw for the collars. (Figure 1-4)
- m. Light the pilot light for the cooker following the procedures in section 1.4.3 and turn the POWER switch ON to light the main burner. If the unit is equipped with the digital controller, press the on key . If the unit is equipped with manual controls, place the FUNCTION SELECT switch on BOIL to keep the main burner on during the adjustment.
- n. The flame should enter the heat tube without touching the outside rim and it should not "lift off" the burner face. (Figure 1-3)
- o. Adjust the shape and size by raising or lowering the air collars to achieve a soft blue flame with well defined inner cones. Yellow flame tips should not be seen. Yellow flame tips indicate there is not enough combustion air.
- p. When the flames have been properly adjusted, lock the collars in place with the set screw provided.

1.4.5 Initial Cleaning

WARNING

The power supply must be disconnected before servicing or cleaning the appliance.

When the cooker is shipped, many of its parts are covered with a thin coat of shortening for protection. Before the cooker is ready for use, it must be cleaned to remove the oil coating and any foreign matter that may have accumulated during storage and shipment. Perform the cleaning as described below.

NOTICE

This is the first time the cooker will be turned on since leaving the factory. Be watchful for any signs of trouble or unusual activity. When a new piece of equipment is energized, unusual odors may be apparent as new components heat up. This is normal. IF odors persist or if excessive smoke is seen, turn the power to the cooker OFF at the facility service panel. Have a qualified technician check out the cooker for the cause.

- a. Ensure that the drain valve is closed.
- b. Fill the tank with water and add a packet of Pitco Fryer Cleaner to the water.
- c. Turn the cooker on and allow it to reach normal operating temperature. Allow the unit to soak at normal operating temperature (SIMMER) for fifteen (15) minutes to remove the coating.
- d. Use the cleaning brush supplied with the cooker to clean the tank.
- e. When the cleaning is complete, turn the cooker off.
- f. Drain the water.
- g. When the tank has cooled, rinse it thoroughly with cool water. Continue to rinse the tank until all debris has been rinsed from the tank.
- h. Now that the tank is clean, the cooker can be filled and operated.

1.5 High Temperature Limit Switch

Gas Pasta Perfect cookers are equipped with High Temperature Limit switches. The High Temperature Limit switch will shut the cooker down if the temperature reaches 250°F. This is to protect the cooker in the event the water is drained from the tank while the unit is on. Let the cooker cool down to reset the High Temperature Limit switch. After the cooker is cooled down, press the red reset switch, located inside the cooker mounted to the cabinet, to reset the High Temperature Limit switch.

CHAPTER 2: OPERATING INSTRUCTIONS

This chapter describes how to operate your Pasta cooker to obtain the best performance. Read the safety notices located in the front of this manual before operating the cooker. It is also important to read this manual to familiarize yourself with the cooker before you begin cooking. Ensure that it has been cleaned properly before using it to prepare food.

2.1 Filling the Cooker

The water level of the cooker is maintained manually by using the optional water fill system or the faucets above the rinse tank. It is important to keep the cooker full of water to minimize the chance of boiling the unit dry and to keep the water at optimum cooking levels. To keep the water temperature at its normal operating temperature and prevent rapid temperature changes, it is best to add water in small amounts.

2.2 Cooker Start-Up

There are two control systems available for the Pasta Perfect system, Digital Controller and Manual. Both systems use the steps in this section. After performing these steps, refer to the unit specific sections to complete the start up.

- a. Ensure the drain valve is closed.
- b. Fill the cooking tank with clean water.
- c. Light the pilot as described in section 1.4.3.

2.2.1 Digital Controller

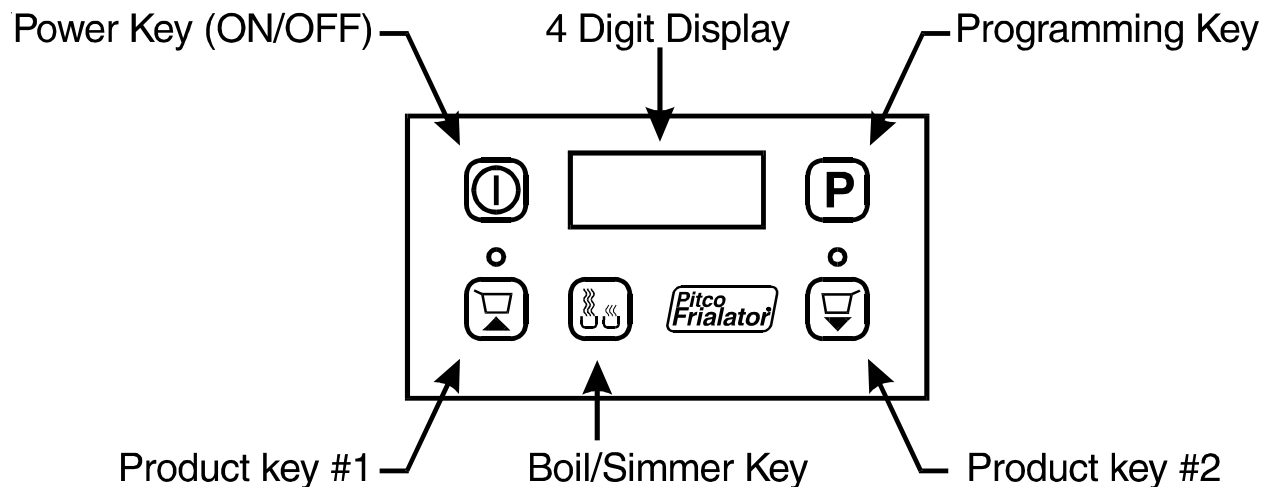



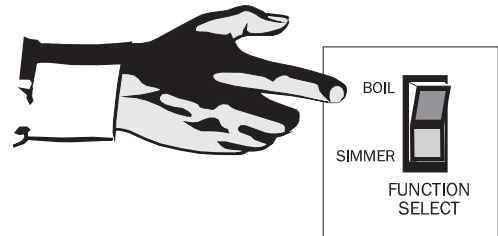

Figure 3-1 Digital Controller

- a. Press the On key . The display will light and the cooker will go onto simmer mode. In simmer mode the controller will maintain the water temperature at the user specified setpoint.
- b. Press the Boil/Simmer key  to raise the water temperature to boiling. The main burners will light and stay on continuously, bringing the water to a boil. After the water starts to boil, the cooker is ready to cook the pasta. As long as the controller is in the Boil mode the main burners will remain on.
- c. To return to the Simmer mode press the Boil/Simmer key  again.

2.2.2 Manual Controls

- a. Place the POWER switch in the ON position.
- b. Place the FUNCTION SELECT switch in the BOIL position. The main burners will light and stay on continuously, bringing the water to a boil. After the water starts to boil, the cooker is ready to cook the pasta. As long as the FUNCTION SELECT switch is in the BOIL position the main burners will remain on.



- c. If you are not ready to cook, place the FUNCTION SWITCH in the SIMMER position. This will cause the main burner to shut off and the internal thermostat to maintain the water temperature at around 190°F.



2.3 COOKING

NOTICE

For best performance (and to achieve rated cooking performance) add 1/2 cup of oil per pasta load to the water. Maintain the water level at the full mark during the cooking cycle.

With the cooker in the Boil mode, use the procedure below for the type of controls installed on your unit.

2.3.1 Digital Controller

- a. Place the pasta basket onto the basket lift (optional).
- b. Place the bulk pasta product to be cooked in the basket.
- c. Press the desired product key  or . The digital controller time cycle will start. If the unit is equipped with basket lifts, the lift will lower the pasta into the water.
- d. Stir the product and add oil as necessary to prevent sticking and excess starch buildup.
- e. At the end of the preset cooking time, the basket lift will raise the basket out of the tank.
- f. Hang the basket on the rinse section rack and rinse the pasta thoroughly with cold water. This will stop the cooking action, prevent sticking, and remove dissolved starch.
- g. The product is now ready to be served according to established procedures.

2.3.2 Manual Controls

- a. Place the pasta basket onto the basket lift.
- b. Place the bulk pasta product to be cooked in the basket and lower the basket into the water.
- c. Stir the product as necessary to prevent sticking.
- d. When the pasta is done lift the basket out of the water.
- e. Hang the basket on the rinse section rack and rinse the pasta thoroughly with cold water. This will stop the cooking action, prevent sticking, and remove dissolved starch.
- f. The product is now ready to be served according to established procedures.

2.4 Cooker Shutdown

There are two shutdown modes: STANDBY and COMPLETE. The standby mode removes the ability for the cooker's main burners to cycle. Complete shutdown turns off the gas supply to the unit.

STANDBY Press the On/Off key  for digital controller units, or place the POWER switch in the OFF position for manual units. Turn the gas control valve clockwise to the PILOT position. The cooker is now in Standby and can remain this way for brief periods of time. NEVER leave the cooker in standby overnight.

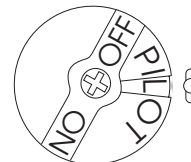

COMPLETE To completely shut down the cooker, press the On key  for digital controller units, or place the POWER switch in the OFF position for manual units.. Turn the gas control valve clockwise to the PILOT position. Then depress the gas knob and continue turning it clockwise to the OFF position.



2.5 Electric Power Failure

If electric power is removed for any reason, the cooker will shut down, but the pilot will remain lit. To restart the cooker, follow the cooker start up procedures in 2.2.

2.6 DAILY CLEANING

WARNING

The power supply must be disconnected before servicing or cleaning the cooker.

Proper cleaning of the tank is necessary to ensure proper performance from your Pasta cooker as well as the continued high quality of your pasta dishes. All surfaces should be scrubbed daily to maintain peak performance and appearance. Use warm water with a mild detergent to clean surfaces. Wipe down the cooker using a clean soft cloth to clean up excess water.

2.7 Weekly Cleaning

The continuous filling and evaporation of water from the cooker will cause deposits to build up around the tank. At least once a week the unit should be thoroughly cleaned to remove these deposits and generally clean the unit. Perform the cleaning as described below:

- a. Ensure the drain valve is closed. Fill the cooking tank with water and add a packet of Pitco Fryer Cleaner.
- b. Ensure the POWER switch is OFF.
- c. Turn the gas control valve knob to the PILOT position, push the knob in, and hold it.
- d. Hold a flame to the pilot until the pilot ignites.
- e. Turn the gas control valve knob to the ON position.
- f. Turn the POWER switch ON.
- g. Turn the FUNCTION SELECT switch to SIMMER and allow the cooker to reach normal operating temperature.
- h. Allow the cooker to soak for approximately twenty (20) minutes to remove deposits.
- i. Use the cleaning brush to remove any hardened deposits from the tank surfaces. Mild abrasives or scouring pads can be used to clean stains, if necessary. DO NOT use steel wool pads.
- j. When the cleaning is complete, turn the POWER switch OFF.
- k. Shut the gas valve off.
- l. Drain the water from the tank.
- m. When the tank has cooled, rinse it thoroughly with cool water. Continue to rinse the tank until all detergent has been rinsed away.
- n. Clean the holding tank with warm water and a mild detergent.
- o. Rinse the tank with cold water until all detergent has been rinsed away.
- p. Clean the exterior surfaces of the cooker with warm water and a mild detergent and wipe dry.
- q. The cooker is now ready to be used again.

CHAPTER 3: OWNER MAINTENANCE AND ADJUSTMENTS

This chapter provides the information and procedures necessary to perform basic cooker maintenance and adjustments. If your cooker does not perform properly after performing maintenance, contact your authorized service center. For repair, maintenance, or an explanation of any procedure, contact your dealer, local service company, the factory representative in your area, or the factory.

WARNING

The power supply must be disconnected before servicing or cleaning the cooker.

3.1 Thermostat Calibration - Manual Units ONLY

The Pasta cooker is equipped with a thermostat that controls the burners when the FUNCTION SELECT switch is in the SIMMER position. This thermostat should be set at approximately 190°F. At elevations above 5,000 feet, the thermostat setting should be decreased to 190°F. To change the thermostat setting, use the following procedure:

- a. Place an accurate thermometer in the center of the cooking tank with the bulb approximately 3" below the surface of the water. Allow enough time for the thermometer to stabilize.
- b. Using a flat tip screwdriver, turn the shaft on the thermostat clockwise to decrease the temperature setting; turn the shaft counterclockwise to increase the temperature setting. The thermostat is located on the left hand front wall of the tank. The shaft should not need to be turned more than 1/4 turn to adjust the temperature setting.

CAUTION

DO NOT turn the adjusting shaft more than two (2) turns in either direction.

3.2 Checking and Replacing Fuses

A general purpose ohmmeter or continuity checker is needed to check the control fuses. It is recommended that a qualified technician check the fuses. Use the following procedures to check and replace fuses:

WARNING

DANGER - HIGH VOLTAGE PRESENT

NEVER remove fuses from the cooker until the cooker is unplugged from the facility power supply.

- a. A fuse is located in a batonet type fuse holder located on bottom of the cabinet header.
- b. Remove the fuse from its holder by pushing in and turning 1/2 turn counter clockwise.
- c. Use an ohmmeter set on "x 1" ohms (resistance) setting to check the fuses for continuity. For a GOOD fuse, the meter reading should be approximately zero "0" ohms. If the reading is significantly above zero ohms, replace the fuse.
- d. Replace each fuse and ensure that it is secured in its fuse holder.
- e. Call a qualified technician if fuses continually blow.

3.3 Maintenance

NOTICE

A cooker that has casters will have a quick disconnect gas connection and a restraining device. Care should be exercised when moving the cooker out from the wall to be serviced. When moving the cooker back into place, ensure that the restraining device is connected properly. Be careful not to kink the gas hose.

3.3.1 Flue And Baffle Inspection

It is recommended that once every six months, with the cooker cooled down, the flue area be examined. Check for corrosion or blockage of the flue. Ensure that the cooker is shut down and do not turn the cooker on during the examination.

WARNING

Examination of the flue area during cooker operation may cause bodily injury.

3.4 Operator Troubleshooting

This section is provided to aid troubleshooting in the event of cooker failure. If this troubleshooting guide does not help correct the problem, contact a qualified technician.

