



MX-220-HT

Owner's Manual



Table of Contents

Product Introduction	Page 3
Explanation of Warning Messages	Page 4
Danger	
Warning	
Chemical Hazard	
Personal Injury	
Requirements for Detergents and Sanitizers	Page 5
Detergents	
Sanitizers	
Factory Assistance	
Operating Instructions	Pages 6-8
Filling The System	
Rinse Water	
Sanitizer Water	
Adding Detergents and Sanitizers	
Manual Dispensing	
Auto Dispensing	
Wash Cycle	
Controls & Features	Pages 9-14
Starting and Stopping the Wash Action	
Introducing Pots and Pans to the Power Soak	
Properly Scrapping Pots and Pans	
Loading and Using the Wash Sink	
Loading and Washing Utensils	
Unloading the Wash Sink	
Rinsing Pots & Pans	
Sanitizing Pots & Pans	
Drying of Pots & Pans	
Deep Cleaning and "Night Washing"	
Wash, Rinse and Sanitizer Clean-up	



Table of Contents - Continued

Preventive Maintenance	Pages 15-16
Routine Preventive Maintenance	
Daily	
Monthly	
Notes	
Troubleshooting	Pages 17-21
Facility Owner/Manager Section	
Authorized Service Agency Section	
Component Operation & Checks	Pages 22-30
Parts List	Pages 31-32
Electrical Schematic	Page 33
Pump and Motor Assembly	Pages 34-38
Installation	Pages 39-40
Electrical Requirements	
Providing Proper Electrical Service	
Plumbing Requirements	
Notes	



Product Introduction

Thank you for purchasing a *Power Soak* ware washing system.

Your new *Power Soak* pot, pan and utensil washing system will provide years of dependable, efficient and trouble-free service.

As a *Power Soak* owner, you will benefit in numerous ways:

- Your ware washing operation will be more efficient.
- Pots, pans and utensils will be cleaner.
- The overall level of sanitation in your scullery area will improve.
- Ware washing hours will decrease as employee morale increases.
- Chemical and water usage will decrease.

Every system is manufactured to last, with only high-quality, heavy-duty, 14 gauge stainless steel used in its construction. All electrical components used in a *Power Soak* system are of the highest quality. The faucets and drains are designed for quick filling and emptying of the system's sinks.

At Metcraft, we take pride in manufacturing the *Power Soak* line and are committed to standing behind our customers and products 100%. Should you ever need assistance, please contact us directly at the factory by dialing **800-444-9624** or fax: **816-761-0544**.

Explanation of Warning Messages

Be sure to read, understand and follow all DANGER, WARNING, and CAUTION messages located in this guide and on the equipment.

Danger

Personal Injury and Property Damage hazard.
May result in serious injury or death.
May cause extensive equipment damage

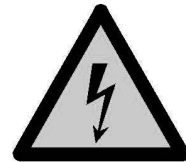

Warning

Property Damage Hazard.
May result in property or equipment damage.



Personal Injury Hazard

Hazard from sharp objects.
May result in serious injury or death.



Chemical Hazard

May result in serious injury or death. Instructions, labels and Material Safety Data Sheets (MSDSs) should be supplied with all detergents and sanitizing chemicals. The manufacturers, importers and distributors of your cleaning chemicals are responsible for providing this information.



Metcraft is not a chemical manufacturer, importer or distributor. Metcraft, Inc. can assist your chemical representative but will not make specific brand recommendations.

Power Soak[®] 

METCRAFT INC.



Requirements for Detergents and Sanitizers

Detergents

Remember, improper detergents may damage equipment! Use of the correct detergent in your *Power Soak* system is critical to its washing performance. If you are having problems with cleaning results, please contact the factory.

Your new system requires a low-foaming, metal/aluminum-safe detergent that is safe for the hands. The detergent should have good grease cutting abilities but not have an excessively high pH level.



Sanitizers

The method of sanitizing used in your *Power Soak* system is a "chemical sanitizing" method. There are a number of products on the market that work well. Your chemical sales representative should assist you in selecting the proper sanitizer for your application.

Check with your cleaning chemical provider to determine detergent concentration, sanitizer "parts per million" (ppm) and sanitizer submersion times to meet local health codes.

Factory Assistance

If your chemical sales representative is having difficulty selecting a detergent or sanitizer, or if you are getting poor results with the chemicals your representative has recommended, please contact the factory at **800-444-9624**.



MX-220-HT

Operating Instructions



Preparing the System

Filling the System

At the beginning of each day or shift, fill the sinks with water that is metered to approximately the correct operating temperatures:

- Wash sink (115°F / 48°C)
- Rinse sink (75°F / 24°C)
- Sanitizer sink (75°F / 24°C)

All sinks should be filled to, but not above, the “waterline” marks.

Fill the wash sink (the sink with the water jets) with water that is approximately 115°F / 48°C. You can use the hot and cold taps on the faucet to adjust the water to the appropriate temperature. A good rule of thumb is that the water should be hot to the touch but not so hot that it is uncomfortable.

Rinse Water

If your method for rinsing wares is of the “submersion” type, fill the rinse sink (middle sink) with water that is approximately room temperature, 75°F / 24°C. There is no need to fill the rinse sink if your location uses a sprayer for rinsing wares.

Sanitizer Water

Fill the sanitizer sink (the last sink) with water that is approximately room temperature, 75°F / 24°C.

Your Chemical Company Should Be Aware of the Following:

The detergent must be low foaming, metal/aluminum-safe and not excessively caustic. Most standard sanitizers are acceptable.



Adding Detergents & Sanitizers

Manual Chemical Dispensing

After the sinks have been filled with water, add the proper amount of detergent and sanitizer. The detergent goes into the wash sink (the sink with the water jets) and the sanitizer goes into the sanitizer sink (the last sink).

Be sure to add the proper amount of chemicals to each sink. The amount to be used should be provided by your chemical supplier. Do not add the detergent or sanitizer to the sink prior to or during filling.

Automatic Chemical Dispensing

Your *Power Soak* may be equipped with an automatic chemical dispensing system. Be sure to follow the chemical company's instructions regarding the use and care of the dispenser.

Wash Cycle

Most detergents and sanitizers lose effectiveness as time goes on. Some local health departments have requirements limiting the amount of time water can be used for cleaning before the water should be changed. Most chemical companies recommend changing wash water after a certain time frame. Those times vary, but are generally around four hours. Check with your chemical provider.

Your *Power Soak* sink is equipped with a timer preset at four hours. This means that your *Power Soak* will turn off four hours after pressing the start button.

The following steps should be taken after the sink times out:

- Empty the wash sink
- Refill with fresh water
- Add your detergent
- Press the Start button

Check with your chemical provider on how often to replace your sanitizer.

Power Soak[®] 

METCRAFT INC.



Controls and Features

Start Button (green)

Starts the washing action and starts the timer. Your *Power Soak* sink will run for four hours after this button is pressed.

Stop Button (red)

Stops the washing action and resets the timer.

Heat Switch (black on/off switch)

Turns on power to the heat control. The heat control measures the water temperature and decides whether to heat the water more.

Digital Display (heat control)

Not visible on all models. Shows you the current temperature of the water. This will only display when the heat switch is on.



Controls and Features - Continued

Starting and stopping the wash action

To start the wash action, press the green “START” button. A strong “rolling” wash action should be present.

To stop the wash action, press the red “STOP” button.

Introducing Pots and Pans to the PowerSoak

Dirty pots and pans should be brought to the *Power Soak* in a timely manner. **Do not allow items to sit and air dry.** The quicker that items are brought to the *Power Soak* and put in the wash tank, the easier they are to clean!

Properly Scrapping Pots and Pans

Excess soils should be removed from the pots and pans prior to dropping them in the wash sink.

Deposit the excess soils into a garbage can.

Some systems may have an optional pre-scrapping area with a pre-rinse spray. If so, soils may be deposited into the scrapper sink.



Controls and Features - Continued

Loading and Using the Wash Sink

The *Power Soak* is a “random loading” system. This means that *Power Soak* items are not racked for washing. Instead, they are randomly loaded one at a time.

As items are brought to the system and scrapped, they should be immediately dropped into the wash sink.

If there is no movement of items in the wash sink, or if items are stationary above the waterline, the system has been overloaded and some items must be removed.

It is very important not to overload the wash sink, as it reduces the effectiveness of the wash action.

Some pots and pans stack for storage. This is referred to as “nesting” when it occurs during a *Power Soak* wash cycle. Make sure that nested items are separated and loaded one at a time. Nested items in the wash sink will not be properly washed.

Power Soak is a “continuous motion” system. This means that the system does not operate on a set cycle time like cabinet-type washing systems. Instead, during normal operating hours where washing is required, the system is (normally) left running. The *Power Soak* is energy efficient, and it does not cause excessive wear to leave it running continuously.

Typically, it takes between three to fifteen minutes to wash items. Some heavily soiled or burnt-on items may take longer to clean.



Controls & Features - Continued

Loading and Washing Utensils

Each *Power Soak* system comes with a utensil basket that hangs in the wash sink. All utensils and other small wares should be loaded into and washed inside this basket.

Do not wash knives or other sharp objects in the Power Soak. Doing so may cause bodily injury.

Unloading the Wash Sink

The employee responsible for pot washing should routinely pass by the *Power Soak* and remove clean items from the wash sink.

Items that are not 100% clean can be quickly finished off with a scrub pad or dropped back into the wash sink for additional cleaning.

Remember: it is not necessary to turn the wash action off to load or unload items from the wash sink. There are no moving parts within the wash sink that could cause bodily harm.



Controls & Features - Continued

Rinsing Pots and Pans

Clean items that have been removed from the wash sink should be thoroughly rinsed. This is achieved by spraying them off or dipping them in the rinse sink (center).

It is important that any remaining detergent residue is removed from the items prior to sanitizing.

If items are rinsed by the "dipping" method, it is important to keep the water "fresh" by frequently draining and filling the rinse sink.

Sanitizing Pots & Pans

After items have been properly rinsed they must be sanitized in the sanitizing sink. (last).

It is necessary for each item to remain submersed in the sanitizing solution for a specific amount of time. The amount of time varies according to the type of sanitizer being used and local health codes.

Be sure to follow your chemical sales representative's instructions to ensure that all items are properly sanitized.

Drying of Pots & Pans

After items have been sanitized, they should be thoroughly dried on a clean drain board or on adjacent drying shelves.

Be sure to adhere to all local health codes and recommendations for proper drying and stacking of items.



Controls & Features - Continued

Deep Cleaning and "Night Washing"

Extremely soiled items and pieces of cooking equipment that require regular, intensive cleaning can be washed in the *Power Soak* system overnight.

Load the items to be deep cleaned into the Power Soak's wash sink, turn the system on and leave it running overnight.

The *Power Soak* will automatically shut down after the four-hour wash cycle, and the heater in the wash tank will keep the temperature of the water at a constant 115°F until the morning crew arrives.

Items that have been cleaned overnight can be removed, rinsed, sanitized (if necessary) and put away or back in place.

Use your *Power Soak* as a "total cleaning system!" Remember, any item in your operation that can be submersed for cleaning and is not fragile can be washed without labor in your *PowerSoak*!

Here are some examples of items that are typically deep-cleaned overnight in the "Night Wash" cycle:

- Hood Filters
- Roasting Pans
- Stove Tops
- Frying Equipment

Many other items in your operation may qualify. Be creative and set up a regular "Night Wash" program for improved sanitation.

Wash, Rinse and Sanitizer Clean-Up

Between each water change and at the end of each night, all tanks and drain boards should be thoroughly cleaned with hot, soapy water.

It is also recommended to wipe down all the tanks and drain boards with a sanitizing agent. Ask your chemical provider to recommend a sanitizer for this application.

Preventive Maintenance

Your system requires minimal, routine preventive maintenance. As such, the following should be done on a routine basis to ensure that your system remains reliable:

Daily

Clean the liquid level sensors. These sensors are located on the side walls of the wash and sanitizer tanks. They are the white plastic discs with metal centers. Clean the sensor faces thoroughly. If cleaned regularly, a washcloth and soapy water are all that is required.

If the liquid level sensors are not cleaned regularly, the machine may fail to operate; or it may be possible to run it without water, which may cause serious damage to the unit.



Monthly

IMPORTANT: Turn off the power to the unit at the main breaker prior to performing the following task!

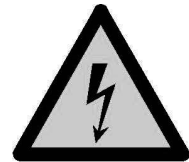

Clean the pump motor fan shroud with a damp, soapy rag. The motor shroud is the "vented" cover located at the end of the motor (closest to the control panel). This will prevent grease and dust from accumulating in the cover's openings, which can obstruct the airflow that cools the motor.

De-lime the wash sink. Simply add a de-liming agent to a sink of warm, fresh water and run the system overnight.

Ask your chemical sales representative to recommend a specific de-liming agent.

There are no other preventive maintenance procedures that you will need to perform on your *Power Soak* system. You need not be concerned about greasing the motor bearings, as they are permanently sealed. If you have any questions regarding the preventive maintenance procedures, please contact the factory at **800-444-9624**.



Notes



MX-220-HT

Troubleshooting



Facility Owner/Manager Section

The only troubleshooting procedure that the facility owner or manager can perform is listed immediately below. All other procedures must be performed by an authorized service agency. To obtain the name of a recommended service agent in your area, please call the Metcraft, Inc. *Power Soak* Service Department at **800-444-9624**.

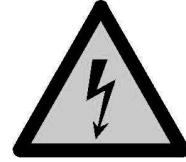

Pump and Heater do not work

Please perform the following in order:

- Drain the sink.
- Turn off the circuit breaker for your sink.
- Clean the liquid level sensor (LLS). This is located on the right or left inside wall (same side as control panel) of the wash sink, behind the removable baffle. The LLS is a white plastic disk with a silver metal center. Use warm soapy water.
- Fill the sink.
- Turn on the circuit breaker for your sink.
- Start the sink.

Authorized Service Agency Section

Hazard to untrained or unauthorized personnel.

The following procedures are provided for use only by an authorized service agency. No facility owner, manager, employee or other unauthorized person should attempt to perform any of these procedures. To obtain the name of a recommended service agent in your area, please call the Metcraft, Inc. *Power Soak* Service Department at **800-444-9624**.



When performing troubleshooting procedures, the authorized service agency will need to open the *Power Soak* system's main electrical enclosure.

Properly close the control panel before reconnecting the circuits.

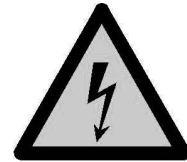

Refer to the previous checklist under the "Facility Owner / Manager Section" before proceeding to the following checklist items:



Pump and Heater do not work

Look For	Correction
1 No water in sink	Fill sink with water
2 LIQUID LEVEL SENSOR dirty	Clean LIQUID LEVEL SENSOR
3 No incoming power to unit	Reset customer's breaker in breaker control panel
4 Blown fuses	Replace blown fuse – Refer to wiring diagram for correct fuses
5 Loose wires	Tighten wires
6 LIQUID LEVEL SENSOR setting is too low	See page 23
7 Defective LIQUID LEVEL CONTROL or SOCKET	Check and replace as necessary



Authorized Service Agency Section - Continued

Heater works – Pump does not work

Look For	Correction
1 Tripped OVERLOAD	Push red RESET bar on OVERLOAD
2 Loose wires	Tighten wires
3 Defective START or STOP switch	Check and replace as necessary
4 Defective CONTACTOR/OVERLOAD	Check and replace as necessary
5 TIMER settings incorrect	Check – See page 24
6 Defective TIMER	Check and replace as necessary
7 Defective PUMP MOTOR	Check and replace as necessary

Overload trips

Look For	Correction
1 Low voltage to unit	Check with Volt meter while running
2 Debris in PUMP intake	Clean
3 Debris in IMPELLER	Remove PUMP and clean
4 Defective CONTACTOR	Check and replace as necessary
5 Defective OVERLOAD	Check and replace as necessary
6 Defective PUMP MOTOR	If amp draw is greater than 10% of motor rating and all of above check out, then replace MOTOR



Authorized Service Agency Section - Continued

Pump works – Heater does not work

Look For	Correction
1 Loose wires	Tighten wires
2 Defective SWITCH	Check and replace as necessary
3 Defective HEAT ELEMENT	Check and replace as necessary
4 Defective HEAT CONTROL	Check and replace as necessary
5 Defective THERMOCOUPLE	Check and replace as necessary
6 Defective HEAT CONTACTOR	Check and replace as necessary

Intermittent running

Look For
1 See 2,5,6,7 under Pump and Heater do not work
2 See 5, 6 under Heater Works – Pump does not work

Pump leaks

Look For	Correction
1 PUMP CASING PLUG loose or defective	Tighten or replace
2 Defective PUMP SEAL	Replace

Component Operation and Checks

The following checks should only be performed by qualified technicians using extreme caution.

Electrical hazard to untrained personnel may result in electrical shock, burns, or death.

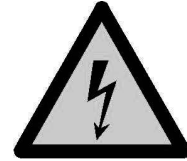

Heater Contactor

If there is 208v-230v across the coil and the contactor does not pull in, the contactor is defective. If there is 208v-230v across terminals L1 and L2 and the contactor is pulled in, but no voltage across terminals T1 and T2, the contactor is defective.

Heater Element

Check the heat element as follows:

1. TURN POWER OFF AT BREAKER PANEL.
2. Make sure the connections at terminals T1 and T2 on the heater contactor are tight and the heater contactor is open.
3. Check the resistance between terminals T1 and T2 on the heater contactor. Resistance should be 21 to 24 ohms. If not, the heat element is defective. If there is no resistance, check the wiring connections in the heater box before assuming the element is defective.
4. If there is no water in wash sink, fill until heat element is completely submerged.
5. Set test meter to read resistance and check for resistance between terminals T1 on the heater contactor and ground and T2 on the heater contactor and ground. If there is measured resistance to ground, the heat element is defective.

Heater ON/OFF Selector Switch

TURN POWER OFF AT BREAKER PANEL. In the "off" position, there should be no continuity across terminals 3 and 4. In the "on" position, there should be continuity between terminals 3 and 4. Remove the wires before checking for continuity.

Push ON / Push OFF Start and Stop Buttons

TURN POWER OFF AT BREAKER PANEL. The stop button should have continuity at rest and no continuity when pushed in. The start button should have no continuity at rest and continuity when pushed in. Remove the wires before checking for continuity.

Component Operation and Checks

Liquid Level Control and Sensor

The liquid level control sends a trickle current (1/1000 amp) out terminal 5 to the liquid level sensor. If there is water in the wash sink, the current passes through it to the wash sink wall and back to the liquid level sensor to terminal 6. On some machines, the wire from terminal 6 is hooked up to a second probe instead of the wash sink wall. Reversing these 2 wires will not affect the operation. After the circuit is complete, a 10 second time delay is initiated. The purpose of this delay is to prevent rapid cycling of the relay should the water rise and fall below the sensor while the sink is filling. At the end of the time delay, the relay in the liquid level control will close sending current to operate the various components in the control panel. If the red "power" light on the timer is on, the liquid level control is ok.

On some models, the sensitivity of the liquid level control is adjustable. To adjust the sensitivity, clean the liquid level sensor, **TURN POWER OFF AT BREAKER PANEL** and check the resistance between the liquid level sensor and the wash sink wall (or second probe). It should be 25,000 to 35,000 ohms. If not, adjust the sensitivity as required. 25,000 to 35,000 ohms is generally between 0 and 1 on the dial. If there is no resistance, the wires from terminal 5 and 6 to the liquid level sensor and sink wall are loose, or the liquid level control or socket is defective.

If adjusting the sensitivity setting does not allow the machine to operate, the liquid level control can be checked as follows:

1. Set sensitivity as indicated above
2. Make sure wash sink is filled to the fill line. If the red "power" light on the timer is on, the liquid level control is ok.
3. Remove liquid level control from socket.
4. Check voltage across terminals 2 and 7 of the socket and 1 and 7 of the socket. It should be 208v-230v. If no voltage, check the breaker, fuses, and wiring to the socket.
5. **TURN POWER OFF AT BREAKER PANEL.** Make sure there is continuity between terminal 3 of the socket and terminal 4 on the heat on/off selector switch. If not, trace the wire and make the necessary repair.
6. Reinstall the liquid level control. Wait 10 seconds and check the voltage across terminal 4 on the heat on/off selector switch and L2 incoming power. If no voltage, the liquid level control or socket is defective.

Component Operation and Checks

Timer

The timer controls how long the pump will run after the "start" push button is pushed in. Two different timers have been used. They function the same but the settings differ. The timer settings should be as follows:

	<u>ISSC Timer</u>	<u>IDEC timer</u>
MODE	SF	D
RANGE	HRS	10H
FACE NUMBERS	0 through 10	0 through 1
DIAL SETTING	4	4

When the "start" push button is pushed, the timer is activated and sends L1 power to terminal A1 on the motor starter/overload.

The timer can be checked as follows:

1. Make sure the timer is set as indicated above.
2. If the red "power" light is on, go to step 5.
3. Check voltage across terminal 10 on the timer socket and L1 incoming power. It should be 208v-230v. If there is no voltage, check the breaker, fuses, transformer and wiring.
4. Check voltage across terminal 2 on the timer socket and L2 incoming power and terminal 11 on the timer socket and L2 incoming power. It should be 208v-230v. If there is no voltage, check the breaker, fuses, transformer, liquid level control, stop switch and wiring. Make the necessary repair.
5. TURN POWER OFF AT BREAKER PANEL. Remove the timer from the socket.
6. Make sure there is continuity between terminal 9 on the socket and terminal 95 on the thermal overload. If not, trace the wire and make the necessary repair.
7. Make sure there is continuity between terminal 6 on the socket and terminal 3 on the "start" push button. If not, trace the wire and make the necessary repair.
8. Push and hold the "start" push button in and check for continuity between terminals 3 and 4 on switch. If there is no continuity, replace the "start" switch.
9. Reinstall the timer and turn power on. Wait 10 seconds for the liquid level control to activate. The red "power" light should come on.
10. Check voltage across terminal 4 on the "start" push button and L2 incoming power. It should be 208v-230v. If there is no voltage, trace the wire to the "stop" switch and make the necessary repair.
11. Push and release the "start" push button. Check voltage across terminal 95 on the thermal overload and L2 incoming power. It should be 208v-230v. The green "OP" light should flash on the ISSC timer. The red "OUT" light should illuminate on the IDEC timer. If there is no voltage, the time is defective.

Component Operation and Checks

Pump Contactor

The thermal overload can be checked as follows:

1. If there is 208-230v across the coil (terminals A1 and A2) and the contactor does not pull in, the contactor is defective.
2. TURN POWER OFF AT BREAKER PANEL.
3. Remove the wires from terminals T1 and T3 on the thermal overload.
4. Push the contactor closed manually and check for continuity across pump contactor terminals L1 and T1, L2 and T2, L3 and T3. If no continuity on any of these, the contactor is defective.

Thermal Overload

The blue reset button should be in the down position (automatic reset). The dial should be set at 10. The trip indicator is located between the dial and the symbols "LR2".

The thermal overload can be checked as follows:

1. TURN POWER OFF AT BREAKER PANEL. Remove the wires from terminals 95 and 96.
2. Make sure the thermal overload is not tripped. If the thermal overload is tripped, reset it. If the thermal overload has tripped recently, you may have to wait several minutes for it to cool down before it will reset.
3. Check for continuity across terminals 95 and 96. If no continuity, the thermal overload is defective or the reset is tripped.
4. Make sure the T1, T2, and T3 terminals on the pump contactor are tight.
5. Remove the wires from terminal T1 and T3 on the thermal overload.
6. Check for continuity across T1 on the pump contactor and T1 on the overload, T2 on the pump contactor and T2 on the overload, T3 on the pump contactor and T3 on the overload. If no continuity on any of these, the overload is defective.



Component Operation and Checks

Heater Controller

The heat controller controls the wash tank temperature. On some models, this display is not visible. If the display is visible, the Heat Control is made by either Watlow, or RKC. They function similarly, but are visually different. If the display is not visible, the Heat Control is made by RKC.

Wiring configuration

<u>Wire Description</u>	<u>Watlow</u>	<u>RKC</u>
Thermocouple red (-)	Pin 1	Pin 9
Thermocouple white (+)	Pin 2	Pin 8
L1 from heat switch (black)	Pins 6 & 7	Pins 1 & 4
L2 from heat contactor (white)	Pin 1	Pin 2
Signal to heat contactor (red)	Pin 5	Pin 3

Watlow Heat Control

The red illuminated display will indicate the actual temperature on top and the set temperature on the bottom. The set temperature is displayed when the “set” button is pushed. To adjust the set temperature, push and hold the “set” button and push the “arrow up” or “arrow down” button. The range of adjustment is typically 114°F to 118°F. If the water temperature falls below 110°F, the display will flash “LO”. If the water temperature rises above 120°F, the display will flash “hI”. The red indicator light at “2” will light when the controller is sending current to the heater contactor.

The Watlow heat controller will display the following error messages to assist in troubleshooting:

Note: Excessive moisture can cause these error messages.

<u>DISPLAY</u>	<u>PROBABLE CAUSE</u>	<u>RECOMMENDED ACTION</u>
Er 2	Programming error	See programming on page 28
Er 4 , Er 5	Microprocessor defective	Replace heat controller
Er 6 , Er7	Thermocouple defective, loose, broken wire	Check the thermocouple connections and thermocouple. Replace as necessary.

Component Operation and Checks Watlow Heater Controller - Continued

The Watlow heat controller can be checked as follows:

1. Make sure the heat controller is wired as indicated above. Turn heater on/off selector switch to "on".
2. If the heat controller is displaying any of the above error messages, take the recommended action. If there is no display, go to step 4. If the heat controller is displaying the actual and set temperature, go to step 7.
3. Program the heat controller. See programming on page 28. If the heat controller cannot be programmed or programming does not correct the display, replace the heat controller.
4. Check voltage across terminal 7 on the heat controller and L2 incoming power, and terminal 6 on the heat controller and L2 incoming power. It should be 208v-230v. If not, check the breaker, fuses, switch, liquid level control and wiring. Make the necessary repair.
5. Check voltage across terminal 8 on the heat controller and L1 incoming power. It should be 208v-230v. If not, check the breaker, fuses, transformer and wiring. Make the necessary repair.
6. If the voltage checks ok in step 4 and 5 and the display is not lit, the heat controller is defective.
7. Adjust the set temperature to 120 degrees as indicated above. If the set temperature will not adjust, go to step 3.
8. Make sure actual temperature is less than 115 degrees. Check voltage across terminal 5 on the heat controller and L2 incoming power. It should be 208v-230v. If no voltage, the heat controller is defective. Note: The red indicator light at "2" should also be on.
9. Adjust the set temperature to 114 degrees as indicated above.
10. Make sure the actual temperature is greater than 116 degrees.
11. There should be no voltage across terminal 5 on the heat controller and L2 incoming power. If there is 208v-230v, the heat controller is defective. Note: The red indicator light at "2" should be off.



Component Operation and Checks

Programming the Watlow Heat Controller

1. Push "up" and "down" arrows simultaneously for 5 seconds. The display should read "CnF9". If not, push the "down" arrow repeatedly until it does.
2. Push and hold the "set" button. The display will read "no". Change to "YES" by pushing the "up" arrow. Release the "set" button.
3. The display should read "tA9". If not, push the "up" arrow repeatedly until it does. Push and hold the "set" button. Push the "up" arrow repeatedly until the screen goes blank. Release the "set" button.
4. Press the "down" arrow. The display will read "In". Push and hold the "set" button. The display should read "J". If not, adjust by pushing the "up" arrow. Release the "set" button.
5. Press the "down" arrow. The display will read "C_F". Push and hold the "set" button. The display should read "oF". If not, adjust by pushing the "up" arrow. Release the "set" button.
6. Press the "down" arrow. The display will read "rL". Push and hold the "set" button. The display should read "114". If not, adjust by pushing the "up" or "down" arrow[‡]. Release the "set" button.
7. Press the "down" arrow. The display will read "rh". Push and hold the "set" button. The display should read "118". If not, adjust by pushing the "up" or "down" arrow. Release the "set" button. Return to step 6 if necessary.
8. Press the "down" arrow. The display will read "Ot1". Push and hold the "set" button. The display should read "ALM". If not, adjust by pushing the "up" arrow. Release the "set" button.
9. Press the "down" arrow. The display will read "Ot2". Push and hold the "set" button. The display should read "hEAt". If not, adjust by pushing the "up" arrow. Release the "set" button.
10. Press the "down" arrow. The display will read "dl5P". Push and hold the "set" button. The display should read "Ac". If not, adjust by pushing the "up" arrow. Release the "set" button.
11. Press the "down" arrow. The display will read "ALtY". Push and hold the "set" button. The display should read "Prno". If not, adjust by pushing the "up" arrow. Release the "set" button.

[‡] If the display will not go to 114, perform step 7 first, then return to step 6.



Component Operation and Checks

Programming the Watlow Heat Controller

12. Press the “down” arrow. The display will read "AhY5". Push and hold the “set” button. The display should read “1”. If not, adjust by pushing the “up” arrow. Release the “set” button.
13. Press the “down” arrow. The display will read "LAT". Push and hold the “set” button. The display should read “no”. If not, adjust by pushing the “up” arrow. Release the “set” button.
14. Press the “down” arrow. The display will read "5 IL". Push and hold the “set” button. The display should read “no”. If not, adjust by pushing the “up” arrow. Release the “set” button.
15. Press the “down” arrow. The display will read "FAIL". Push and hold the “set” button. The display should read “6PL5”. If not, adjust by pushing the “up” arrow. Release the “set” button.
16. Press the “down” arrow. The display will read "5LOC". Push and hold the “set” button. The display should read “no”. If not, adjust by pushing the “up” arrow. Release the “set” button.
17. Push "up" and "down" arrows simultaneously for 5 seconds. The display will read the actual temperature. It may also flash “LO” or “hI”. If an accurate reference thermometer is available, measure the temperature in the wash sink. Compare to the reading on the heat controller and note the difference (thermometer reading minus heat control reading). This number will be used in step 24.
18. Push "up" and "down" arrows simultaneously for 5 seconds. The display will read “AUT”. It may also flash “LO” or “hI”. Push and hold the “set” button. The display should read “no”. If not, adjust by pushing the “up” arrow. Release the “set” button.
19. Press the “down” arrow. The display will read "ALO". It may also flash “LO” or “hI”. Push and hold the “set” button. The display should read “110”. If not, adjust by pushing the “up” or “down” arrow[§]. Release the “set” button.
20. Press the “down” arrow. The display will read "Ah1". It may also flash “LO” or “hI”. Push and hold the “set” button. The display should read “122”. If not, adjust by pushing the “up” or “down” arrow. Release the “set” button. Return to step 19 if necessary.

[§] If the display will not go to 110, perform step 20 first, then return to step 19.



Component Operation and Checks

Programming the Watlow Heat Controller

21. Press the “down” arrow. The display will read "P,d". It may also flash “LO” or “hI”. Push and hold the “set” button. The display should read “no”. If not, adjust by pushing the “up” or “down” arrow. Release the “set” button.
22. Press the “down” arrow. The display will read "Pb h". It may also flash “LO” or “hI”. Push and hold the “set” button. The display should read “0”. If not, adjust by pushing the “down” arrow. Release the “set” button.
23. Press the “down” arrow. The display will read "hY5h". It may also flash “LO” or “hI”. Push and hold the “set” button. The display should read “2”. If not, adjust by pushing the “down” arrow. Release the “set” button.
24. Press the “down” arrow. The display will read "CAL". It may also flash “LO” or “hI”. Push and hold the “set” button. The display should read the number determined in step 17. If not, adjust by pushing the “down” arrow^{**}. Release the “set” button.
25. Push "up" and "down" arrows simultaneously for 5 seconds. The display will read the actual temperature. It may also flash “LO” or “hI”. Release the “up” and “down” arrows.
26. Push "up" and "down" arrows simultaneously for 5 seconds. The display will read “AUT”. It may also flash “LO” or “hI”. Release the “up” and “down” arrows. Push the “down” arrow repeatedly until the display reads "CnF9".
27. Push and hold the “set” button. The display will read “no”. Change to “YES” by pushing the “up” arrow. Release the “set” button.
28. The display will read “In”. Push the “up” arrow.
29. The display will read "tA9". Push and hold the “set” button. The display will go blank. Push the “down” arrow. The display will read “PCOA”. Release the “set” button.
30. Push "up" and "down" arrows simultaneously for 5 seconds. The display will read the actual temperature. It may also flash “LO” or “hI”. Release the “up” and “down” arrows.

The Watlow heat control is now programmed.

**** If a thermometer was not available for step 17, use zero.

Component Operation and Checks RKC Heater Controller

The set temperature will be shown in the red illuminated display on the top right corner. The actual temperature will be shown in the green illuminated display in the center. The set temperature will then start blinking. You then push the "arrow up" or "arrow down" button to the temperature setting you would like. When finished, press the "set" button again. The range of adjustment is typically 114 to 120 degrees.

The **RKC** heat control is pre-programmed. There is no programming required.

There are three messages that may show up different than above:

- "uuuu" – This means that the current temperature of the water is below the operating range (114°F-120°F). This is normal after filling the sink with water below 114°F, and the heat contactor is pulled in (heating). If the heat contactor is not pulled in, there is a problem. See troubleshooting guide.
- "oooo" – This means that the current temperature of the water is above the operating range (114°F-120°F). This is normal after filling the sink with water above 120°F, and the heat contactor is not pulled in (not heating). If the heat contactor is pulled in, there is a problem. See troubleshooting guide.
- "Err" – If this happens, call the Metcraft service department at **800-944-0404**.

The **RKC** heat control pins are marked, but may be difficult to identify. The following diagram maps the pin locations. Note the three gold pins as reference:

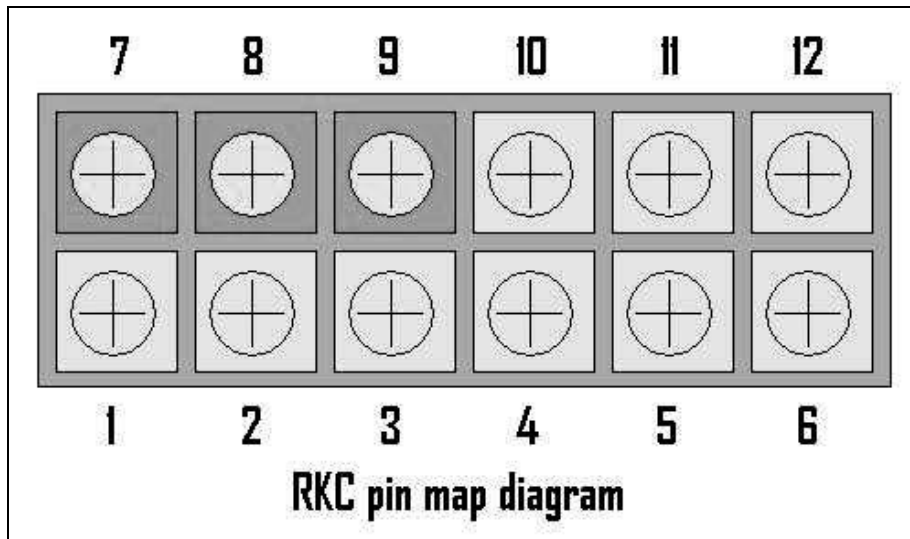

Parts List

Pump Parts

29501	MOTOR-LEESON 2HP 230V
29507	MOTOR-LEESON 2HP 208V
26572	FAN-BALDOR MOTOR
29743	PUMP WITH MOTOR, IMPELLER AND CASING GASKET (W/B 2HP)
21356	FRAME ADAPTOR WITH WEAR RING
22446	SHAFT SLEEVE
25976	SNAP RING
21884	IMPELLER
25975	IMPELLER KEY
19345	GASKET-PUMP CASING (W)
24463	SEAL KIT-PUMP
RS1011	PUMP CLEANOUT PLUG

Heater Parts

23985	GASKET-HEATER BOX (SERIAL #'S 1000-1349)
24181	HEATER BOX RIGHT HAND UNITS (SERIAL #'S 1000-1349)
24179	HEATER BOX LEFT HAND UNITS (SERIAL #'S 1000-1349)
24849	GASKET-HEATER BOX (SERIAL #'S 1350 AND UP)
24848	HEATER BOX RIGHT HAND UNITS (SERIAL #'S 1350 AND UP)
24847	HEATER BOX LEFT HAND UNITS (SERIAL #'S 1350 AND UP)
28925	MODIFIED HEATER BOX LEFT HAND UNITS (SERIAL #'S 1350 AND UP)
28926	MODIFIED HEATER BOX RIGHT HAND UNITS (SERIAL #'S 1350 AND UP)
21457	SWITCH OPERATOR-HEATER
23727	SWITCH BLOCK-HEATER
CB1327	CAP NUT (4)
21203	VENT PLUG
18797	TERMINAL BLOCK
23983	DECAL-HEATER BOX
23987	SENSOR PROBE
23988	GASKET-SENSOR PROBE
24030	THERMOCOUPLE
19443	GASKET-THERMOCOUPLE
19296	QUENCH ARC
23986	HEAT CONTROL
25757	GUARD PLATE-HEAT CONTROL
25539	BUTTON ASSEMBLY & BEZEL-HEAT CONTROL
17263	SINK HEATER
17137	GASKET-HEATER
17127	STUD #10-24 X ¾" (4)
CB1327	NUT CAP #10-24 RUBBER SEAL (4)

Parts List - Continued

Control Panel Parts

103-052	SCREW-CONTROL PANEL (2)
23949	GASKET-CONTROL PANEL
23894	START SWITCH-PUSH BUTTON
23895	STOP SWITCH-PUSH BUTTON
23896	SWITCH BLOCK-STOP
23727	SWITCH BLOCK-START (SERIAL #S 1026 AND ABOVE)
21458	SWITCH BLOCK-START (SERIAL #S 1000-1025)
29444	CONTACTOR-PUMP
17394	CONTACTOR-HEATER
24223	TIMER
24224	SOCKET, TIMER
19885	LIQUID LEVEL CONTROL
21473	SOCKET, LIQUID LEVEL CONTROL
21472	HOLD DOWN CLIP, LIQUID LEVEL CONTROL (2)
23579	FUSE BLOCK, MAIN
23580	MOUNT-FUSE BLOCK
RS1471	GROUDING BLOCK
20281	FUSE BLOCK, CONTROL CIRCUIT
20637	FUSE 1 BUSSMAN LP-CC-30 (2)
20280	FUSE 3 BUSSMAN ABC 2
29939	OVERLOAD
27833	#10-24 THREADED STUD (6)
103-020	HEX NUT 1/4" X 20 (6)
103-014	NUT SERT #10-24 (2)

Miscellaneous Parts

24724	INTAKE BAFFLE (SERIAL #'S 1000-1349)
24853	INTAKE BAFFLE 28" (SERIAL #'S 1350 AND UP)
24860	INTAKE BAFFLE 25" (SERIAL #'S 1350 AND UP)
24841	INSIDE HEATER COVER (BEFORE 3/1/99 SLIDE ON-SLIDE OFF)
24936	INSIDE HEATER COVER (AFTER 3/1/99 HINGED)
100-343	"O" RING - LEVER DRAIN

Electrical Schematic

This schematic reflects the wiring for a RKC heat control, which replaces the Watlow heat control.

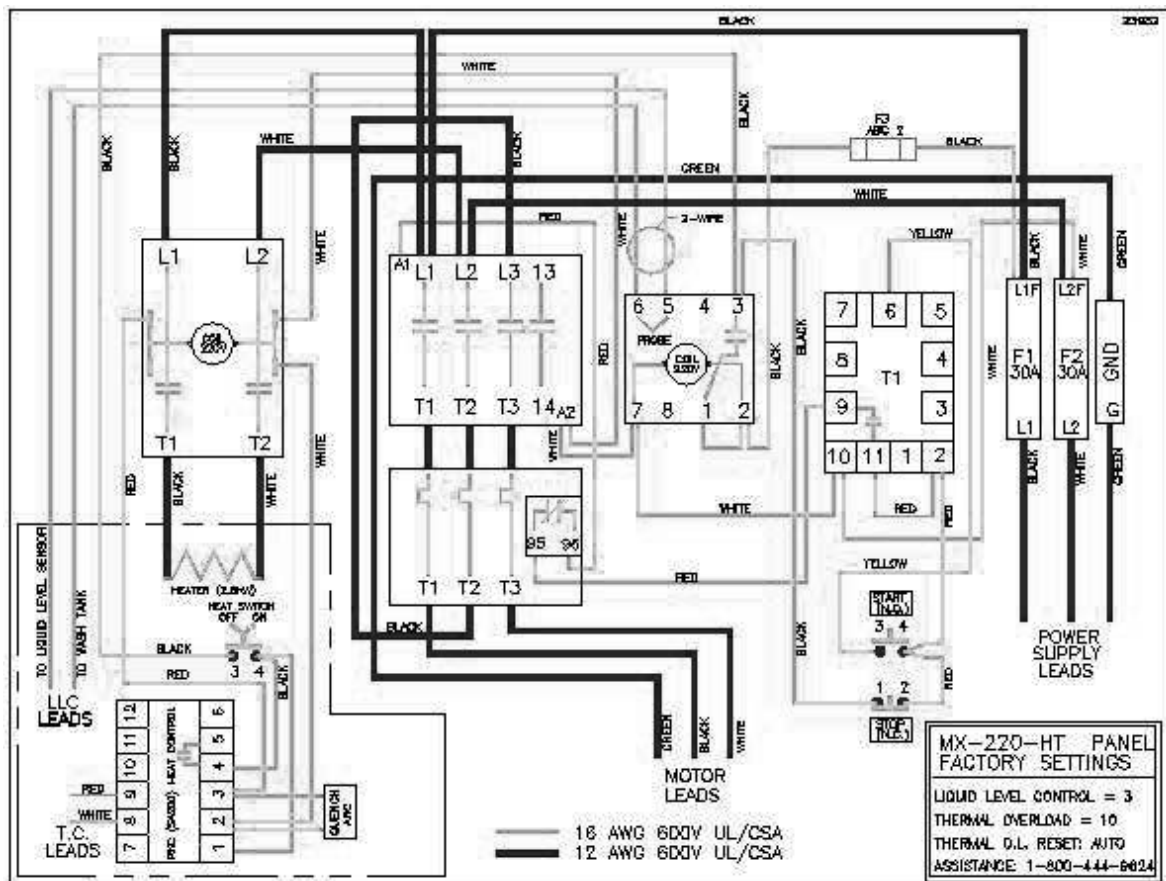

Motor and Pump Assembly

Exploded view

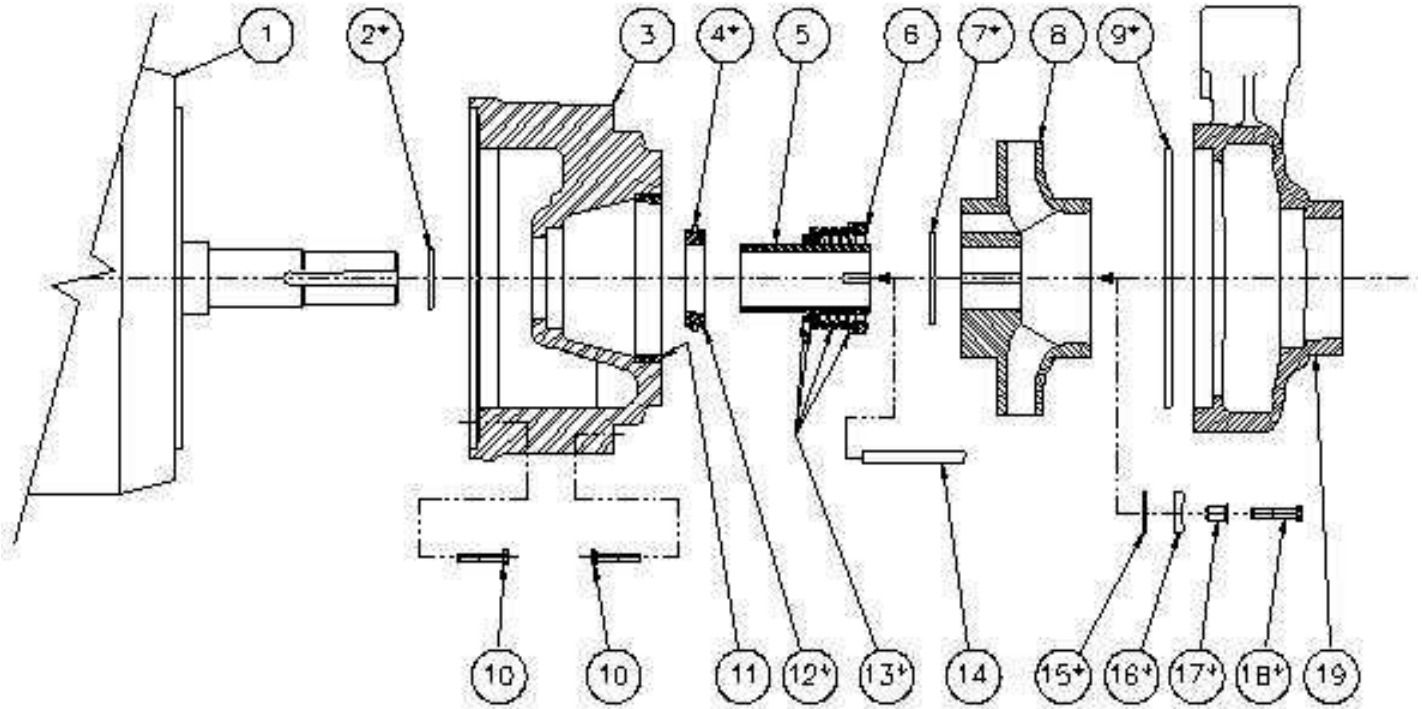

Item	Description
1	Motor, 2 HP, 50 Hz, 1 Ph, 230V
2	* Sleeve O-ring
3	Black adapter with wear ring
4	* Seat O-ring
5	Shaft sleeve
6	Retaining ring
7	* Sleeve gasket
8	Impeller
9	* Casing gasket
10	Screw

Item	Description
11	Adapter ring
12	* Seal seat
13	* Sleeve subassembly
14	Impeller key
15	* Impeller washer gasket
16	* Impeller washer
17	* Impeller screw seal
18	* Impeller screw
19	Casing

* indicates parts included in the seal kit

Motor and Pump Assembly Disassembly Procedure

1. Remove casing cap screws, which hold adapter to casing.
2. Pry adapter from casing with pry bar or large screwdriver and remove adapter and motor from casing.
3. Using a suitable holder to keep impeller from turning, remove impeller cap screw washer and gaskets. Be careful not to damage precision surfaces of impeller.
4. Remove impeller and impeller key from shaft.
5. With impeller and key removed, the shaft sleeve and the mechanical seal assembly can be removed as a unit. Sometimes, the sleeve is difficult to remove due to rust from moisture accumulation. If this is the case, applying heat to the sleeve exterior with a torch and/or a gear puller may help. The heat allows the sleeve to expand. However, too much heat may allow the shaft to expand as well.
6. Remove adapter cap screws, which hold adapter to motor.
7. Remove adapter from motor by prying with pry bar or screwdriver.
8. With adapter removed, the seal and seat ring can be pushed out with the fingers.

Motor and Pump Assembly Inspection and Repair of Components

With pump wet end disassembled, clean all parts and check for worn or damaged areas. It is seldom economical on these pumps to repair damaged or worn parts. Therefore, when a part is found unusable, it should be replaced.

Casing

Clean and inspect gasket surfaces for damaged areas that would cause leaks. Check wearing ring surfaces for excessive wear.

Impeller

Check wearing ring surfaces for excess wear and gasket surfaces of impeller hub for damage. If excessively worn or eroded, the impeller should be replaced.

Adapter

Clean and inspect gasket surfaces. Remove any dirt or scale from mechanical seal cavity. Check adapter ring for wear and excess clearance.

Shaft Sleeve

Check for any damage to gasket surface on impeller end, O-ring groove on motor end, or outside diameter where rubber bellow of mechanical seal contacts.

Mechanical Seal

It is not recommended that the mechanical seal be reused unless the pump has never been run. A mechanical seal is like a gasket in this respect. Using an old one leaves too much chance of failure to make the gamble worthwhile, considering the usual cost of installing and removing a pump from it's system.

Motor or Frame Shaft

Check the shaft for any bent condition by installing the shaft sleeve, clamping a dial indicator to the motor face and reading runout at center of sleeve while turning shaft by hand. Maximum allowable runout is .002 inches for proper performance of mechanical



seal. Anything beyond this will require repairs to the motor, which are beyond the scope of these instructions. Check motor fan and shroud for damage and clean, if necessary.

Motor and Pump Assembly Assembly Procedure

The PowerSoak pumps are easy to put together. The hardest part, requiring the most care, is installation of the mechanical seal parts.

Study the exploded diagram and become familiar with the name of each part. The diagram shows the relative order of assembly, but also **READ THE FOLLOWING INSTRUCTIONS.**

1. **Make sure all of the parts are clean and ready for assembly.** This means no dirt or pieces of old gasket in the joints between the motor, adapter, and casing. Make sure the parts around mechanical seal are clean. Dirt and misalignment will ruin a mechanical seal.
2. **Install the shaft sleeve o-ring in the place against the motor shaft shoulder.** Don't let it be cut by the sharp edges of the keyway.
3. **Push the mechanical seal seat squarely in the adapter.** Use fingers only. A little liquid soap (or light oil if soap not available) can be wiped on the outside of the seat ring to make it slip easily into position. Don't let it be cut by the edges of the adapter. Don't install the adapter on the motor face yet.
4. **Check the shaft sleeve fit on the motor shaft.** It should slide easily into place. If it doesn't, find out why. Do not try to drive the shaft sleeve onto the shaft with a hammer. Check to make sure there are no score marks or scratches on the sleeve.
5. **Install the adapter and tighten the cap screws, which hold it to the motor face.**
6. **Remove any dirt particles and coat the lapped face of the mechanical seal with clean SAE 10 or SAE 20 oil. DO NOT USE GREASE.**
7. **Slide the shaft sleeve on the shaft** so that it covers the shaft sleeve o-ring and butts against the shoulder.
8. **Coat the shaft sleeve lightly with liquid soap** (or light oil if soap not available).



9. Carefully remove any particles from the lapped face of the carbon washer (part of the mechanical seal) and coat it with clean SAE 10 or SAE 20 oil. **DO NOT USE GREASE.**



Motor and Pump Assembly Assembly Procedure - Continued

10. **Install the mechanical seal on the shaft sleeve by hand.** A twisting motion may be needed to make it ride smoothly over the shoulders on the sleeve. Push it by hand until it contacts the seat, make sure the spring and spring holder line up properly. *(see note)
11. **Install the snap ring** using one hand to hold the snap ring pliers and the other hand to compress the spring. When the spring pressure is released, the spring will push the shaft sleeve outward, exposing the shaft sleeve o-ring to view temporarily.
12. **Install the impeller key**, first twisting the shaft sleeve on the shaft until the keyways line up.
13. Install the shaft sleeve gasket.
14. **Place the impeller on the shaft engaging the key.**
15. **Put the impeller screw gasket, impeller washer, and impeller washer gasket together on the impeller screw as an assembly.**
16. **Install the impeller screw subassemblies.** With one hand, push the impeller back against the mechanical seal spring and with the other hand turn the impeller screw in *hand tight*.
17. **Check to see if the shaft sleeve has moved to its final position** covering most of the shaft sleeve o-ring.
18. **Tighten the impeller screw** to 15 ft-lb. torque.
19. **Install the casing gasket** on the shoulder of the adapter.
20. **Install the casing** and tighten all the casing screws.
21. **Turn the motor shaft and check for any bindings or rubs** caused by such things as damaged or mis-aligned parts. Re-check all casing bolts for tightness. Tighten casing bolts one at a time, turning the motor shaft, until rub disappears.

*NOTE

An optional procedure for assembly of the mechanical seal consists of mounting the mechanical seal and the snap ring on the sleeve as a subassembly, which is then placed in position on the motor shaft. Experienced pump mechanics may find that this is more convenient as long as they recognize that this way introduces some additional hazards of damaging or improper assembly of precision seal parts.

Power Soak[®] 

METCRAFT INC.



Installation Guide

The installation and initial operational check of your new system must be performed only by licensed and certified plumbers and electricians.



Be sure to follow all applicable national and local electrical codes when installing the electrical supply and/or a new breaker. **DO NOT** connect the system using a power cord and plug or an extension cord of any kind.



Please refer to the detailed installation instructions that were sent with your *Power Soak* system.

Providing Proper Electrical Service

The requirements of your new system are on the serial number plate located on the front of the wash sink, adjacent to the control panel enclosure and inside the enclosure itself.

All *PowerSoak* systems have a single point electrical connection, and a dedicated circuit is required.



Providing Proper Electrical Service

The system is completely pre-wired and tested at the factory, and a hard-wired connection from an appropriate power source junction box is all that is required.

The installer is to provide a disconnect that should be incorporated in the fixed wiring. Properly sized watertight conduit, fittings and parts are required, as well as the appropriate gauge wire.

If your system is a “left-to-right” unit, you should locate the power source junction box at the left end of the system. (The opposite would be true for a “right-to-left” system.)

Ideally, the junction box should be located on the wall directly behind the pump motor and control panel.

A wiring diagram is located in the system’s control panel enclosure. Specific part numbers and part information can be obtained from the factory by calling **800-444-9624**.

Plumbing Requirements

Your unit requires the following plumbing connections:

- 3/4” (19mm) or 1/2” (12 mm) hot and cold water supply lines.
- One wastewater connection (minimum 1 1/2” / 38mm).



Notes

A series of horizontal lines provided for taking notes.



Power Soak is a registered trademark of Cantrell Industries, Inc.
The Power Soak design and concept is fully patented.

13910 Kessler Drive, Grandview, MO 64030
Phone: (816) 761-3250 Fax: (816) 761-0544
(800) 444-9624
www.powersoak.com

METCRAFT INC.