

Operation Manual



Toaster Grills
Models 247-ACC & 248-BCC

Product Identification

The Prince Castle 247-ACC & 248-BCC Toaster Grill Series offers two practical options for quick-and-easy bread product toasting. Both models have pivoting sides allowing for easy access to the platens for cleaning. The 248-BCC Model has the added feature of a Club sandwich level.



Model 247-ACC



Model 248-BCC

LIMITED WARRANTY

This product is warranted to be free from defects in material and/or workmanship for a period of two (2) years from date of original installation, not to exceed 30 months from date of shipment from our factory. This warranty covers on location service for 2 years (i.e. trip charges and/or mileage). Travel mileage is limited to 100 miles (200 kilometers) round trip (one trip per warranty) from an authorized service agency or its sub-service agency. Any component which proves to be faulty in material and/or workmanship will be replaced or repaired (at the option of Prince Castle, Inc.) without cost to the customer for parts or labor.

This warranty is subject to the following exceptions/conditions:

- Use of any non-genuine Prince Castle parts voids this warranty.
- All labor shall be performed during regular work hours. Overtime premium will be charged to the buyer.
- Damage caused by carelessness, neglect, and/or abuse (e.g., dropping, tampering or altering parts, equipment damaged in shipment, by fire, flood or an act of God) is not covered under this warranty.
- The power cord on this product is rated for a maximum surface temperature of 194°F (90°C). If the cord comes into contact with any heated surface, it may be damaged and/or cause damage to the product and/or injury to the user. Damage resulting from any such misuse may result in a voided Warranty at the sole discretion of the manufacturer.



PRINCE CASTLE INC. 
WORLDWIDE



A Marmon Group / Berkshire Hathaway Company

355 East Kehoe Blvd. • Carol Stream, IL 60188 USA
Telephone: 630-462-8800 • Toll Free: 1-800-PCASTLE
Fax: 630-462-1460 • www.princecastle.com

Table of Contents

Product Identification 1
 Safety Information 2
 Accessories 2
 Installation 3
 Setting the Controls 3
 View/Change Set Temperature 5
 View/Change Set Toasting Time 6
 View/Change Duty Time Alarm 8
 Standby (Energy Saving) Mode 8
 View/Calibrate Platen Temperature 9
 Change Product Name (Product Mode Only) 11
 Set Volume Levels (All Models) 11
 Adjusting Bun Crush Settings 12
 Adjusting for Bun Thickness 12
 Conditioning the Platens 13
 Cleaning 14
 Troubleshooting Guide 15
 Ordering Parts and Service 16
 Model 247-ACC Exploded View 17
 Model 248-BCC Exploded View 18
 Model 247-ACC Wiring Diagram 19
 Model 248-BCC Wiring Diagram 20
 Maintenance Card 21

Safety Information

⚠ WARNING

Indicates information important to the proper operation of the unit. Failure to observe may result in damage to the equipment and/or severe bodily injury or death.

⚠ CAUTION

Indicates information important to the operation of the unit. Failure to observe may result in damage to the equipment.

Accessories

Use standard full-size spatulas with the 247-ACC or 248-BCC Toaster Grills. Also, use the full-size plastic or metal trays under the bottom Platen. You may also use the new nine-bun trays as they become available.

Installation

Remove the unit from the carton and inspect for signs of damage. If there is damage to the unit:

- Notify the carrier within 24 hours of delivery.
- Save carton and packaging materials for inspection purposes.
- Contact your local dealer, or if purchased directly, the Prince Castle Sales Department at 1-800-722-7853 or 630-462-8800 to arrange for a replacement unit.

Before first use, clean and condition the platens (see Conditioning Platens).

NOTE: When using this unit, the ambient temperature at the mounting site should not exceed 43°C (110°F).



All electrical connections must be in accordance with local electrical codes and any other applicable codes. Plug the unit into an applicable electrical receptacle.

Setting the Controls

The model 247-ACC & 248-BCC Toaster Grills provide two modes of operation: **DEDICATED MODE** and **PRODUCT MODE**.

- **DEDICATED MODE** is a simple mode of operation for toasting buns that is similar to the 213, 411 & 416 Series Toaster Grills, with a set toast time and temperature for one product "BUN1".
- **PRODUCT MODE** allows you to set both the toasting time and temperature individually for four additional products. Note that it may take several minutes for the platen to heat up or cool down to a new temperature setting. You can also change the display to any four character name of your choice for each of the products to indicate which product is being toasted.



UP Arrow
DOWN Arrow
TEMPERATURE Button
TIME Button

- Furthermore, 247-ACC and 248-BCC Toaster Grills allow you to manually initiate the power-saving mode. (See **Figure 1**.)

1 When the Toaster Grill is in **Dedicated Mode**:
Press and release both the **UP** and **DOWN** arrows at the same time. This will change the Toaster Grill to Product Mode. Products 1 through 4 will be available.

2 When the Toaster Grill is in **Product Mode**:
Press and release both the **UP** and **DOWN** arrows at the same time. This will change the Toaster Grill to Dedicated Mode. BUN1 will be the only product available.

NOTE: While the unit is adjusting to the new set temperature, the product name flashes in the display. In the Dedicated Mode this is "BUN1". In the Product Mode, the name will be the currently selected product.

When the unit reaches set temperature, the product's name is displayed steadily in Product Mode, or the display shows "RDY" in Dedicated Mode.

The adjustment time necessary will depend on the set temperature.

Product Selection (Product Mode Only)

Press and release any of the four numbered buttons (i.e., 1, 2, 3 or 4) to select the product associated with that button. (See **Figure 2**.)

The LED above the selected Product button glows steady green to indicate the current selection and the display will show the selected product's name.

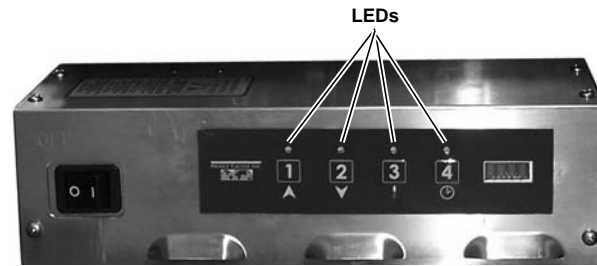

Figure 2

Ready-to-Toast Indication

While the unit is warming up, a product name flashes in the display. In the Dedicated Mode this is "BUN1". In the Product Mode, the name will be the currently selected product. (See **Figure 3**.)

When the unit reaches set temperature, the product's name is displayed steadily in Product Mode, or the display shows "RDY" in Dedicated Mode.



Figure 3

Temperature Mode (F/C) Display Selection

TEMPERATURE MODE: To toggle between Fahrenheit (F) and Celsius (C), at power-on immediately press and release button 3 within 3 seconds. (See **Figure 4**.)

If the unit was set to display temperatures in "C", it changes to display in "F", and vice versa. The display shows "F" or "C" to indicate which mode has been selected. Repeat within 3 seconds to change the display again.

The default Temperature Mode is Celsius.



Press Button 3

Figure 4

Resetting to Factory Presets

To reset all settings to factory presets, at power-on immediately (within 3 seconds) press and hold the **LOGO**, **UP** and **DOWN** buttons simultaneously until the display shows "PSET". Release all buttons. After about 10 seconds, the unit will operate with factory preset temperature, time and display name values. (See **Figure 5**.)
 All previously saved settings are lost upon resetting the defaults.

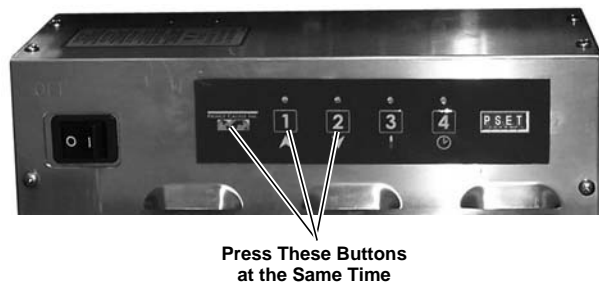

Figure 5

View/Change Set Temperature

To View the Current Set Temperature

In Product Mode:

Press and hold the currently selected product's button and immediately press the **TEMPERATURE** button. Release both buttons.
 The display will show the pre-set toasting temperature for the selected product. (See **Figure 6**.)

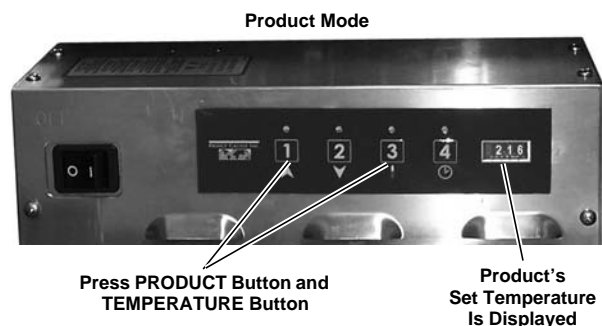

Figure 6

In Dedicated Mode:

Press and release the **TEMPERATURE** button. The display will show the pre-set toasting temperature for "BUN1". (See **Figure 7**.)

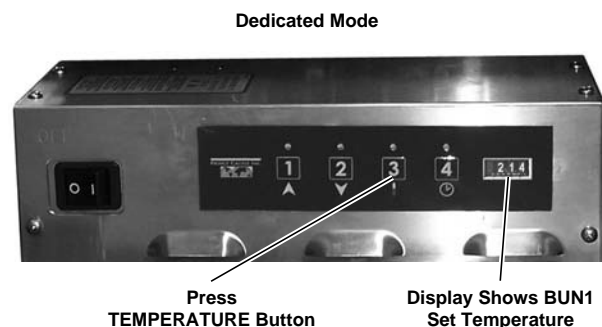

Figure 7

To Change the Set Temperature

- 1 Press the button(s) used to view the set temperature. Hold the button(s) for 6 seconds.

The LED above the **TEMPERATURE** button will flash yellow, indicating that the unit is now in set-temperature programming mode. Release all buttons.

- 2 Press and release the **UP** or **DOWN** buttons to change the currently selected product's toasting temperature. Holding either button for 3 seconds will allow automatic "fast scrolling" for easier programming.

The temperature can be set from 37°C to 287°C (100°F to 550°F).

- 3 When finished, press and release the **TIME** button to save the new value and return to toasting.

Press and release the **LOGO** button at any time to exit the programming mode without saving any changes made.

NOTE: While the unit is adjusting to the new set temperature, the product name flashes in the display. In the Dedicated Mode this is "BUN1". In the Product Mode, the name will be the currently selected product.

When the unit reaches set temperature, the product's name is displayed steadily in Product Mode, or the display shows "RDY" in Dedicated Mode.

The adjustment time necessary will depend on the set temperature.



Figure 8

LOGO Button

View/Change Set Toasting Time

To View the Set Toasting Time

In Product Mode:

Press and Hold the currently selected product's button and immediately press the **TIME** button. Release both buttons. The display will show the present toasting time for the selected product. (See **Figure 9**.)

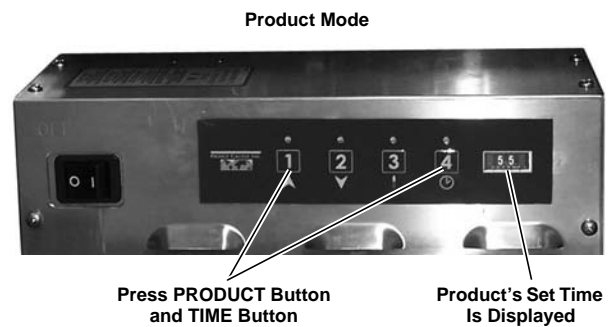

Figure 9

In Dedicated Mode:

Press and release the **TIME** button. The display will show the present toasting time for "BUN1".

In either mode, after 3 seconds the display will return to showing the currently selected product time. (See **Figure 10**.)

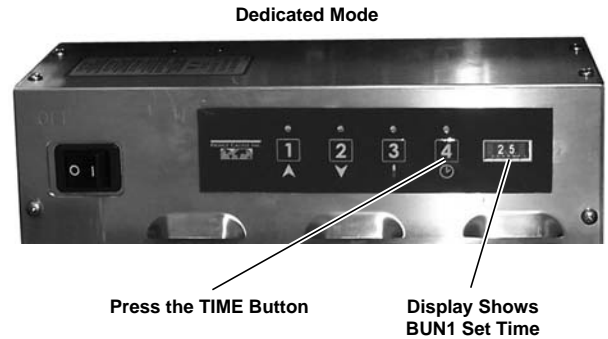

Figure 10

To Change the Set Toasting Time

- 1 To change the toasting time of the currently selected product, press the same button(s) used to view the toasting time. Hold the button(s) for 6 seconds.

The LED above the **TIME** button will flash yellow, indicating that the unit is now in set-time programming mode. Release all buttons.

- 2 Press and release the **UP** or **DOWN** buttons to change the currently selected product's toasting time. Holding either button for 3 seconds will allow automatic "fast scrolling" for easier programming.

The time can be set from 1 sec. to 9 minutes, 59 seconds.

- 3 When finished, press and release the **TIME** button to save the new value and return to toasting.

Press and release the **LOGO** button at any time to exit the programming mode without saving any changes. (See **Figure 11**.)



Figure 11

LOGO Button

View/Change Duty Time Alarm

- 1 A. Press and hold the **LOGO** button. Immediately press the **TIME** button.
B. Release all buttons. The display will show the present duty time for "BUN1" in **Dedicated Mode** and for whichever product is selected in **Product Mode**.

- 3 Press and release the **UP** or **DOWN** buttons to change the currently selected product's duty time.
When finished, press and release the **TIME** button to save the new value and return to toasting.

- 2 To change the duty time of the currently selected product, press and hold the buttons in Step 1 for 6 seconds.
The LEDs above the **TIME** and **UP** Arrow button will flash yellow, indicating that the unit is now in the duty time programming mode.

To exit the programming mode without saving any changes, press and release the **LOGO** button.
NOTE: The duty time may be set to OFF or 15–20 seconds. If not off, the duty alarm will sound the programmed number of seconds after toasting is started.

Standby (Energy Saving) Mode

- 1 **Direct Method:** To place the unit in Standby Mode, close the platen and press and hold the **UP** and **DOWN** buttons together for 3 seconds. The unit will stop timing and the display will indicate "STBY". Open the platen to cancel Standby mode. (See **Figure 12**.)

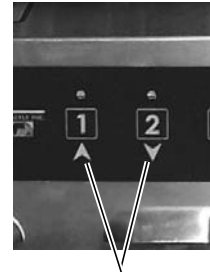

UP and DOWN Arrows

Figure 12

- 2 **After Toasting:** After toasting is complete, the Done Alarm will sound for 7 seconds. If the platen is left closed, the Toaster Grill will automatically enter the Standby Mode and the display will read "STBY". Open the Toaster Grill to reactivate it from Standby Mode. (See **Figure 13**.)



Figure 13

View/Calibrate Platen Temperature

Important!

Do NOT perform this procedure until the Toaster Grill has been on for at least 45 mins. and the temperature has stabilized. Do NOT use the Toaster Grill during the first 45 minutes.
Temperature can only be adjusted $\pm 10^{\circ}\text{C}$ ($\pm 18^{\circ}\text{F}$) during calibration.

Important!

If the temperature reading from the external temperature port is greater than $\pm 3^{\circ}\text{C}$ ($\pm 5^{\circ}\text{F}$) compared to the Toaster Grill temperature display, proceed with the following. If temperature reading is within $\pm 3^{\circ}\text{C}$ ($\pm 5^{\circ}\text{F}$), the Toaster Grill is functioning properly and does not need calibration.

Upper Platen (248-BCC Models Only)

- 1** A. Plug an external temperature meter into the external port (Type K mini-jack) of the heater platen.
 B. Using the external temperature meter as a standard, adjust the Toaster Grill's temperature display to match the meter's temperature display by the following procedure.

NOTE: Yellow Type K Thermocouple mini-jack temperature ports are located on the back of the 248-BCC Model, behind each of the two platens. (See Figure 14.)

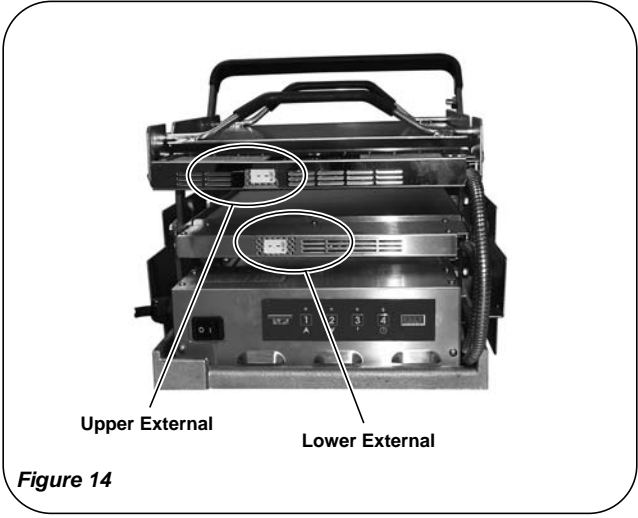

Figure 14

- 2** A. To view and/or calibrate the platen temperature, press and hold the **LOGO** button.
 B. Immediately press the **UP** button to view the Upper Platen temperature on 248-BCC Models.
 C. Release both buttons. (See Figure 15.)
 The display shows the Upper Platen's temperature. After 3 seconds, the display returns to showing the currently selected product.

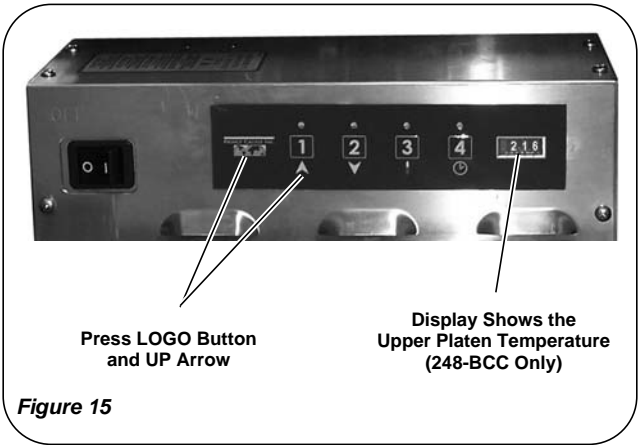

Figure 15

Toaster Grills

Models 247-ACC & 248-BCC

3 To calibrate the Upper Platen, press and hold the **LOGO** and **UP** buttons, as in Step 2, but continue holding them for 6 seconds.

The LEDs above to buttons **1** & **3** flash, indicating that the unit is now in Upper Platen temperature calibration mode.

Release all buttons.

4 To change the Upper Platen's displayed temperature, press and release button **UP** or **DOWN** Arrow.

After changing the value, be sure to wait for the display to show the temperature change.

5 To save the new value and return to toasting, press and release button **4**.

To exit programming without saving any changes made, press and release the **LOGO** button.

Lower Platen (All Models)

1 A. Plug an external temperature meter into the external port of the heater platen.
B. Using the external temperature meter as a standard, adjust the Toaster Grill's temperature display to match the meter's temperature display, by the following procedure.

2 A. To view the Lower Platen's temperature, press and hold the **LOGO** button.
B. Immediately press the **DOWN** button. Release all buttons.

The display shows the Lower Platen's temperature. After 3 seconds, the display returns to showing the currently selected product. (See **Figure 16**.)

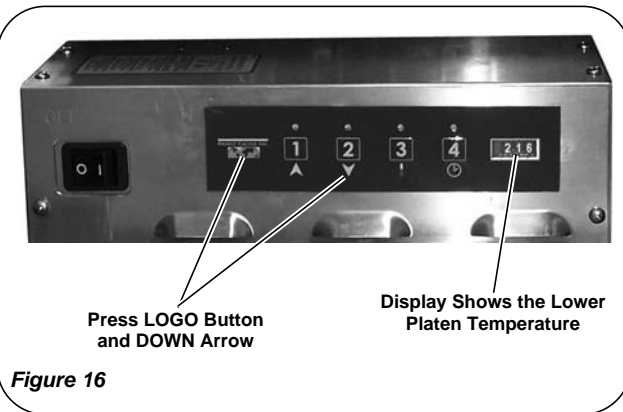

3 To calibrate the Lower Platen, press and hold the **LOGO** button and **DOWN** arrow, as in Step 2, but continue holding them for 6 seconds.

The LEDs above buttons **2** & **3** flash, indicating that the unit is now in Lower Platen temperature calibration mode.

Release all buttons.

*NOTE: A yellow temperature port is located on the back of the 247-ACC Model, behind the platen (same as the Lower External Port in on 248-BCC Model figure above). (See **Figure 14**.)*

4 To change the Lower Platen's displayed temperature, press and release **UP** or **DOWN** arrows.
After changing the value, be sure to wait for the display to show the temperature change.

5 When finished, press and release button **4** to save the new value and return to toasting.
To exit programming without saving any changes made, press and release the **LOGO** button.

Change Product Name (Product Mode Only)

- 1** Place the Toaster Grill in **PRODUCT MODE** (refer to "Mode Selection").
Press one of the four numbered buttons (i.e., **1, 2, 3** or **4**) to select the product name you wish to change.
- 2** Press and hold the **LOGO** button and button **3** for 6 seconds.
The LED next to the currently selected Product flashes and the first character of its displayed name blinks.
- 3** A. Use **UP** or **DOWN** arrows to scroll through the available characters for the display.
B. Hold either button for 3 seconds to allow automatic "fast scrolling" for easier programming.
- 4** When the desired character is displayed in the first position, release the **UP** or **DOWN** arrow, and press and release button **3** to move on to the second display character.
- 5** A. Repeat steps 3 & 4 to program each character as desired.
B. When in the fourth position, press and release button **3** to return to the first display character.
- 6** When the display name is changed as desired, press and release button **4** to save it.
To exit programming without saving any changes made, press and release the **LOGO** button.

Set Volume Levels (All Models)

- 1** To view the current volume level, press and hold the **LOGO** button. Immediately press and hold the **TIME** button and **TEMPERATURE** button to view the present Volume Level.
Release all buttons.
The display will return to showing the currently selected product.
- 2** To change the volume level, press and hold the buttons in Step 1 for 6 seconds. The display will continue to show Volume Level and a tone will sound indicating that the unit is now in Volume Setting Mode.
- 3** Press and release the **UP** or **DOWN** arrows to adjust the volume level.
When finished, press and release the **TIME** button to save the new value and return to toasting.

Adjusting Bun Crush Settings

To adjust the bun crush settings, use the knob located on the front of the unit's base. There are 10 incremental settings, each increasing the center gap by approximately 2 mm. (See **Figure 17**.)

- To set the thickness from 1 to 5, lift and slide the knob to the left-most position. Then, rotate the knob until the desired setting is in the "window".
- To set the thickness from 6 to 10, lift and slide the knob to the right-most position. Then, rotate the knob, until the desired setting is in the "window".

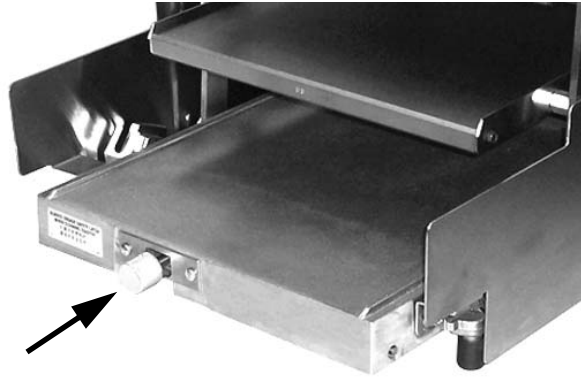

Figure 17

Adjusting for Bun Thickness

The 248-BCC model has two sets of notches in the side bun fences. (See **Figure 18**.)

- Put the bun board in the front, lower notches for REG or QTR buns.
- Use the rear, upper notches for MAC or RIB buns.

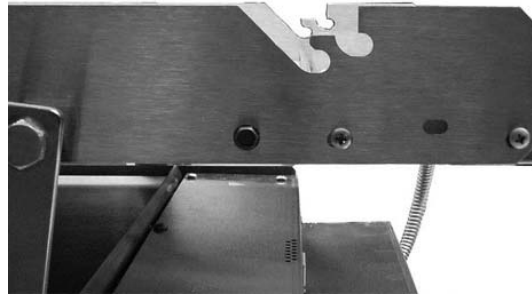

Figure 18

Conditioning the Platens

- 1** To minimize bun-sticking, the platens should be wiped weekly with McD Bun Toaster Grill Release Agent.

 **CAUTION**

Use only McD Bun Toaster Grill Release Agent on bun Toaster Grills. Other products may cause damage and void the Warranty.

- A. Dust all loose crumbs from Toaster Grill surfaces.
- B. Apply McD Bun Toaster Grill Release Agent to cool or warm Toaster Grill platens.

- 2** To coat the platen surface, thoroughly wet a clean, folded customer napkin or paper towel with Toaster Grill Release Agent, and place it on No. 257 cleaning tool.

- 3** A. Rub a generous amount of the Release Agent over the entire surface of the platen until well coated.
B. Repeat Steps 2 & 3 for other platens, including undersides.

 **WARNING**

BURN HAZARD! Use protective gloves and No. 257 cleaning tool when conditioning hot platens.

IMPORTANT! Do NOT wipe Toaster Grill with a damp cloth after Release Agent is applied. Doing so removes Agent and causes sticking.

Toaster Grill platens must be clean and dry.

- 4** Reapply Release Agent weekly to all platen surfaces while Toaster Grill is cold.
If sticking occurs between weekly applications, reapply Release Agent more frequently as described in Steps 1 – 3.

Cleaning

- A. Periodically and upon shutdown, use a clean, dry soft cloth to wipe down the Toaster Grill unit.

B. When the platens are cool, you may also use a mild soap solution on a damp soft cloth to remove stubborn food remains, if necessary.

Do NOT use any unapproved agents or cleaning solutions inside or on surfaces of Toaster Grill unit. Such misuse could void the warranty.

 **WARNING**

Do Not Clean with Water Jet.

- Remove the side covers, as shown, for further cleaning. (See **Figure 19**.)

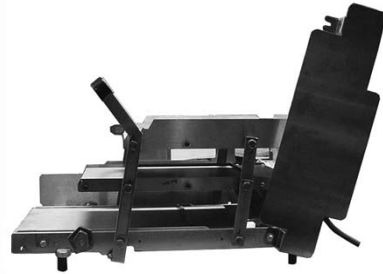

Figure 19

- Replace side covers when finished. (See **Figure 20**.)



Figure 20

Troubleshooting Guide

⚠ WARNING
SHOCK HAZARD! Live circuits are exposed! Use extreme care during electrical circuit tests. Do NOT attempt any troubleshooting without proper authorization to do so.

⚠ WARNING
Inspection, testing and repair of electrical equipment are to be performed by qualified service personnel ONLY. Unplug unit during testing, except as electrical tests are required.

PROBLEM	PROBABLE CAUSE	SOLUTION
Platen loose.	Platen bolts loose.	Tighten platen bolts.
	Worn bearings.	Replace worn bearings.
No alarm.	Defective timer switch.	Replace timer switch.
	Activation magnet is missing.	Two magnets are required.
Buns being crushed.	Stop blocks not adjusted properly.	Adjust stop blocks.
	Warped bun trays.	Straighten or replace bun trays.
	Buns cut improperly.	Contact bakery.
	Warped bun board.	Straighten or replace bun board.
Platen does not heat.	No power.	Check power source.
	Power switch defective.	Replace power switch.
	Loose wiring.	Correct as necessary.
	Defective temperature probe.	Replace temperature probe.
	Platen burned out or shorted.	Replace platen; call Service Agency.
Buns sticking to platen.	Excessive heat due to reversed upper and lower temperature probe connections.	Reverse connections of upper and lower temperature probe connections in electrical box.
	Build up of sugar on platen.	Clean platen.
Cold platen.	Loose electrical connection.	Reconnect wires from solid-state relay to printed circuit boards.

Ordering Parts and Service

To Order Replacement Parts or Service —

INTERNATIONAL: Contact your Kitchen Equipment Supplier or designated repair facility for parts and service.

Exploded Views

Parts Breakdown

No.	Part No.	Description
1	248-141S	Overlay Kit *
2	248-140S	Display Printed Circuit Board Kit *
3	66-017S	Strain Relief Kit *
4	248-151S	Stop Block Kit
6	411-60S	Lower Platen Stud (Pkg. of 2)
7	411-113S	Base Spacer (Pkg. of 7)
9	248-018S	Lower Platen Fence Kit, RH & LH *
10	411-461S	Rear Upper Lever Assembly *
11	411-459S	Rear Lower Lever Assembly
12	248-044S	Side Panel Kit, LH *
13	248-109S	Side Panel Kit, RH *
14	65-058S	Relay
15	66-045S	Strain Relief
16	78-196S	Switch Kit
17	411-61S	Lower Platen Stud (Pkg. of 2) *
18	411-57S	Platen Spacer (Pkg. of 2) *
19	411-221S	Spacer Kit (Pkg. of 4)
20	248-099S	Base Spacer Kit (Pkg. of 2) *
21	411-147S	Upper Platen Stud (Pkg. of 2)

* Not shown.

No.	Part No.	Description
22	248-048S	Safety Latch Kit *
23	248-202S	Knob Kit
24	248-045S	Rear Bun Fence Kit
25	72-416S	Power Cord Kit - 247-A & 248-B
26	88-497S	Mini Jack, Type K
27	89-959S	Rubber Foot (Pkg. of 4)
28	248-095S	Temperature Probe
29	248-038S	Bun Board for 248 *
30	248-079S	Reed Switch Kit
31	248-067S	Main Printed Circuit Board Assembly
32	248-111S	Upper Bun Fences Kit *
33	248-090S	Lower Platen Kit
34	248-091S	Upper Platen Kit *
35	247-006S	LH Bun Fence Assembly
36	247-004S	RH Bun Fence Assembly
37	411-347S	Replacement Stud Kit
38	247-001	Safety Latch Kit
39	247-032S	Front Lever Assembly for 247
40	411-241S	Safety Latch Spacer (Pkg. of 2)
41	247-014S	Bun Board for 247

* Not shown.

Model 247-ACC

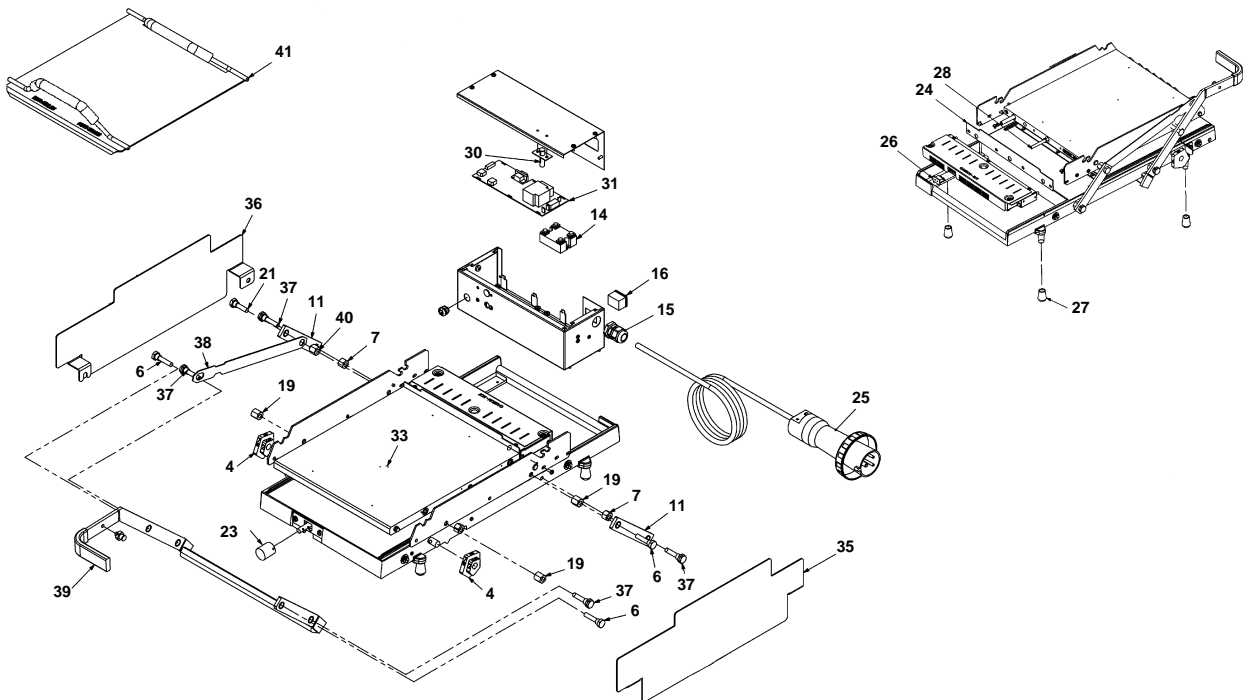

Toaster Grills

Models 247-ACC & 248-BCC

Parts Breakdown

No.	Part No.	Description
1	248-141S	Overlay Kit *
2	248-140S	Display Printed Circuit Board Kit *
3	66-017S	Strain Relief Kit *
4	248-151S	Stop Block Kit
6	411-60S	Lower Platen Stud (Pkg. of 2)
7	411-113S	Base Spacer (Pkg. of 7)
9	248-018S	Lower Platen Fence Kit, RH & LH
10	411-461S	Rear Upper Lever Assembly
11	411-459S	Rear Lower Lever Assembly
12	248-044S	Side Panel Kit, LH
13	248-109S	Side Panel Kit, RH
14	65-058S	Relay
15	66-045S	Strain Relief
16	78-196S	Switch Kit
17	411-61S	Lower Platen Stud (Pkg. of 2)
18	411-57S	Platen Spacer (Pkg. of 2)
19	411-221S	Spacer Kit (Pkg. of 4)
20	248-099S	Base Spacer Kit (Pkg. of 2) *
21	411-147S	Upper Platen Stud (Pkg. of 2)
22	248-048S	Safety Latch Kit

No.	Part No.	Description
23	248-202S	Knob Kit
24	248-045S	Rear Bun Fence Kit
25	72-416S	Power Cord Kit
26	88-497S	Mini Jack, Type K
27	89-959S	Rubber Foot (Pkg. of 4) – 247-A & 248-B
28	248-095S	Temperature Probe
29	248-038S	Bun Board for 248
30	248-079S	Reed Switch Kit
31	248-067S	Main Printed Circuit Board Assembly
32	248-111S	Upper Bun Fences Kit
33	248-090S	Lower Platen Kit
34	248-091S	Upper Platen Kit
35	247-006S	LH Bun Fence Assembly *
36	247-004S	RH Bun Fence Assembly *
37	411-347S	Replacement Stud Kit *
38	247-001	Safety Latch Kit *
40	411-241S	Safety Latch Spacer (Pkg. of 2) *
41	247-014S	Bun Board for 247 *
42	411-149S	Front Lever Assembly for 248

* Not shown.

* Not shown.

Model 248-BCC

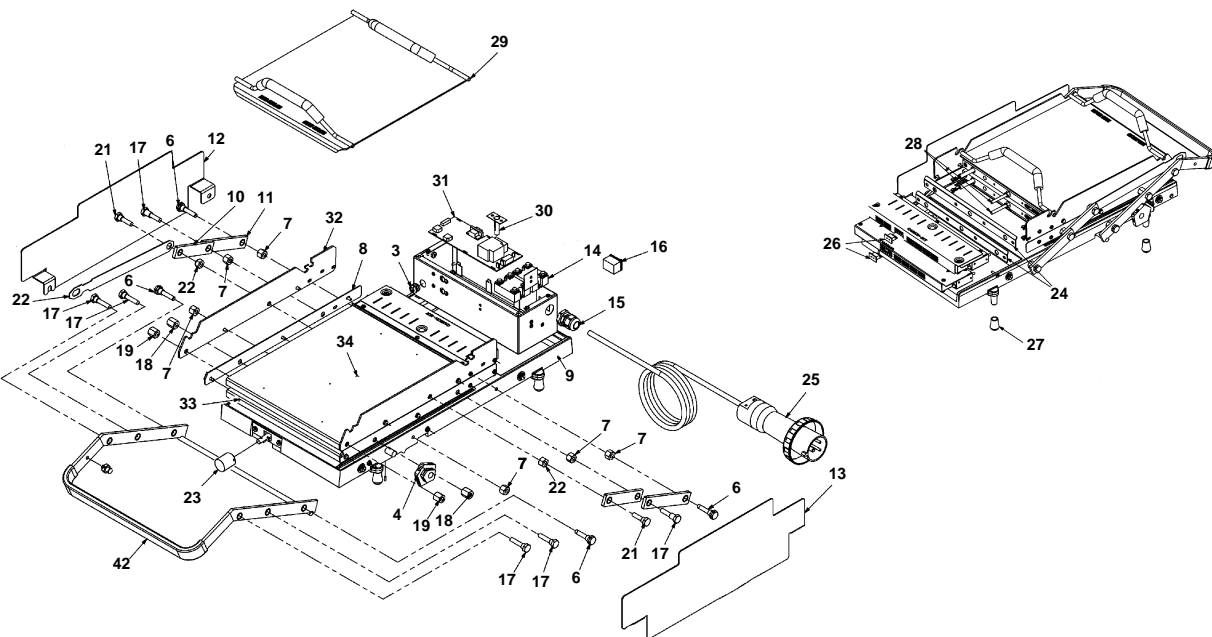

Wiring Diagrams

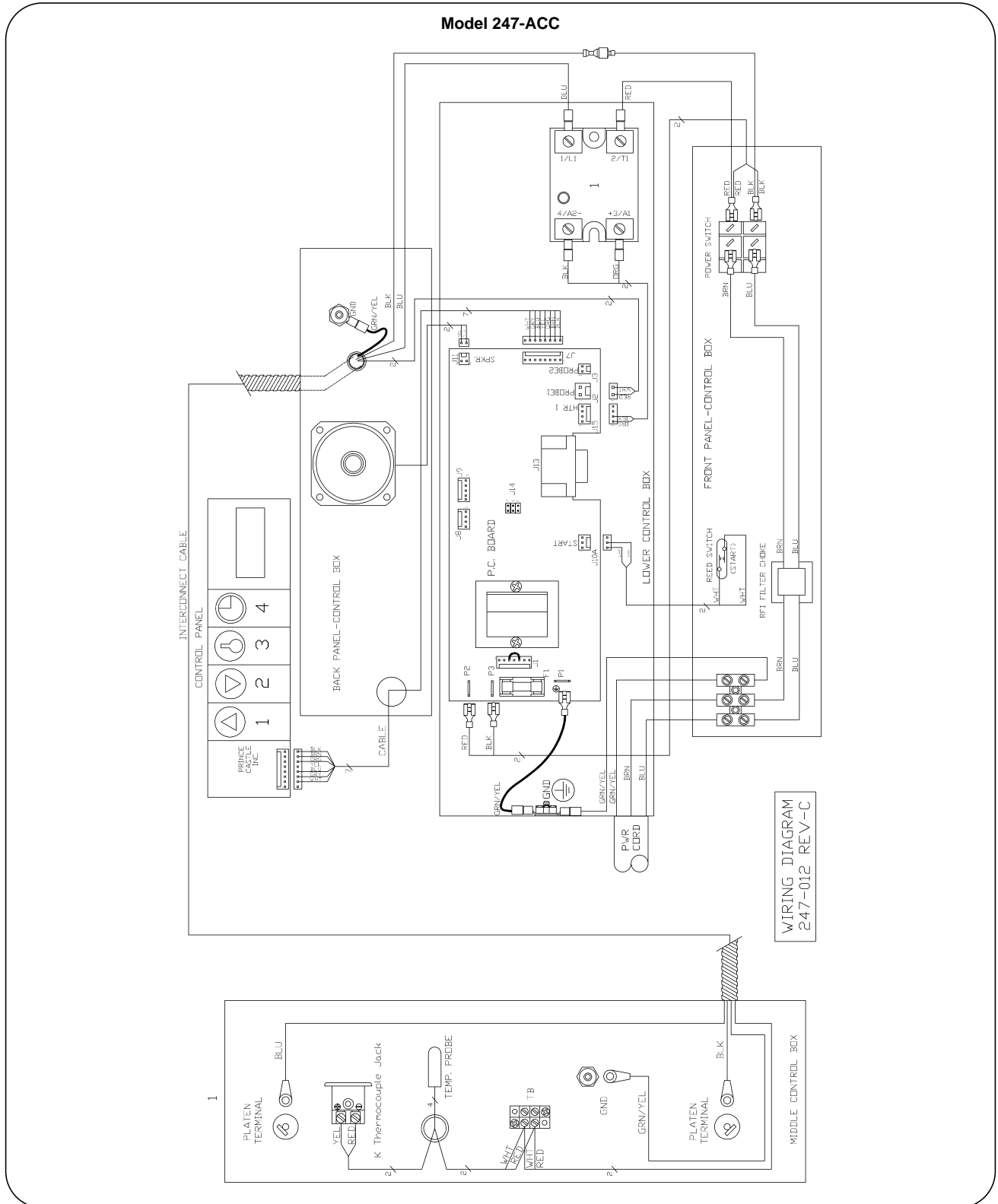

Toaster Grills

Models 247-ACC & 248-BCC

Model 248-BCC

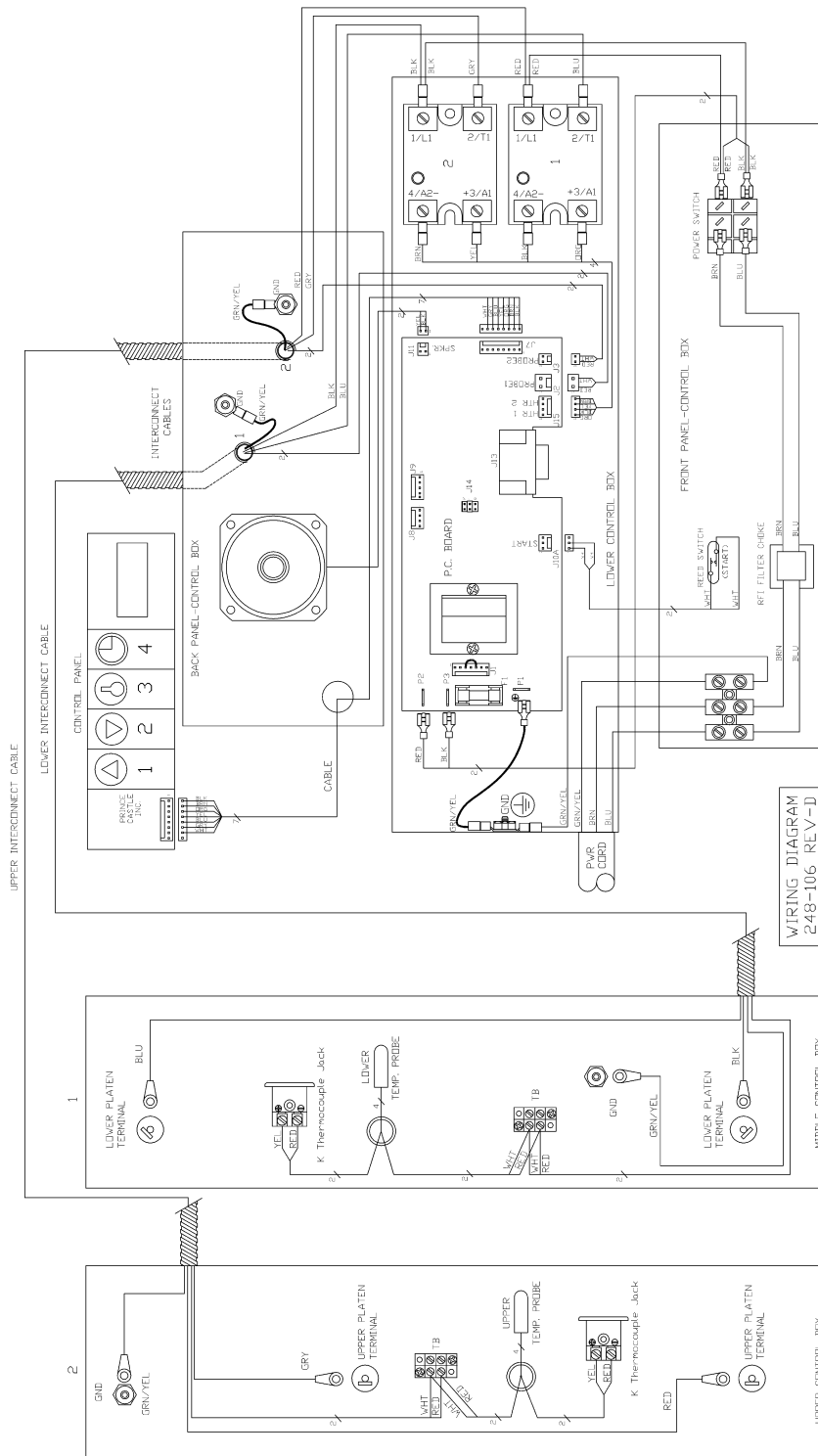

WIRING DIAGRAM
248-106 REV-D