

OPERATING INSTRUCTIONS

Series Solid State Universal Bun Toaster Model No. 411-MSL Series

Excalibur[®]



Model 411-MSL Series Solid State Universal Bun Toasters include the latest enhancements to produce perfectly caramelized buns. The digital readout continuously displays the actual temperatures of the platens throughout operation. Now with long-life, reliable solid state temperature controls, the 411-MSL Series Toaster maintains a much tighter temperature swing resulting in more consistent color, texture and internal bun temperature. Simple to use controls allow the operator to adjust the set point temperature by one degree increments and adjust the toasting cycle by one second increments. Calibration is made easy via the calibration mode and the time/temp readout.

TABLE OF CONTENTS	PAGE
Side View	2
Front View	3
Rear View	3
Internal View	4
Equipment Set-up	5
Programming	6
Cleaning	8
Troubleshooting	8
Diagnostic Troubleshooting	9-11
Wiring Diagram	11

LIMITED WARRANTY

This product is warranted to be free from defects in material and/or workmanship for a period of two (2) years from date of original installation, not to exceed 30 months from date of shipment from our factory. Platens and P.C. Boards are warranted for (3) years not to exceed 42 months from date of shipment from the factory.

Any component which proves to be faulty in material and/or workmanship will be replaced or repaired (at the option of Prince Castle, Inc.) without cost to the customer for parts or labor.

This warranty is subject to the following exceptions/conditions:

- Use of any non-genuine Prince Castle parts voids this warranty.
- This equipment is portable; charges for on-location service (e.g., trip charges, mileage) are only included in the provisions of this warranty for 30 days from original installation.
- All labor shall be performed during regular work hours. Overtime premium will be charged to the buyer.
- All problems due to operation at voltages other than specified on equipment nameplates do not apply to warranty. Conversion to correct voltage must be the customers responsibility.
- Damage caused by carelessness, neglect, and/or abuse (e.g., dropping, tampering or altering parts), equipment damaged in shipment, by fire, flood or an act of God is not covered under this warranty.

PRINCE CASTLE INC. 

355 East Kehoe Blvd • Carol Stream, IL 60188

Tel: (630) 462-8800 • Fax: (630) 462-1460

Toll Free: 1-800-PCASTLE

SIDE VIEW

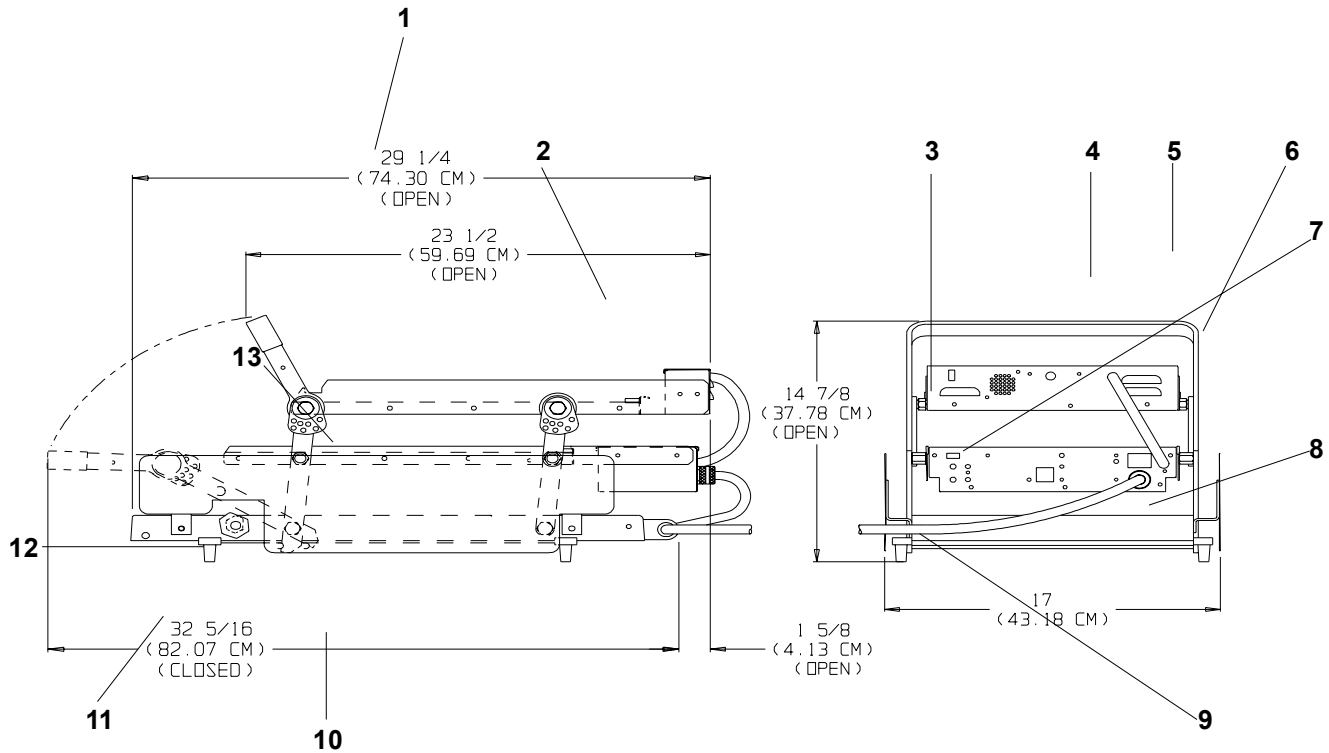

PARTS LIST

ITEM	PART NUMBER	DESCRIPTION
1	411-149S	Handle and Lever Assy.
2	411-376	Right Hand Upper Bun Fence
	411-377	Left Hand Upper Bun Fence
3	411-151S	Upper Rear Lever Assy.
4	411-378	Upper Rear Bun Fence
5	411-31	Upper Cover
6	411-283	Upper Chassis
7	411-381	Lower Rear Bun Fence
8	411-741	Lower Chassis
9	411-64S	Lower Rear Lever Assy.
10	410-002	Right Hand Stop Block
	410-003	Left Hand Stop Block
11	411-2S	Base
12	411-444	Side Panel, Right Hand for MSLF or MSLFCE Series
	411-445	Side Panel, Left Hand for MSLF or MSLFCE Series
	411-728	Side Panels for 411-MSLF Series
13	411-379	Right Hand Lower Bun Fence
	411-380	Left Hand Lower Bun Fence
Not Shown	411-114	Safety Latch
Not Shown	411-183	Bun Board

FRONT VIEW

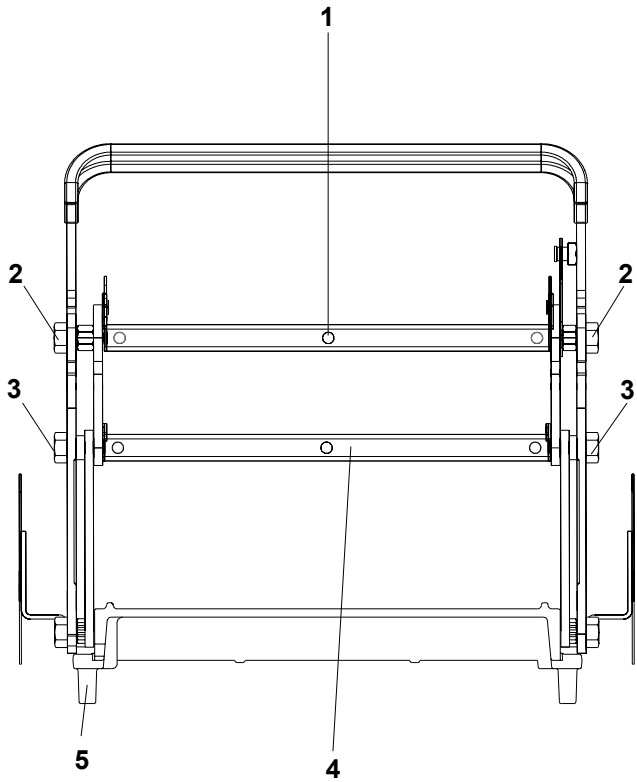

PARTS LIST

ITEM	PART NUMBER	DESCRIPTION
1	411-6S 411-24S	Upper Platen 120V Upper Platen 230V
2	411-60	Front Upper Platen Stud
3	411-60	Front Lower Platen Stud
4	411-8S 411-26S	Lower Platen 120V Lower Platen 230V
5	89-959S	Foot (Pkg. of 4)

REAR VIEW

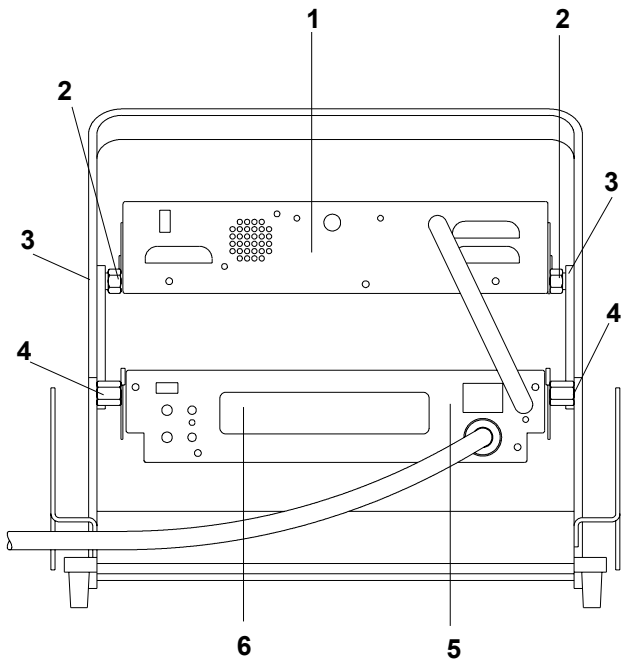

PARTS LIST

ITEM	PART NUMBER	DESCRIPTION
1	411-712	Upper Faceplate
2	411-57	Platen Spacer
3	411-147	Rear Upper Platen Stud
4	411-61	Rear Lower Platen Stud
5	411-705	Lower Faceplate
6	411-707	Overlay

INTERNAL VIEW UPPER CONTROL BOX

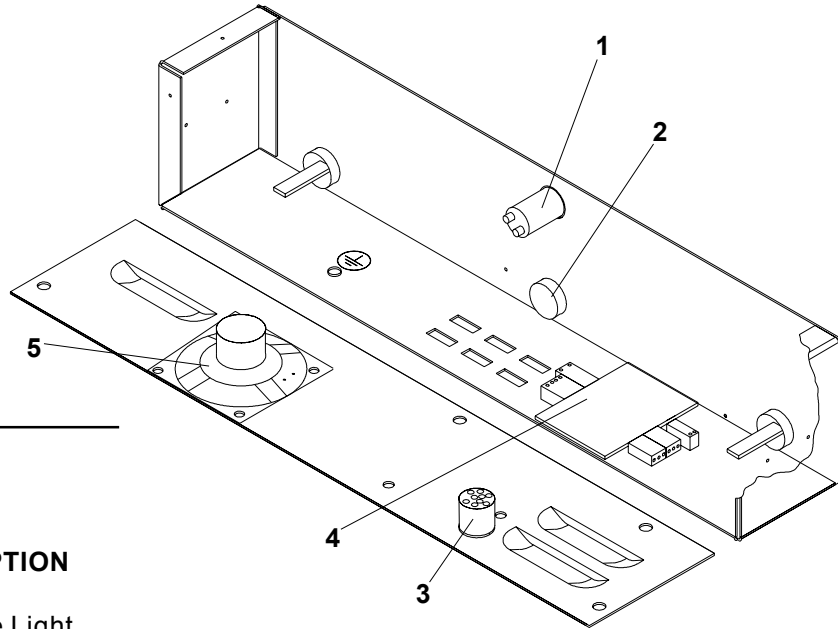

PARTS LIST

ITEM	PART NUMBER	DESCRIPTION
1	213-257S	Bun Done Light
2	411-700S	Upper Probe
3	411-740	Interconnect Cable
4	411-14S	Interconnect Board
5	735-61\$	Speaker

INTERNAL VIEW LOWER CONTROL BOX

PARTS LIST

ITEM	PART NUMBER	DESCRIPTION
1	65-053-04S	Relay
2	411-700S	Probe
3	65-039S	Relay
4	72-285	Power Cord w/plug 220-230V for 411-MSLF
	72-273	Power Cord w/Twist Lock Plug for 411-MSL
	72-196S	Power Cord w/plug for MSLFACE
5	78-166S	Rocker Switch
6	411-426S	Control Display P.C. Board, 120V
	411-427S	Control Display P.C. Board, 200-230V

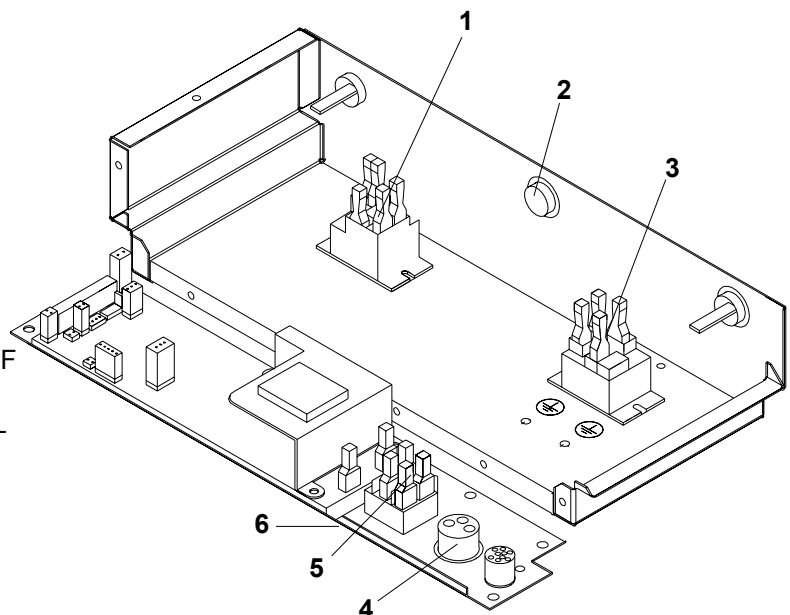

SYMBOLS & TERMS

C - - A Toaster is set on Celsius.

F - - A Toaster is set on Fahrenheit.

A L - Alarm Level setting 1-4.



Sound Button: Used with timer button and temperature button to set alarm level.



Timer Button: Used to view time in run mode. Used to set time in program mode.



Temperature Button: Used to view set point temperature in run mode, and used to set the set point temperature in program mode.



Up Arrow: Used to set time, sound and temperature in program mode.



Down Arrow: Used to set time, sound, and temperature in program mode.

FACTORY PRE-SET

Prince Castle's Solid State Digital Display toasters are pre-set at the factory.

If your toaster model is set for a 35 second toast time, then the temperature is pre-set and calibrated to 420°C.

If your toaster model is set for a 55 second toast time, then the temperature is pre-set and calibrated to 400°C.

SET-UP

1. Refer to the nameplate on the control box for the proper operating voltage. Connect the toaster to a grounded receptacle that matches the nameplate voltage information. Press the power switch to the on position, allow the unit 30 minutes to reach operating temperature.
2. The toaster is factory-set to display temperatures reading in Fahrenheit. When the toaster is turned on, the digital display on the control box will read F--A for Celsius, and the "A" will begin to count down 9 seconds. During this countdown, you can change the temperature display from Celsius to Fahrenheit readings. To change temperature display, press and hold the temperature button for six seconds. See figure 1.

figure 1

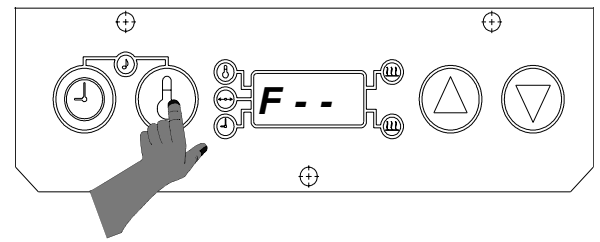

3. During the pre-heat cycle, the display will read - L O -. When the platen temperature reaches 300° F (149° C), the display will begin to show the actual platen temperatures throughout the toasting cycles. See figure 2.

figure 2

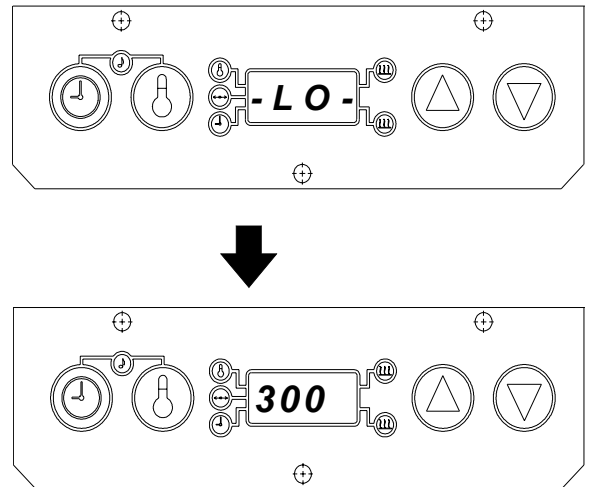

Sound Level Adjustment



The audio alarm has four sound levels.

1. Press and hold the time button and temperature buttons simultaneously. The display will show the current sound level. The toasters are factory set at level 4, and the display will read, **A L 4** for Alarm Level 4. See figure 3.

figure 3

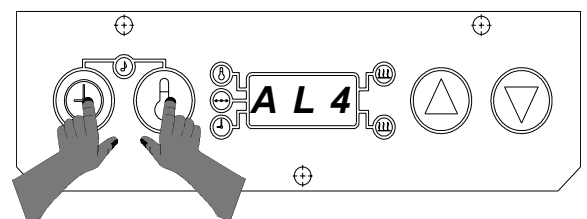

- While holding the time and temperature buttons, press the up or down arrow buttons to adjust the sound level. A continuous tone will sound. Release all buttons when the desired sound level is reached. The display will show the current sound level. See figure 4.

figure 4

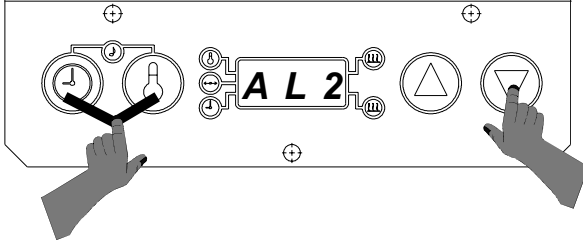

VIEW SET POINT TEMPERATURE

- Press and release the temperature button. (Do not hold for more than 6 seconds.) A beep will sound, the temperature indicator will turn on, and the display will show the set point temperature for three seconds. The display will then change to show the actual temperature. See figure 5.

figure 5

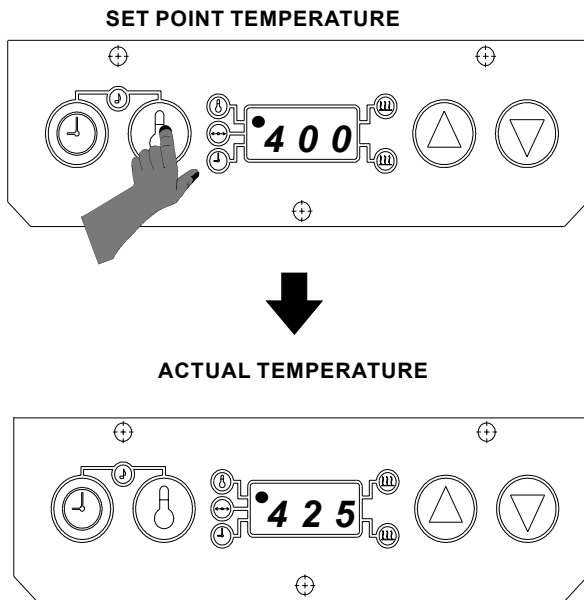

VIEW TIMER SETTING

- Press and release the time button. (Do not press the time button for more than 6 seconds.) The set time will be displayed for three seconds. If the timer is activated and is in a countdown sequence, the time remaining will be displayed, and will continue to countdown to zero. After three seconds, the display will change to show actual platen temperature. See figure 6.

figure 6

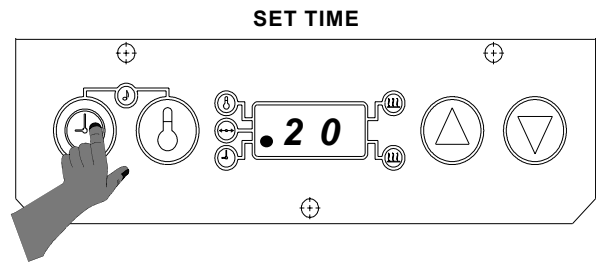

PROGRAMMING

The programming modes are used for setting individual set point temperature, and setting toast times.

Programming the Set Point Temperature

- Press and hold the temperature button for six seconds. A beep will sound, the temperature indicator light will blink, and the display will show the current set point temperature. See figure 7.

figure 7

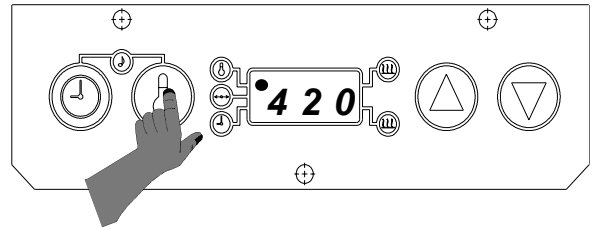

- To change the set point temperature, use the up or down arrow. Once the desired temperature is displayed, press the temperature button to store the new setting. See figure 8.

figure 8

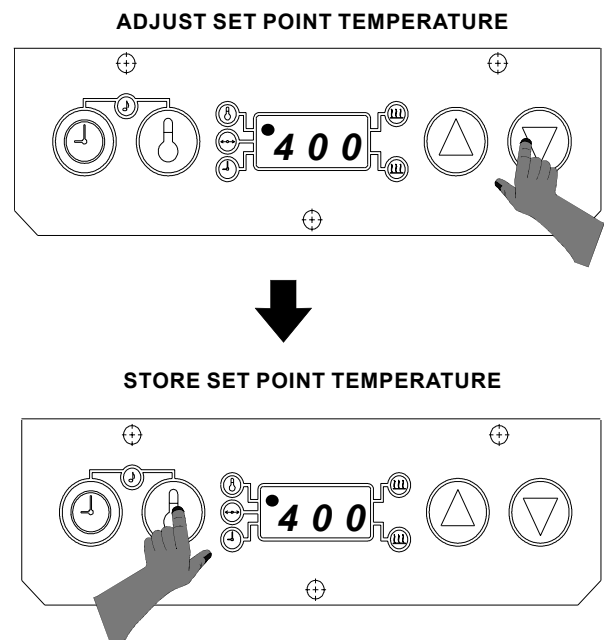

- To cancel the set point programming mode at any time, press and release the time button. The display will change to show the actual platen temperature. See figure 9.

figure 9

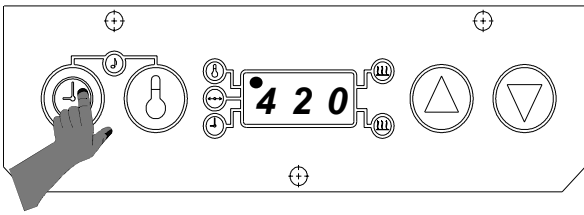

Programming Toast Times

- Press and hold the time button for 6 seconds. A beep will sound, and the time indicator light will blink. Release the time button to show the current toast time. See figure 10.

figure 10

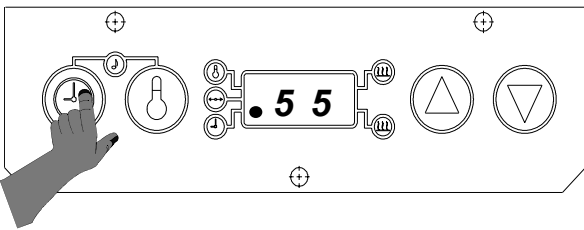

- Use the up and down arrow buttons to set your desired toast time. The range is from 20 seconds to 1 minute, 30 seconds. When desired time is reached, press and release the time button to store the new time. See figure 11.

figure 11

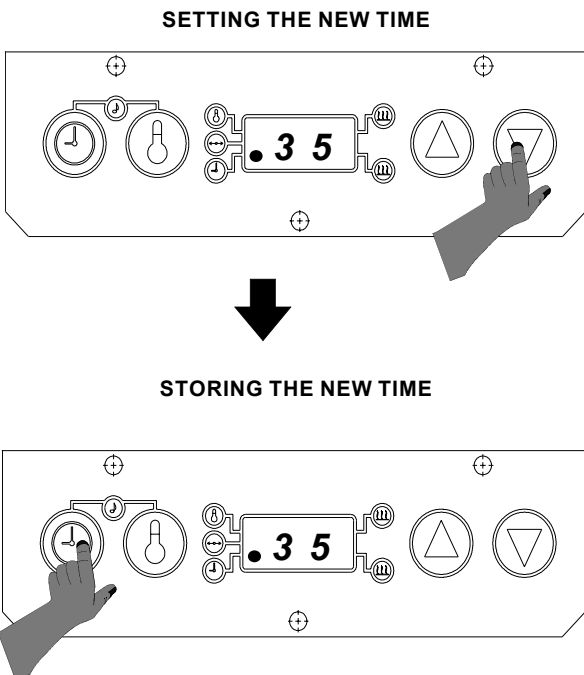

- To cancel the time set function at any time, press and release the temperature button. The time indicator light will turn off, and the display will change to show the actual platen temperature. See figure 12.

figure 12

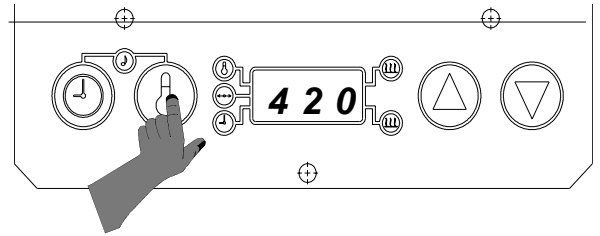

Stop Block Settings

(Refer to figures 13 and 14)

The Stop Blocks allow you to toast different sizes, cuts and brands of bread product. There are (6) combination stop block settings in 1/16" increments. The overall range is 7/6" to 1-1/8". The stop block settings allow you to get a better crush when toasting different styles of buns.

- Ensure stop blocks are on the correct setting before operating the toaster. There are (6) stop block combinations available.
- To change stop block setting, depress the right stop block to disengage locking pin and turn in either direction to the desired setting.
- View the stop block setting selected through the index window bracket which is located over each stop block. See figure 13.

figure 13

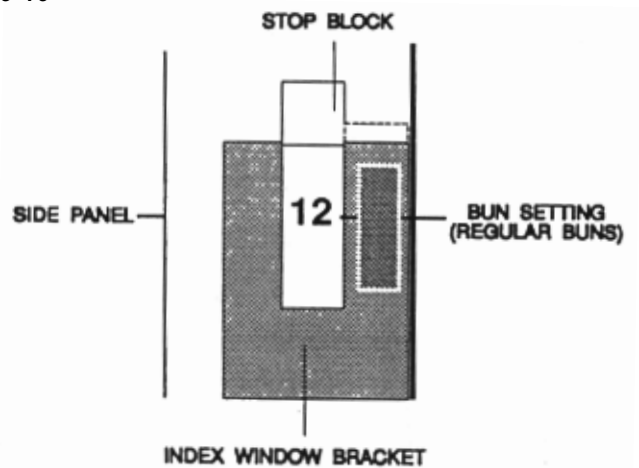

- Locate the selector lever (A) on the front of the toaster frame and move the lever left or right to allow you to switch back and forth between the combination setting selected on the stop block.

figure 14

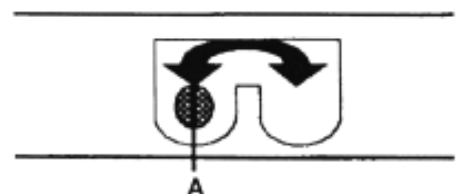

TOASTING BUNS

After selecting a cooking time and temperature, and setting the stop blocks and the center adjustment plate you are ready to begin toasting buns.

1. Using the bun tray place the crowns face up.
2. Using the bun spatula place the heels cut face down.
3. Lift the bun board on the upper platen up and insert the spatula with the heels on it.
4. Lower the bun board down on top of the heels and spatula. Slide the spatula out leaving heels on platen with bun board on top.
5. Insert the bun tray with the crowns into the lower section of the toaster or slide buns into the center section.

⚠ CAUTION: Be careful, platen is very hot.

6. Pull toaster handle forward to move platens on top of crowns, the timer will auto automatically activate and the red timer light will come on.

7. When the audio alarm sounds and the bun done light comes on, immediately push handle back to release crowns from platen. Remove crowns from toaster with spatula.
8. Lift bun board on upper platen and slide the spatula in under the heels and remove.

CLEANING

1. Press the power switch to the off position.
2. Unplug toaster.
3. Allow toaster and platens to cool down.
4. Wipe entire platen with clean, damp grill cloth. Full toaster cleaning must be done in the morning when toaster is cold. See your *Planned Maintenance Card* for proper cleaning procedures.





IMPORTANT: Do not drape cord over hot toaster bun board or platen. This will cause cord to burn.

TROUBLESHOOTING GUIDE

PROBLEM	CAUSE	SOLUTION
Platen loose.	Platen bolts loose.	Tighten platen bolts.
Speaker sounds, but no bun done light comes on.	Done light burned out.	Replace done light.
No audio alarm or amber colored bun "done" light.	Interconnect cable connection loose. Keyhole slot filled with debris. Speaker defective Opto-Sensor board defective	Check connections at Opto-Sensor board and main board. Clean keyhole slot. Replace speaker. Replace Opto-Sensor board.
Buns being crushed.	Stop blocks not adjusted properly. Warped bun trays. Buns cut improperly.	Adjust stop blocks. Straighten or replace bun trays. Contact bakery.
Platen does not heat.	No power. Power switch defective. Shorted power board. Platen burned out or shorted.	Check power source. Replace power switch. Replace power board. Check platen with ohmmeter for 11 ohms, if reading is less than 7 ohms or more than 14 ohms, replace platen.
No Display.	Fuse Defective.	Check fuse with ohmmeter, reading should be 1-2 ohms.

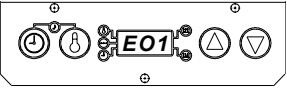
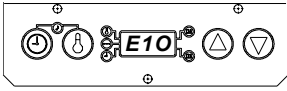
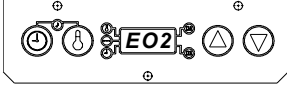
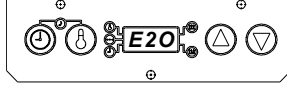
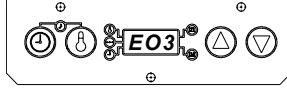
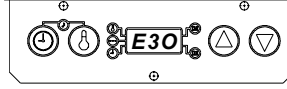
DIAGNOSTIC TROUBLESHOOTING

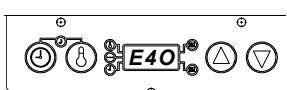
If the toaster malfunctions, the display will flash an error code **E** and a number between **1-9**, or a letter between **A-E**. Below are different error codes and their solutions. For Example If error code is **E01**, a failure related to the lower platen controls has occurred. If error code is **E10** a failure related to the upper platen controls has occurred.

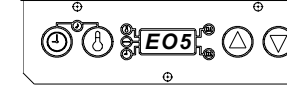
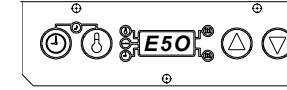
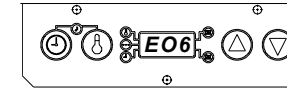
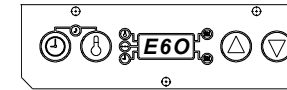
Diagnostics	Problem	Solution
 	<p>1. Lower Relay Contacts Shorted. Lower Platen Overheating.</p> <p>1. Upper Relay Contacts Shorted. Upper Platen Overheating.</p>	<p>Replace Lower Relay. Replace P. C. Board.</p> <p>Replace Upper Relay. Replace P. C. Board.</p>
 	<p>2. Lower Probe Open.</p> <p>2. Upper Probe Open</p>	<p>Replace Lower Probe.</p> <p>Replace Upper Probe.</p>
 	<p>3. Lower Failures 1 And 2 Combined</p> <p>3. Upper Failures 1 And 2 Combined</p>	
 	<p>4. Lower Platen Underheating.</p> <p>4. Upper Platen Underheating.</p>	<p>Replace Lower Relay. Check Lower Platen Resistance. Replace P. C. Board.</p> <p>Replace Upper Relay Check Upper Platen Resistance. Replace P. C. Board.</p>
	<p>Both Platens Underheating.</p> <p>2. A maximum of 900 sets of buns can be toasted in 1 hour, anything over that and the toaster can go into an E44 failure. If this happens discontinue using the toaster for 3 minutes and the failure will clear. You can then resume using the toaster again. If None of the above occurs, replace the P. C. Board.</p>	<p>1. Check For Cool Air Blowing On Toaster.</p>
 	<p>5. Lower Failures 1 And 4 Combined.</p> <p>5. Upper Failures 1 And 4 Combined.</p>	
 	<p>6. Lower Failures 2 And 4 Combined.</p> <p>6. Upper Failures 2 And 4 Combined.</p>	

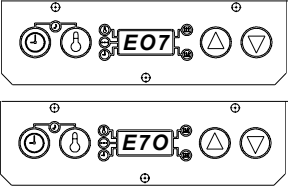
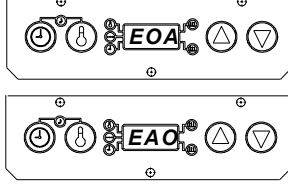
	<p>7. Lower Failures 1, 2 And 4 Combined.</p> <p>7. Upper Failures 1, 2 And 4 Combined.</p>	
	<p>8. Lower Probe Circuit Failure.</p> <p>8. Upper Probe Circuit Failure.</p>	<p>Replace P. C. Board.</p> <p>Replace P. C. Board.</p>
	<p>9. Lower Failures 1 And 8 Combined.</p> <p>9. Upper Failures 1 And 8 Combined.</p>	
	<p>10. Lower Failures 2 And 8 Combined.</p> <p>10. Upper Failures 2 And 8 Combined.</p>	
	<p>11. Lower Failures 1, 2 And 8 Combined.</p> <p>11. Upper Failures 1, 2 And 8 Combined.</p>	
	<p>12. Lower Failures 4 And 8 Combined.</p> <p>12. Upper Failures 4 And 8 Combined.</p>	
	<p>13. Lower Failures 1, 4 And 8 Combined.</p> <p>13. Upper Failures 1, 4 And 8 Combined.</p>	
	<p>14. Lower Failures 2, 4 And 8 Combined.</p> <p>14. Upper Failures 2, 4 And 8 Combined.</p>	

