

OPERATING INSTRUCTIONS

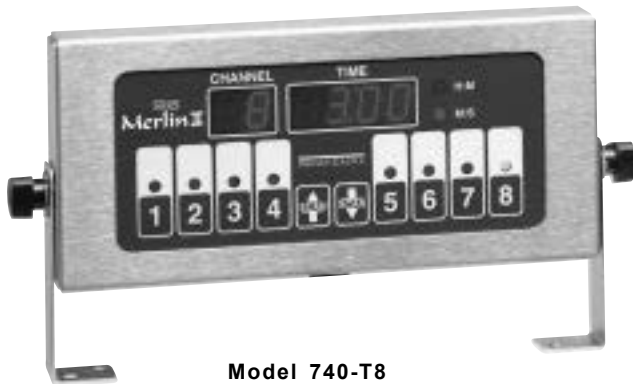

Merlin II

Single Function Timers Model No. 740-T, 740-TJ & 740-TF Series



Model 740-T8

Prince Castle's second generation of Merlin Timers feature a new slim design which gives you mounting flexibility. The 740 Series Timers are designed so each channel can be programmed independently, and used simultaneously. The timers are simple to program and simple to use. The push of a button activates each channel, and a alarm and multi-colored flashing channel buttons alert the operator when timing is complete.

ELECTRICAL

740-T Series

120 Volts
50-60 Hz

740-TJ Series

100 Volts
50/60 Hz

740-TF Series

220-240 Volts
50/60 Hz

TABLE OF CONTENTS

PAGE

Installation	2
Programming	2
Operation	3
Cleaning	4
Parts List	4
Exploded View	5
Troubleshooting	5
Wiring Diagrams	6

LIMITED WARRANTY

This product is warranted to be free from defects in material and/or workmanship for a period of 1 year from date of original installation, not to exceed 18 months from the date of manufacture.

Any component which proves to be faulty in material and/or workmanship will be replaced or repaired (at the option of Prince Castle, Inc.) without cost to the customer for parts and labor. This equipment is portable; charges for on-location service (e.g., trip charges, mileage) are not included in the provisions of this warranty.

This warranty is subject to the following exceptions/conditions:

- Use of any non-genuine Prince Castle parts voids this warranty.
- All labor to be performed during regular work hours. Overtime premium (the incremental amount) will be charged to the customer.
- Damage caused by carelessness, neglect and/or abuse (e.g., dropping, tampering or altering parts, equipment damaged in shipment, by fire, flood or an act of God) is not covered under this warranty.
- All problems due to operation at voltages other than that specified on equipment nameplates are not covered by this warranty. Conversion to correct voltage is the customer's responsibility.
- This equipment must be serviced by Prince Castle Authorized Service Agency or a Prince Castle Service Technician during the warranty period.

INSTALLATION

- After you have removed the timer from the carton, inspect the unit for signs of damage. If there is damage to the unit:
 - Notify carrier within 24 hours after delivery.
 - Save carton and packing materials for inspection purposes.
 - Contact your local Prince Castle dealer or, if purchased directly, the Prince Castle Customer Sales Department at 1-630-462-8800 to arrange for a replacement to be sent.
- Verify that all parts have been received. Mounting brackets and hardware are provided.
- To mount the timer, place mounting brackets in desired location. Scribe location of mounting holes, center punch, and drill holes. Attach timer to mounting brackets placing star washer between bracket and timer.

DISPLAYS AND INDICATORS

TIME Display	Shows the time for the selected channel number.
CHANNEL Display	Shows the channel number selected and in use. (The 740-T2 model does not have this display.)
H:M	Indicates the time value is in H ours and M inutes.
M:S	Indicates that the time value is in M inutes and S econds.
LED Indicators	Located above each channel timer button, these lights change color depending on the stage of the countdown. Green = first 70% of countdown, Yellow = next 20% countdown, Red = last 10% of countdown.

CONTROLS

Channel (Timer)	The 740-T2 has 2 channels, the 740-T4 has 4 channels, the 740-T8 has 8 channels and the 740-T12 has 12 channels.
------------------------	--

SCAN/UP ARROW



In the program mode, it increases time values for each channel. In the Run Mode, it is used in conjunction with logo button to increase the volume.

SCAN/DOWN ARROW



In the program mode, it decreases time values for each channel. In the run mode, it is used in conjunction with logo button to decrease the volume.

PRINCE CASTLE Logo

Activates Program Mode and used to adjust the alarm sound level.

PROGRAMMING

- To program, press and hold the **PRINCE CASTLE** logo for six seconds. The **TIME** display changes from ---- to **Prog**, and a beep will sound. See figure 1.

figure 1

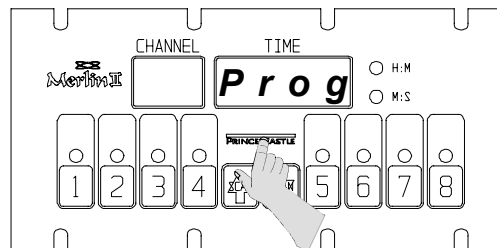

- Select and press the timer channel to be programmed. The LED indicator for the selected channel will turn yellow and a beep will sound. The selected channel number will be displayed in the **CHANNEL** display, the current programmed time for that channel will be displayed in the **TIME** display, and the time value will indicate either **H:M** OR **M:S**. See figure 2.

figure 2

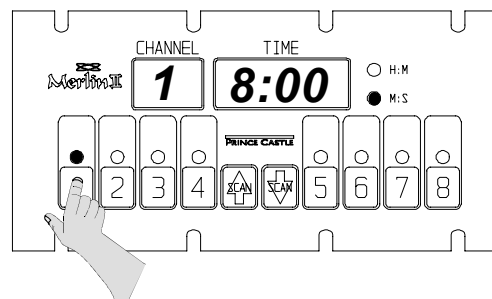

- To change the program time for the selected channel, use the **SCAN/UP Arrow** or the **SCAN/DOWN Arrow** button.

IMPORTANT: To change from Minutes and Seconds **M:S** to Hours and Minutes **H:M**, press and hold the SCAN/UP Button. When the display reaches 59:59 it will automatically change to 1:00 Hour and the LED will switch from M:S to H:M. The program value for the **H:M** indicator is from 1:00 hour to 17 hours: 59 minutes. See figures 3 and 4.

figure 3

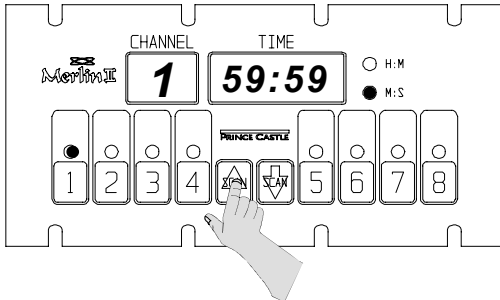
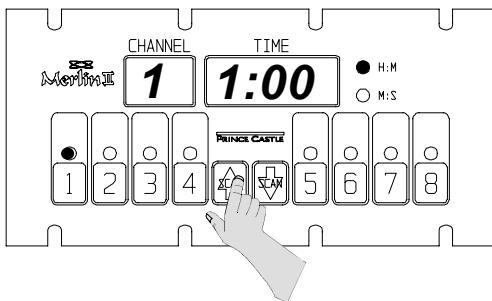
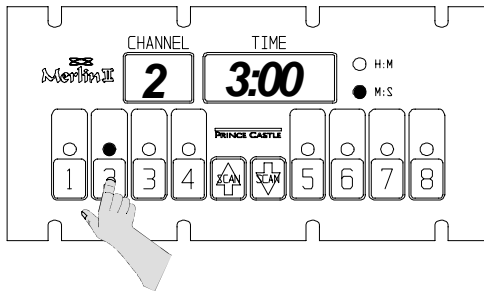

figure 4



4. To program another channel, press the desired channel button. Repeat programming procedures in steps 2 and 3 above. See figure 5.

figure 5



5. When finished programming each desired channel, momentarily press the **PRINCE CASTLE** logo to end the Program Mode. This saves the program changes you have made for all channels. See figure 6.

figure 6

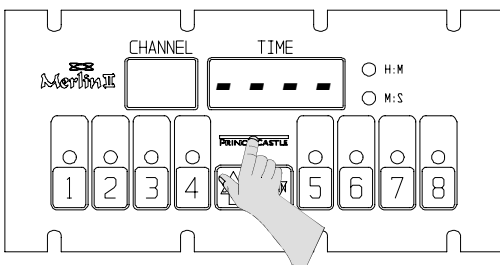

6. This timer is equipped with programmable volume(S-3, S-2, S-1 & OFF) levels. The timer volume can be adjusted by pressing and holding (for less than 6 seconds) the **Prince Castle Logo** and simultaneously either the **UP** or **DOWN ARROW** buttons. The display will show either S-3 (High Volume), S-2 (Medium Volume), S-1 (Low Volume) or OFF (No alarm, only key press feedback tones). To increase the volume press the **UP ARROW**, to decrease the volume press the **DOWN ARROW**. See figure 7.

figure 7

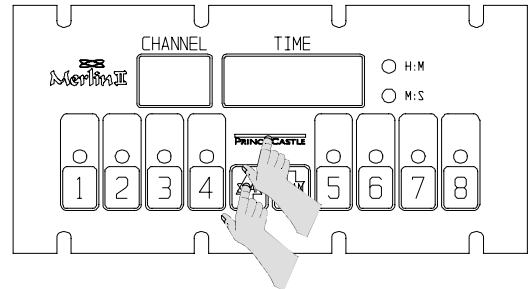

OPERATION

1. Press a channel button to activate a timing cycle. (All channels can be activated and running at the same time.) The time channel number with the least amount of time remaining will be displayed in the **CHANNEL** display, its time remaining will countdown in the **TIME** display, and the time value **M:S** or **H:M** will be illuminated. See figure 8.

figure 8

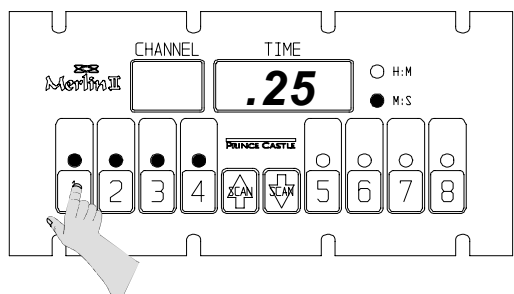

2. Press the desired channel button three times within five seconds to cancel an active timing cycle.

IMPORTANT: The channel timer button's multi-colored LED indicator shows the status of the timer. The indicator has three colors: green, yellow, and red. The LED will be green during the first 70% of the countdown. It changes to yellow during the next 20% of the countdown. It will be red during the final 10% of the countdown, and will start flashing red once the time has run out.

- The timer will countdown from the programmed value to zero. At zero, the display flashes **End** and the alarm sounds. See figure 9.

figure 9

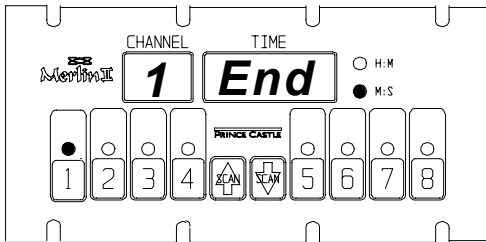

IMPORTANT: There are three indicators that signal the operator when the timing cycle is complete: The **CHANNEL** display shows the channel associated with the alarm. The **TIME** display shows **End**. The LED indicator in the channel button flashes red.

- When the timing cycle is complete, and the alarm sounds, press the channel button with the flashing red indicator to cancel the alarm. See figure 10.

figure 10

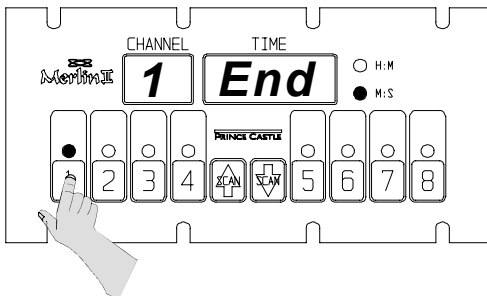

- The scan feature is used to check the time values on other active channels. There are two different ways to scan active channels. Press the **SCAN/UP** or **SCAN/DOWN** button. Or press any of the active timer **CHANNEL** buttons. If no other button is pressed within 5 seconds, the display will change to show the timer with the least amount of time left. See figure 11.

figure 11

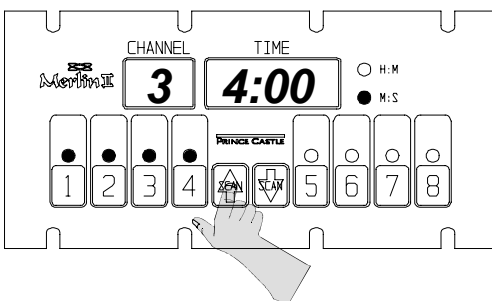

CLEANING

- Do not allow grease to build up on the timer, wipe it down daily with clean damp cloth.

IMPORTANT: Do not use abrasive or chemical cleaners on your timer, this may cause damage to the overlay.

PART LIST

ITEM	PART NUMBER	DESCRIPTION
1	69-079S	Rivet Plastic Push Pin
2	69-080	Self Retaining Nut
3	73-014	Hex Nut #4-40 S.S.
4	73-021	Hex Nut #8-32 S.S.
5	88-653-2-4S	Speaker Assy.
	88-653-2-11S	Speaker Assy. (740-T4)
6	735-240S	Switch Panel Assy. (740-T2)
	735-211S	Switch Panel Assy. (740-T4)
	735-205S	Switch Panel Assy. (740-T8)
	735-208S	Switch Panel Assy. (740-T12)
7	735-237	Front Bezel (740-T2)
	735-223	Front Bezel (740-T4)
	735-226	Front Bezel (740-T8)
	735-229	Front Bezel (740-T12)
8	735-238	Rear Cover (740-T2)
	735-224	Rear Cover (740-T4)
	735-227	Rear Cover (740-T8)
	735-230	Rear Cover (740-T12)
9	740-9S	Main P.C.Board (740-T2)
	740-218S	Main P.C.Board (740-T4,740-T8 & 740-T12)
10	740-13S	P.C.Board Wing (740-T8)
	740-15S	P.C.Board Wing (740-T12)
11	70-048S	Knobs (with washers)
12	79-079	Washer
13	72-292S	Power Supply (110 V)*
	72-293-01JS	Power Supply (200 V)
	72-293-04FS	Power Supply (220-240 V)
*	735-241	Wall Mounting Bracket
*	735-242	Table Mounting Bracket
	*72-335S	Power Supply (740-T12PM, 740-T12AMP, 110V)
	*740-282S	Switch Panel Assy. (740-T12PM)
	*740-407S	Switch Panel Assy. (740-T12AMP)

EXPLODED VIEW

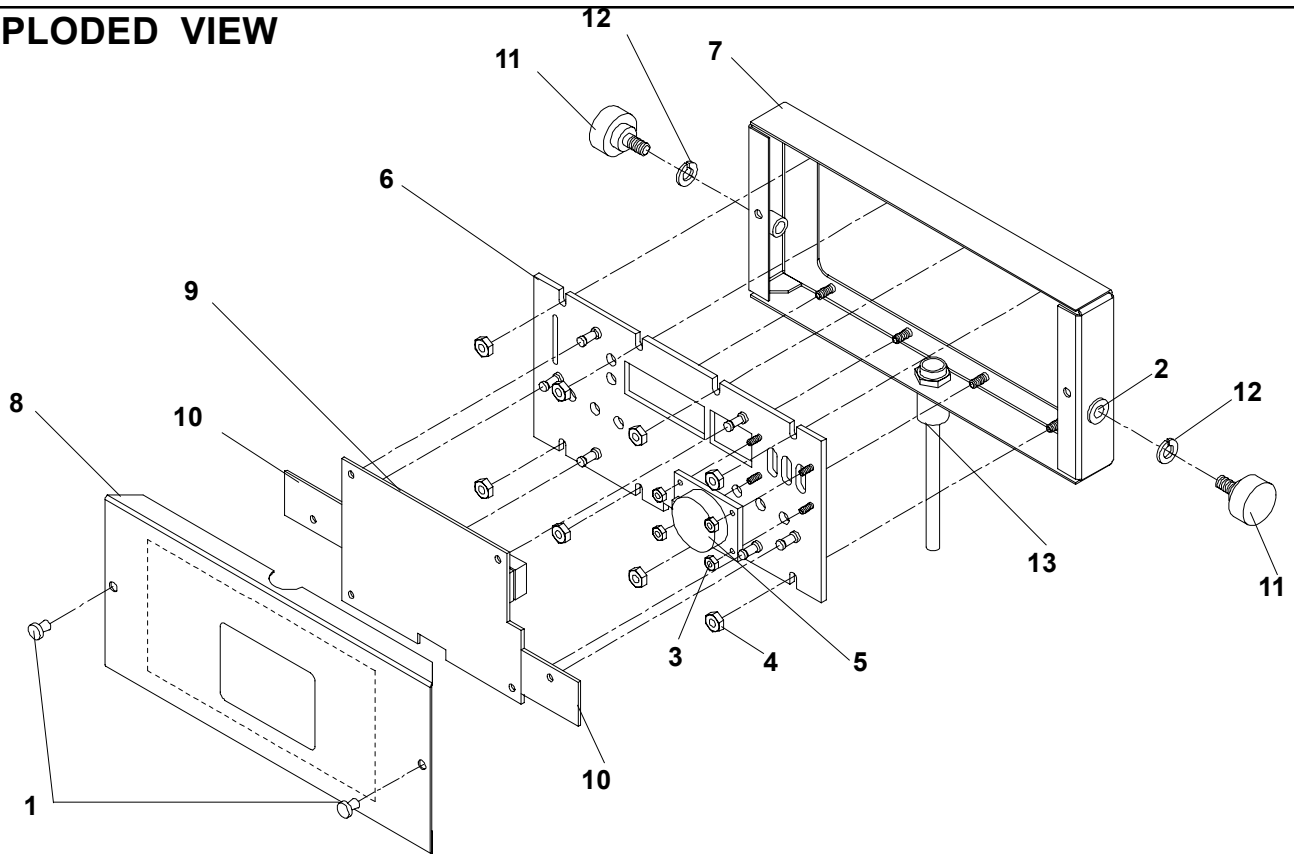

TROUBLESHOOTING GUIDE

PROBLEM	CAUSE	SOLUTION
A. No displays or indicators lit.	Unit unplugged. Store's circuit breaker blown. Defective transformer. Circuit inoperable.	Plug unit in. Reset breaker. Replace Main Circuit Board. Replace Main Circuit Board.
B. Absence of Audio Alarm.	Speaker inoperable. Circuit inoperable.	Replace Speaker. Replace Main Circuit Board.
C. Unit will not enter program mode. Display does not show "Prog" .	All channels are still counting. Logo Switch inoperable.	Wait until channels are in stop mode. Replace Switch Panel.
D. Unit enters program mode. Display shows "Prog" , but cannot change times.	The channel is still counting. Arrow Switch inoperable. Circuit inoperable.	Wait until channel is in stop mode. Replace Switch Panel. Replace Main Circuit Board.
E. Unable to start, stop, or store timer presets in program mode. Missing or abnormal characters in displays.	Circuit inoperable.	Replace Switch Panel. If problem persists, replace Main Circuit Board.
F. "8888" flashing in display with a constant audio alarm.	Unit is in test mode	Unplug timer, hold in both the Up and Down arrows while plugging in. This will exit timer from test mode.

WIRING DIAGRAM 740-T4,T8 &T12

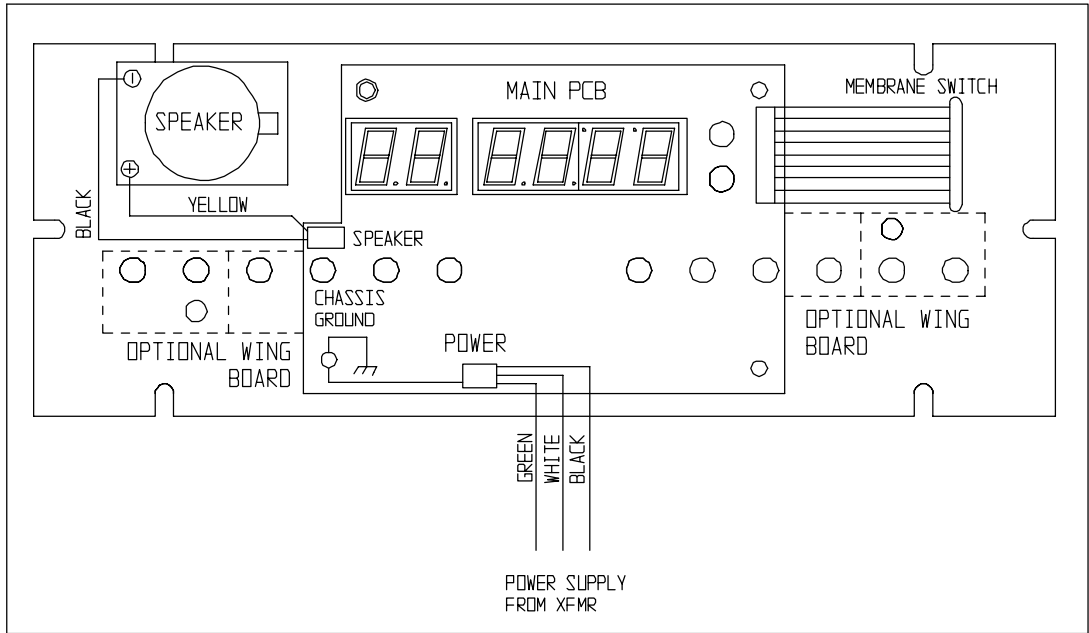

WIRING DIAGRAM 740-T2

