

# OPERATING INSTRUCTIONS

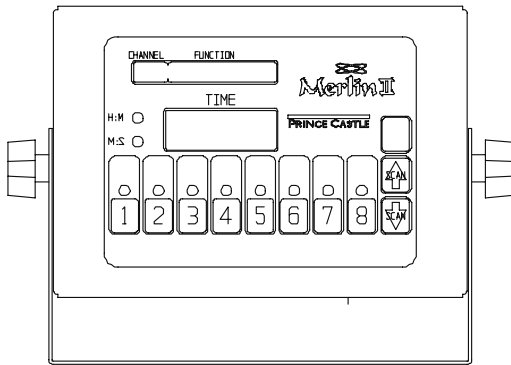

## Merlin II

### Multi-Function Timers 840-T, 840-TJ & 840-TF Series



**Pictured Model 840-T8**

Prince Castle's second generation of Merlin Timers feature a new slim design which gives you mounting flexibility. The 840 Series Timers are designed so each channel can be programmed independently, and used simultaneously. The push of a button activates each channel, and a alarm and multi-colored flashing channel buttons alert the operator when timing is complete.

## ELECTRICAL

### 840-T Series

120 Volts  
50-60 Hz

### 840-TJ Series

100 Volts  
50/60 Hz

### 840-TF Series

220-240 Volts  
50/60 Hz

## TABLE OF CONTENTS

PAGE

Installation .....	2
Programming .....	2-3
Operation .....	4
Cleaning .....	4
Parts List.....	5
Exploded View .....	5
Troubleshooting .....	6
Wiring Diagrams .....	6

### LIMITED WARRANTY

This product is warranted to be free from defects in material and/or workmanship for a period of 1 year from date of original installation, not to exceed 18 months from the date of manufacture.

Any component which proves to be faulty in material and/or workmanship will be replaced or repaired (at the option of Prince Castle, Inc.) without cost to the customer for parts and labor. This equipment is portable; charges for on-location service (e.g., trip charges, mileage) are not included in the provisions of this warranty.

This warranty is subject to the following exceptions/conditions:

- Use of any non-genuine Prince Castle parts voids this warranty.
- All labor to be performed during regular work hours. Overtime premium (the incremental amount) will be charged to the customer.
- Damage caused by carelessness, neglect and/or abuse (e.g., dropping, tampering or altering parts, equipment damaged in shipment, by fire, flood or an act of God) is not covered under this warranty.
- All problems due to operation at voltages other than that specified on equipment nameplates are not covered by this warranty. Conversion to correct voltage is the customer's responsibility.
- This equipment must be serviced by Prince Castle Authorized Service Agency or a Prince Castle Service Technician during the warranty period.

# INSTALLATION

- After you have removed the timer from the carton, inspect the unit for signs of damage. If there is damage to the unit:
  - Notify carrier within 24 hours after delivery.
  - Save carton and packing materials for inspection purposes.
  - Contact your local dealer or, if purchased directly, the Prince Castle Customer Sales Department at 1-800-722-7853 to arrange for a replacement to be sent.
- Verify that all parts have been received. Mounting bracket and hardware are provided.
- To mount the timer, place mounting brackets in desired location. Scribe location of mounting holes, center punch, and drill holes. Attach timer to mounting brackets placing star washer between bracket and timer.

- Select and press the timer channel to be programmed. The LED indicator for the selected button will turn yellow and a beep will sound. The **CHANNEL/FUNCTION** display will read, **CKT=COOK TIME** ↑↓ with up and down arrows. The current complete cook time (**Factory Preset 3:00 M:S**) for that channel will be displayed in the **TIME** display, and the time value will indicate either **H:M** or **M:S**.

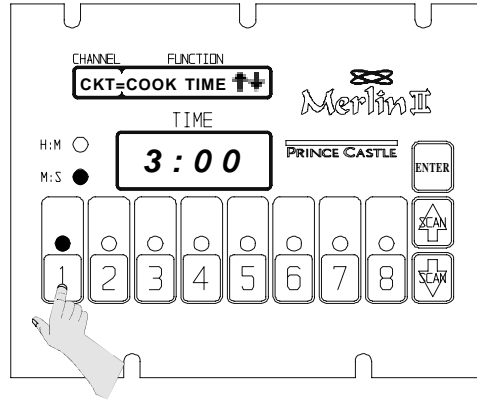

- At this point, program in your complete cook time by using the **SCAN/UP Arrow** or the **SCAN/DOWN Arrow** button. Once you have reached your desired time press the **ENTER** button to store your complete cook time. **Note:** The Enter button must be pressed after any time changes in the cook, duty or hold functions or the the time change will not be stored.

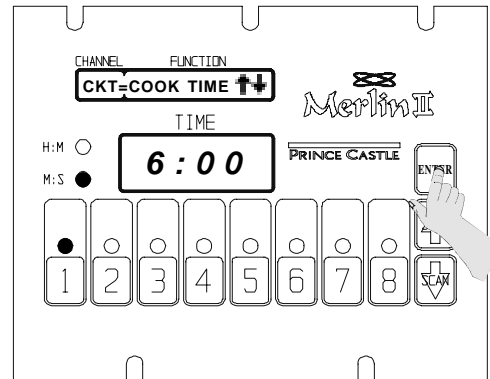

# PROGRAMMING

**Note:** The 6 following functions can be programmed on each channel:

- Total Cook Time: ( Factory Preset 3:00 Minutes)
- 1st Duty During Cook Time: (Factory Preset :30 Sec.)
- 2nd Duty During Cook Time:(Factory Preset 1:00 Min.)
- 3rd Duty During Cook Time:(Factory Preset 1:30 Min)
- Hold Time: (Factory Preset 2:00 Minutes)
- Duty During Hold Time: No Preset Time.

Each function programs in the same manner, first setting the time, then setting the alarm cancel mode (Automatic or Manual) and finally naming the function.

- To program, press and hold the **PRINCE CASTLE LOGO** for eight seconds, a beep will sound and the **CHANNEL/FUNCTION DISPLAY** will read **SEL CH/ LOGO = QUIT**.

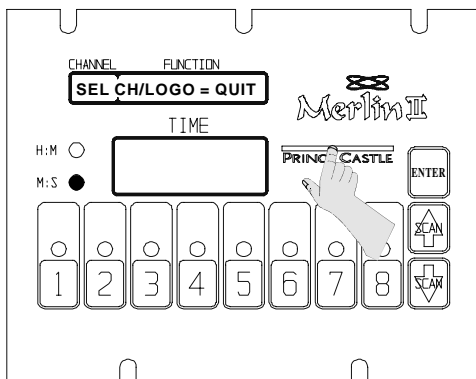

**IMPORTANT:** To change from Minutes and Seconds **M:S** to Hours and Minutes **H:M**. Press and hold the **SCAN/UP** Button. When the display reaches 59:59 it will automatically change to 1:00 Hour and the LED will switch from **M:S** to **H:M**. The program value for the **H:M** indicator is from 1:00 hour to 17 hours: 59 minutes.

- Once you press **ENTER**, The **CHANNEL/FUNCTION** display switches to **CKC=MAN CANCEL**  $\uparrow\downarrow$ , this allows you to select a manual or an automatic alarm cancel, press the **SCAN UP** arrow or **SCAN DOWN** arrow to toggle between **AUT** and **MAN** Cancel. Press the **ENTER** button to store your selection.

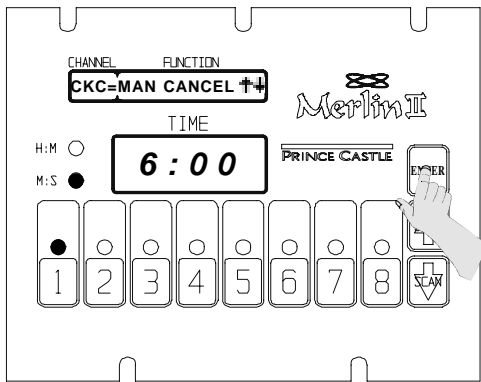

- After you press **ENTER**, the **CHANNEL/FUNCTION** display will change to **CKL=COOK**. To select an alternate function (see list below) use the **SCAN UP** or **SCAN DOWN** arrows. Press **ENTER** to store the selection. The function name selected will be displayed during the final countdown sequence.

**Note:** The function name options are as follows:

BAKE, BAKE MORE, BASTE, BRAISE, CHILL, COOK, COOK DUTY 1, COOK DUTY 2, COOK DUTY 3, COOK MORE, COVER, DISCARD, DONE, DROP, END, FOLD, FRY, FRY MORE, GRILL, GRILL MORE, HOLD, HOLD DUTY, MIX, POACH, POUR, REMOVE, ROTATE, SEAR, SHAKE, SIDE 1, SIDE 2, STIR, TURN, WHIP And WRAP.

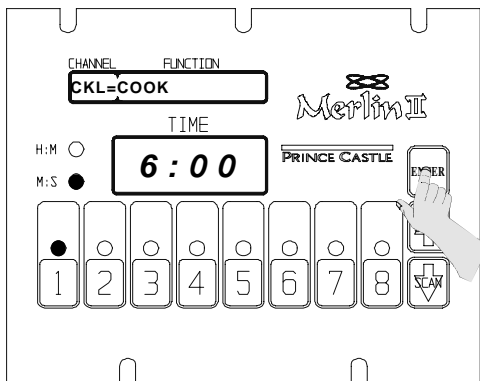

- After pressing the **ENTER** button, the **CHANNEL/FUNCTION** display will read **CKT=COOK TIME**. To move on to the **DUTY** function press the selected **CHANNEL BUTTON** once. The **CHANNEL/FUNCTION** display reads **D1T=DUTY 1 TIME**  $\uparrow\downarrow$  and **:30 Seconds** (The Factory Preset) will appear in the **TIME DISPLAY**.

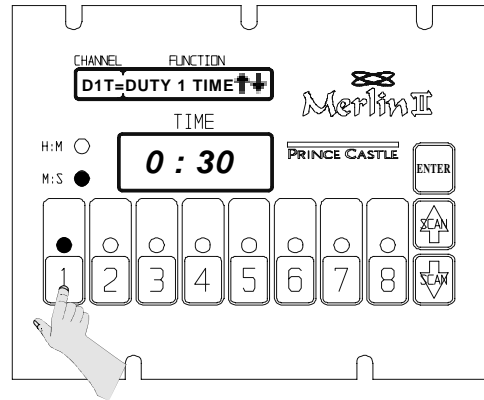

- To set the **DUTY TIME** Press the **SCAN UP** Arrow Button. If no **DUTY TIME** is desired use the **SCAN DOWN** Arrow Button to set the **DUTY TIME** to **0:00**, press **ENTER** to store your setting.

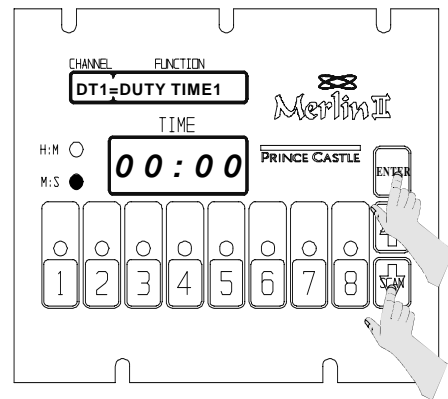

- Once you press **ENTER**, The **CHANNEL/FUNCTION** display switches to **D1C=MAN CANCEL**  $\uparrow\downarrow$ , this allows you to select a manual or an automatic alarm cancel, press the **SCAN UP** arrow or **SCAN DOWN** arrow to toggle between **AUT** and **MAN** Cancel. Press the **ENTER** button to store your selection.

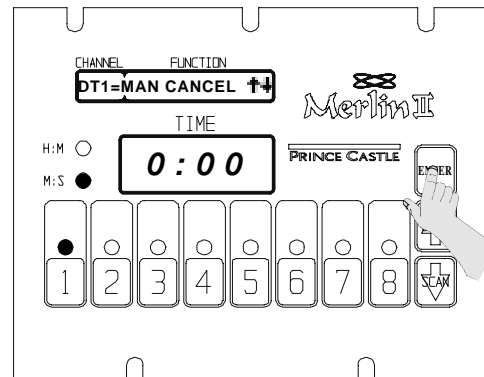

- After you press **ENTER**, the **CHANNEL/FUNCTION** display will change to **CKL=COOK**. To select an alternate function (see list by step 5) use the **SCAN UP** or **SCAN DOWN** arrows. Press **ENTER** to store the selection. The function name selected will be displayed during the **DUTY 1** sequence.

10. After pressing the **ENTER** button, the **CHANNEL/FUNCTION** display will read **D1T=DUTY 1 TIME ↑↓**. To move on to the **DUTY 2** function press the selected **CHANNEL BUTTON** once. The **CHANNEL/FUNCTION** display reads **D2T=DUTY 2 TIME ↑↓** and **:00 Seconds** (The Factory Preset) will appear in the **TIME DISPLAY**.
11. Repeat steps 6-10 for **DUTY 2, DUTY 3, HOLD** and **HOLD DUTY** Settings. **NOTE:** The **HOLD FUNCTION** is preset at the factory for **2:00 M:S**, if no **HOLD TIME** is desired you must set the **HOLD FUNCTION** to **00:00**.
12. After you have completed programming the **HOLD DUTY FUNCTION**, press the **CHANNEL BUTTON** again, the display will read **SEL CH/LOGO=QUIT**. Select another channel button to program, or press the **PRINCE CASTLE LOGO** to return to the **RUN MODE**.
13. You can change the sound level of the alarm in **RUN MODE**. Press and hold the **PRINCE CASTLE LOGO** ; then, within six seconds, press either the **SCAN UP** Arrow button or the **SCAN DOWN** Arrow button. The **SCAN UP** Arrow button adjusts the sound level to the louder alarm, and the **SCAN DOWN** Arrow button adjusts the sound level to the lower alarm.

**IMPORTANT:** The channel timer button's multi-colored LED indicator shows the status of the timer. The indicator has three colors: green, yellow, and red. The LED will be green during the first 70% of the countdown. It changes to yellow during the next 20% of the countdown. It will be red during the final 10% of the countdown, and will start flashing red once the time has run out.

**Note:** If a Manual Cancel is programmed into a duty function the LED will flash red until the channel button has been pressed. If an Automatic Cancel is programmed the LED will flash green for 5 seconds and the alarm will automatically turn off.

3. The timer will countdown from the programmed value to zero. When the complete cooked time is finished, the display flashes **0 0** and the alarm sounds.
4. When the timing cycle is complete, and the alarm sounds, press the channel button with the flashing red indicator to cancel the alarm.
5. The scan feature is used to check the time values on other active channels. There are two different ways to scan active channels. Press the **SCAN/UP** or **SCAN/DOWN** button. Or press any of the active timer **CHANNEL** buttons. If no other button is pressed within 5 seconds, the display will change to show the timer with the least amount of time left.

## OPERATION

1. Press a channel button to activate a timing cycle. (All channels can be activated and running at the same time.) The channel with the least amount of function time remaining will be displayed in the **CHANNEL/FUNCTION** display along with the next function. The time remaining will countdown in the **TIME** display, and the time value **M:S** or **H:M** will be illuminated.

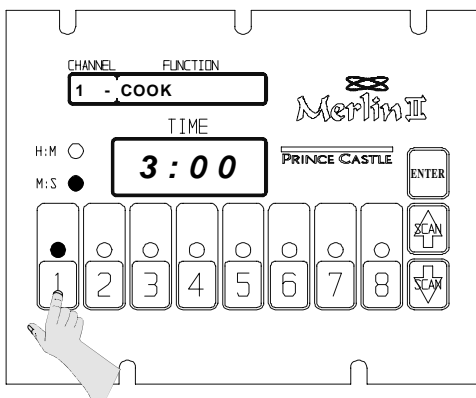

2. Press the desired channel button three times within five seconds to cancel an active timing cycle.

## CLEANING

1. Do not allow grease to build up on the timer, wipe it down daily with clean damp cloth.

**IMPORTANT:** Do not use abrasive or chemical cleaners on your timer, this may cause damage to the overlay.

# EXPLODED VIEW

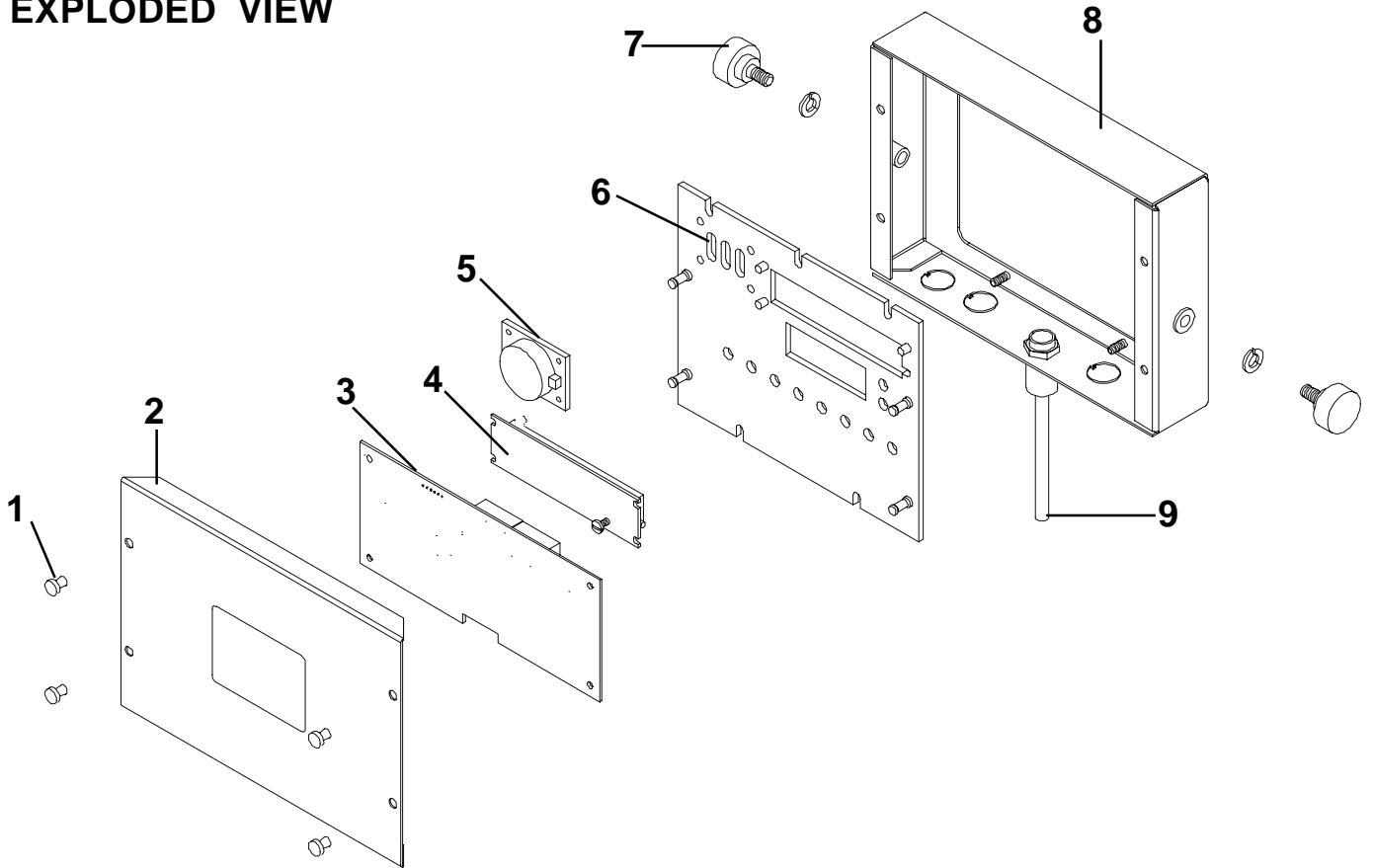

## PART LIST

<u>ITEM</u>	<u>PARTNUMBER</u>	<u>DESCRIPTION</u>
1	69-079	Rivet Plastic Push Pin
2	840-100	Rear Cover
3	840-108S	Main P.C.Board
	840-109S	Auxillary P.C.Board (840-T8D & 840-T16D)
4	71-142-02S	Display Board
5	88-653-2-4S	Speaker Assy.
6	840-096S	Switch Panel Assy. (840-T8 Series)
	840-110S	Switch Panel Assy. (840-T4 Series)
7	70-048S	Knob W/Washer (Pkg of 2)
8	840-103	Chassis (840-T4 & T8)
	840-115	Chassis (840-T8D & T16D)
9	72-292S	Power Supply (110-120V)
	72-293-01JS	Power Supply (100V)
	72-293-04FS	Power Supply (220-240V)

# WIRING DIAGRAM 840-T Series

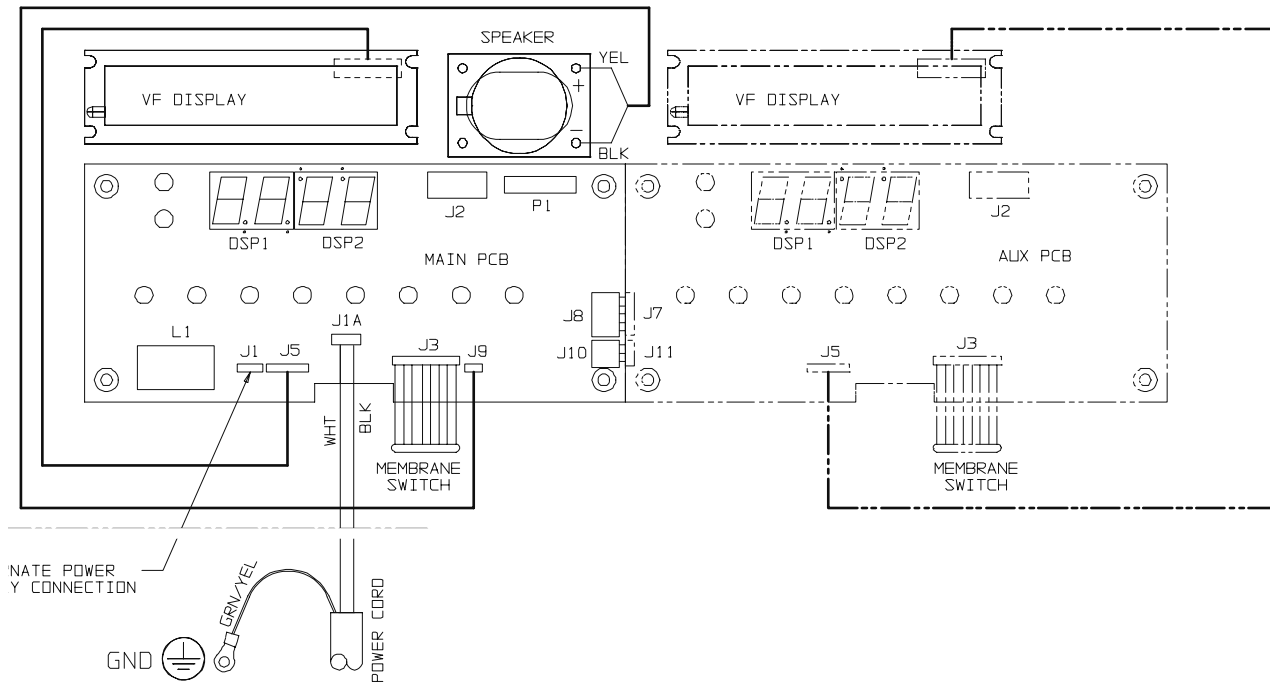

## TROUBLESHOOTING GUIDE

PROBLEM	CAUSE	SOLUTION
A. No displays or indicators lit.	Unit unplugged. Store's circuit breaker blown. Defective transformer. Circuit inoperable.	Plug unit in. Reset breaker. Replace Main Circuit Board. Replace Main Circuit Board.
B. Absence of Audio Alarm.	Speaker inoperable. Circuit inoperable.	Replace Speaker. Replace Main Circuit Board.
C. Unit will not enter program mode.	All channels are still counting. Logo Switch inoperable.	Wait until channels are in stop mode. Replace Switch Panel.
D. Unit enters program mode. but cannot change times.	The channel is still counting. Arrow Switch inoperable. Circuit Inoperable	Wait until channel is in stop mode. Replace Switch Panel. Replace Main Circuit Board.
E. Unable to start, stop, or store timer presets in program mode. Missing or abnormal characters in displays.	Circuit inoperable.	Replace Switch Panel. If problem persists, replace Main Circuit Board.