

Operation Manual

Product Holding Bin
DHB2PT Series

Product Identification

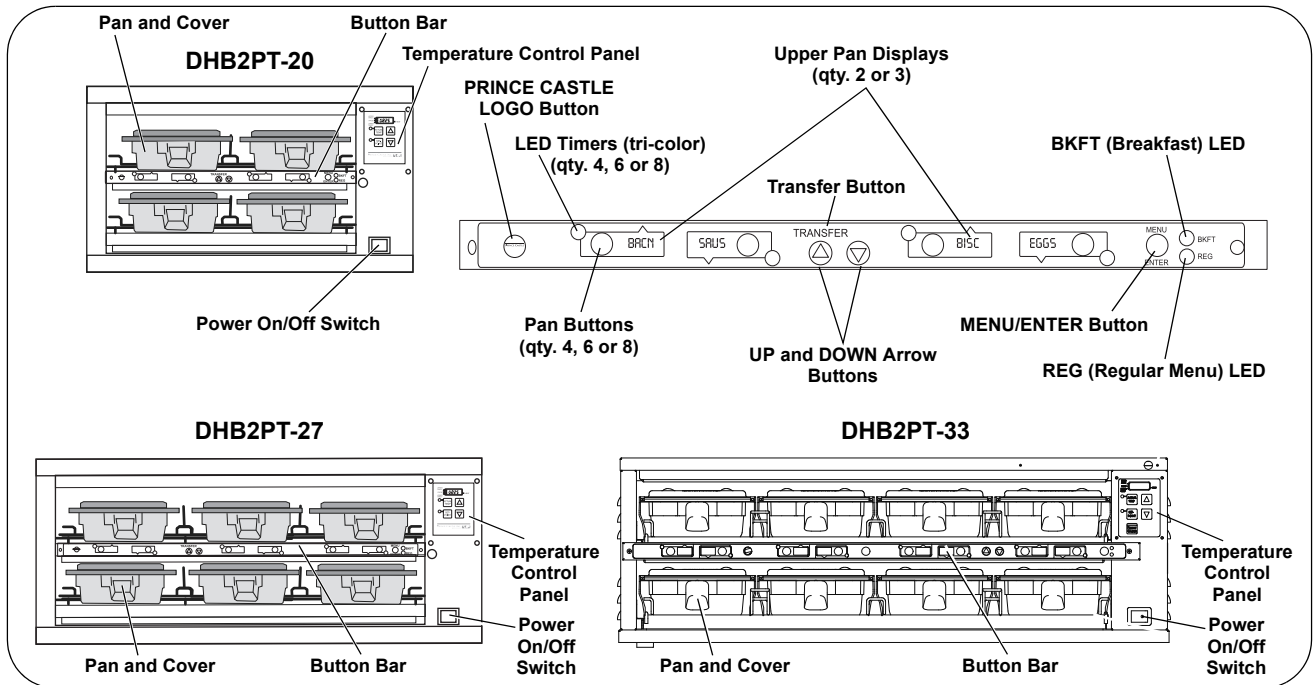

LIMITED WARRANTY

This product is warranted to be free from defects in material and/or workmanship for a period of 1 year from date of original installation, not to exceed 18 months from the date of manufacture.

Any component which proves to be faulty in material and/or workmanship will be replaced or repaired (at the option of Prince Castle, Inc.) without cost to the customer for parts and labor. This warranty covers on-location service (i.e. trip charges and/or mileage). Travel mileage is limited to 100 miles (200 Kilometers) round trip (one trip warranty) from an authorized service agency or its sub-service agency.

This warranty is subject to the following exceptions/conditions:

- Use of any non-genuine Prince Castle parts voids this warranty.
- All labor to be performed during regular work hours. Overtime premium (the incremental amount) will be charged to the customer.
- Damage caused by carelessness, neglect and/or abuse (e.g., dropping, tampering or altering parts, equipment damaged in shipment, by fire, flood or an act of God) is not covered under this warranty.
- All problems due to operation at voltages other than that specified on equipment nameplates are not covered by this warranty. Conversion to correct voltage is the customer's responsibility.
- This equipment must be serviced by Prince Castle Authorized Service Agency or a Prince Castle Service Technician during the warranty period.

TABLE OF CONTENTS

Product Identification	1
Safety Information	2
Installation	2
Operation	3
Cleaning	4
Programming	7 – 10
CastleNet® Communications Network	11
Factory Presets	12
Troubleshooting	13
Exploded View and Parts List (DHB2PT-20B)	14
Exploded View and Parts List (DHB2PT-27B/-27BCE)	15
Exploded View and Parts List (DHB2PT-33)	16
Wiring Diagram	17



PRINCE CASTLE LLC
WORLDWIDE

355 East Kehoe Blvd. • Carol Stream, IL 60188 USA
Telephone: 630-462-8800 • Toll Free: 1-800-PCASTLE
Fax: 630-462-1460 • www.princecastle.com

Specifications

Model	Volts	Watts	Hertz	Model	Volts	Watts	Hertz
DHB2PT-20B	120	1700	60	DHB2PT-20BCE	220 – 240	1500	50
DHB2PT-27B	120	1650	60	DHB2PT-33BCE	240	2600	50
DHB2PT-27BCE	230	2500	50	DHB2PT-33BGB	220 – 240	2500	50
DHB2PT-33B	208 – 240	2500	50/60				

Safety Information



WARNING

Indicates information important to the proper operation of the unit. Failure to observe may result in damage to the equipment and/or severe bodily injury or death.



CAUTION

Indicates information important to the operation of the unit. Failure to observe may result in damage to the equipment.

Installation

- A. Remove the unit from the carton and inspect for signs of damage. If there is damage to the unit:
 - notify the carrier within 24 hours of delivery
 - save carton and packaging materials for inspection purposes
 - contact your local dealer, or if purchased directly, the Prince Castle Sales Department at 800-722-7853 or 1-630-462-8800 to arrange for a replacement unit.

NOTE: When installing this unit, the ambient temperature at the mounting site should not exceed 100°F.

- B. Place the bin on a counter and seal the base to the counter with food-approved sealant.
- C. Plug the power cord into the bin and connect the plug into the proper electrical outlet. All connections must be in accordance with local electrical codes and any other applicable codes.

NOTE: The electrical receptacle should be a dedicated outlet. No other equipment should be operating on the line (refrigerators, fryers, etc.).

- D. If used, plug a Prince Castle external timer bar (consult factory for model) data cable into the blue plug jack (external) located on the rear of the Prince Castle holding bin. If cable from timer is too short, use Prince Castle Extender Cable Kit, P/N PC-COMEXT.
- E. Install the racks, pans and pan covers into the cavities.

- F. Turn the power switch to ON. Allow 30 minutes for warm-up.

NOTE: If the unit is to be networked with other Prince Castle units, an external timer may be connected to any one bin in the chain. Refer to CASTLENET COMMUNICATIONS NETWORK in this manual.

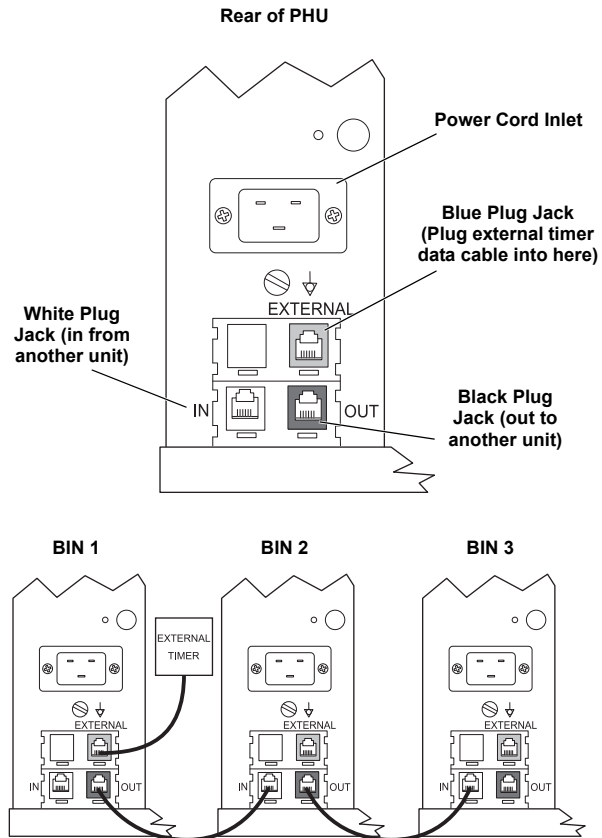

Prince Castle reserves the right to change specifications and product design without notice. Such revisions do not entitle the buyer to corresponding changes, improvements, additions or replacements for previously purchased equipment.

Operation

1 Turn power On/Off switch to ON position.

Load pan covers (if used) onto pan racks and insert racks into the unit.

Allow **30 minutes** for heaters to reach operating temperature. The Temperature Display will show temperature as unit warms up to the operating temperature.

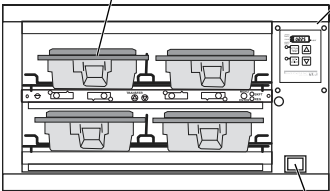

Power On/Off Switch

2 Press all PAN buttons.



The PAN DISPLAYS will show the assigned product name. If no product is assigned, the display will be dim and show "- - -". Pressing the PAN button will not activate the timer if "- - -" is displayed. Pressing PAN button when product name is displayed will start timing cycle.

BKFT (Breakfast) or REG (Regular Menu) will be lit depending on pre-programmed menu.

3 LED Timing Status



LED Timers

- RED (steady) = Ready for product
- RED (flashing) = Discard product
- GREEN (steady) = Oldest product, use first
- GREEN (flashing) = Cook more product
- YELLOW (steady) = Newer product, use green first
- YELLOW (flashing) = Cook more product

4 When LED is steady RED, load product and press the PAN button.

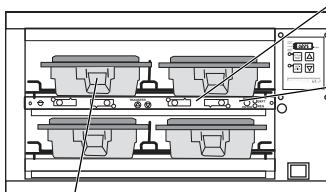

If no other pan is active for a product, the LED for the first pan loaded will turn from RED to GREEN.

The LED for the 2nd pan (3rd pan, etc.) loaded will turn from RED to YELLOW.

An LED timer can be stopped (cancelled) at any time by pressing and releasing the corresponding PAN button.

If only one pan is active for a product, the LED will turn from RED to GREEN.

5 When any of the timer LEDs flash, cook more product or remove and discard product as indicated.

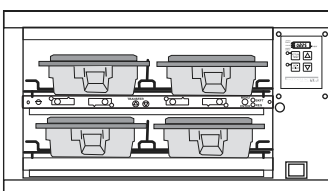

- GREEN (flashing) = Cook more product
- YELLOW (flashing) = Cook more product
- RED (flashing) = Discard product

WARNING
Hot surfaces.

6 Product, along with any remaining time, can be transferred from one cavity to another as follows:

- Press and release the TRANSFER button. Displays for available bins are brightly lit. Displays for bins currently timing, are dimly lit.
- Press and release the PAN button of the product to be moved.
- Press and release the TRANSFER button again.
- Move the product. Press and release the PAN button for the new location. The new location will finish timing the product. When the transferred pan timing expires, location will revert to original menu setting.



NOTE: If product transfer is not completed within a pre-programmed transfer time, the transfer will be cancelled. See your Manager.

Operation (continued)

7 To change a menu selection for a specific pan cavity, use the following steps:

- A. Press and hold the PRINCE CASTLE LOGO button for 6 seconds. All Pan displays will show PROG. All LED Timers will be RED.
- D. Press the UP or DOWN Arrow button to scroll to the desired product choice.
- E. Press the MENU/ENTER button to select the product choice.



- B. Press and hold the MENU/ENTER button. The display next to the MENU/ENTER button will display the product choices. While holding the MENU/ENTER button, press the UP or DOWN Arrow button to scroll through the product choices. While scrolling, the BKFT LED will be lit for the breakfast menus and the REG LED will be lit for the regular menus.
- C. Press a PAN button to change the product. the LED timer will change to yellow and the display will change from PROG to the assigned product choice and two other displays will change to up and down arrows and ENTR.
- F. Repeat Steps A – E as required for other Pan displays. Press the PRINCE CASTLE LOGO button to exit the Program Mode.
- NOTE: Up to six products may be programmed for each Pan button (1 for each menu). In addition, a pan may be set as "not used" by assigning "----" as its product.*

8 To shut down the unit, turn the power On/Off switch to OFF.

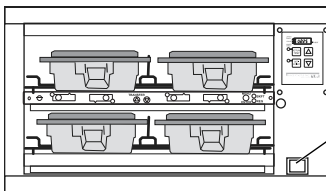

Cleaning

WARNING

Before performing any maintenance, turn the power switch to the OFF position and unplug the power cord from the electrical receptacle.

CAUTION

This unit is not watertight. Do not clean with a water jet/jet spray. Do not immerse the unit in water.

1. Turn the unit off and unplug the power cord from the electrical receptacle.
2. Remove the pan covers and pan racks. Wipe all parts and unit with a damp cloth. DO NOT use a green Scotch Bright pad cleaner, ice or water.

Setting the Temperature

- The unit has two shelves, each with an upper and lower heater (four heaters total).
 The factory pre-set for the upper heaters is 225°F.
 The factory pre-set for the lower heaters is 195°F.
 Each upper heater has a programmable range of 150° – 275°F.
 Each lower heater has a programmable range of 150° – 225°F.
 Use the control below and the following steps to set the setpoint temperature for each heater.

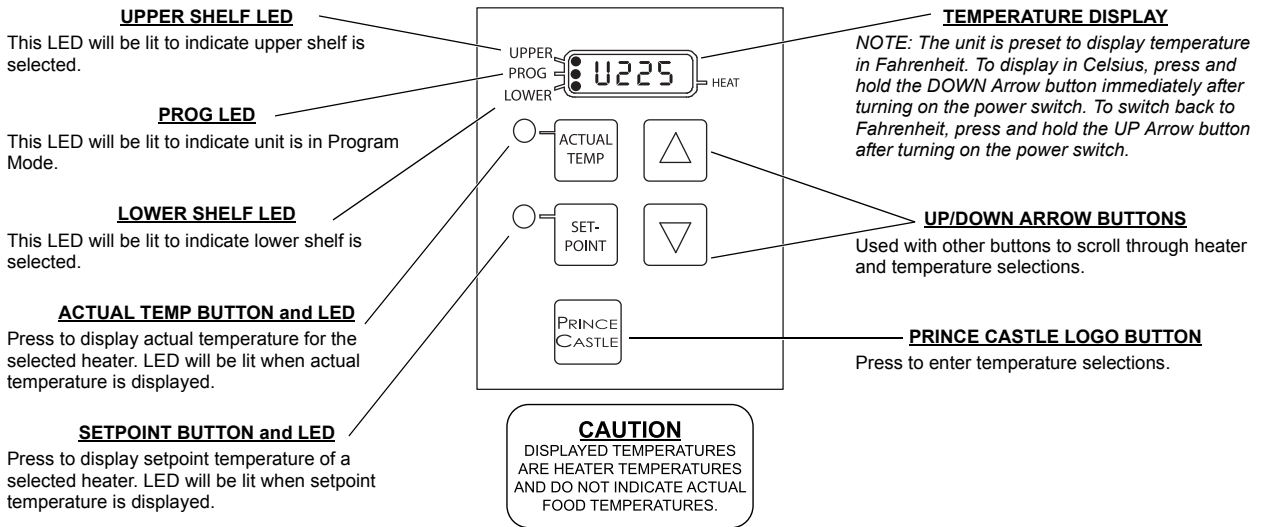

NOTE: To reset all times and temperatures to the factory settings, turn the unit off, then press and hold the UP and DOWN Arrow buttons simultaneously while turning the unit back on. A "P" will appear in the display and all times and temperatures will be reset to original factory settings.

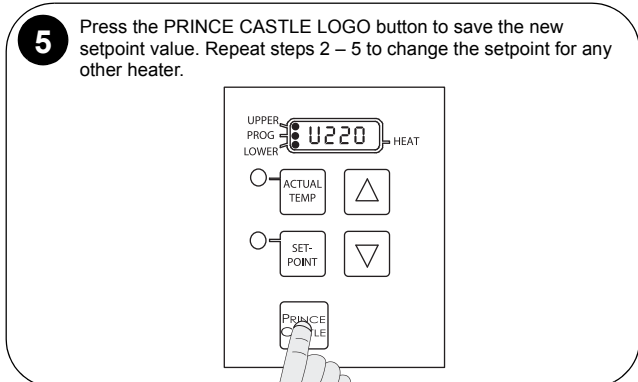
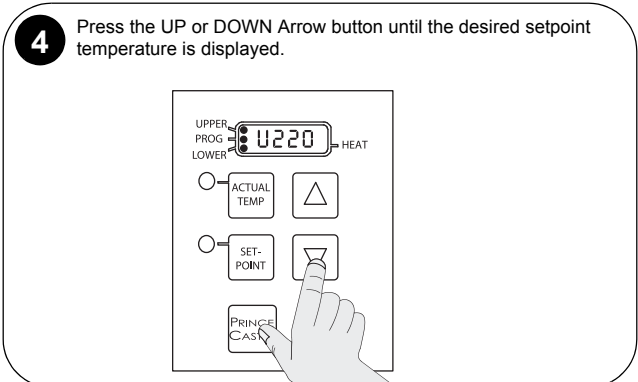
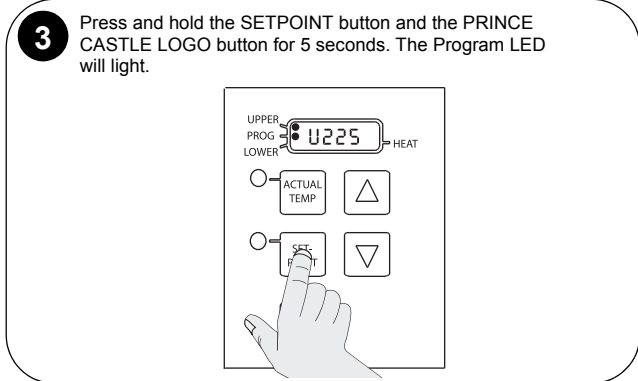
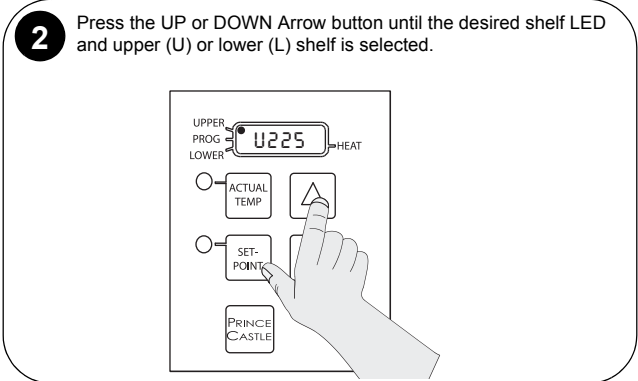

Calibrating Heaters

1 Use the following steps to calibrate the individual heaters.

NOTE: Allow sufficient amount of time for temperatures to stabilize before starting calibration.

Press the UP or DOWN Arrow button until the desired shelf LED and upper (U) or lower (L) heater is selected.

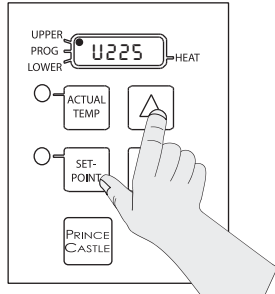

2 Take a temperature reading within the shelf near the center of the heater surface.

Use a stand-alone temperature meter (not supplied).

WARNING
Hot surfaces. Use caution when taking temperature readings within the shelf.

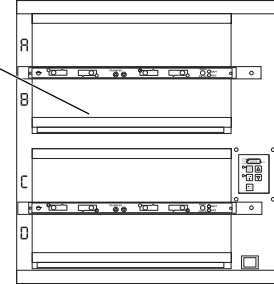

3 A. Press and hold the PRINCE CASTLE LOGO and ACTUAL TEMP buttons for 5 seconds. The colon (:) LED indicator will light. The temperature displayed is the actual heater temperature sensed by the controller.
B. To clear any offset readings, press the SETPOINT button.

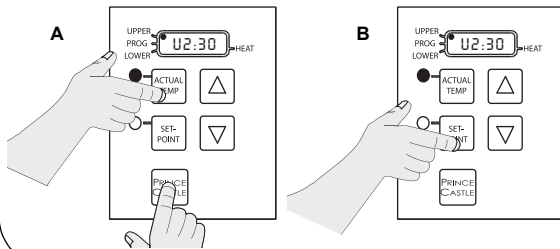

4 A. Press the UP or DOWN Arrow button until the temperature displayed matches the reading obtained in Step 2.
B. Press the PRINCE CASTLE LOGO button to save the temperature value and exit the Calibration Mode.

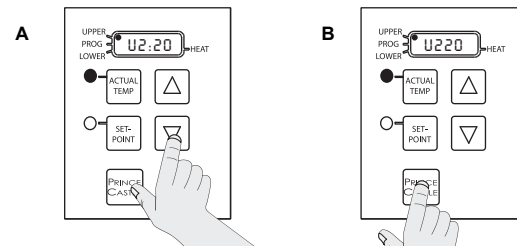

Selecting Breakfast and Regular Menus

1 There are six menus available:
BKFT LED ON = Menu1 or Menu6
REG LED ON = Regular2, Regular3, Regular4, or Regular5
Press and hold the MENU/ENTER button, then use the UP or DOWN Arrow button to scroll through the 6 menus.

When scrolling, menu numbers appear in this display.



2 When the desired menu is displayed, release the MENU/ENTER button. The food products for the menu will be displayed in the upper and lower PAN displays.

When timers for a different menu are still active, those BKFT or REG LEDs will flash until they are all cancelled.

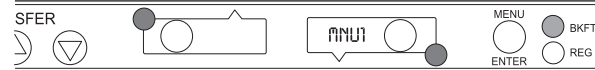

Programming the Menus

1 Press and hold the PRINCE CASTLE LOGO button (on the button bar) until all the displays show PROG and the PAN buttons LEDs all glow RED.

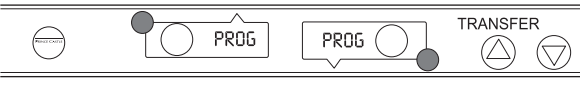

2 Press and hold the MENU/ENTER button. The display next to the MENU/ENTER button will show the menu choices. Use the UP or DOWN Arrow button to scroll through the 6 menus. Release the MENU/ENTER button when the desired menu is displayed.

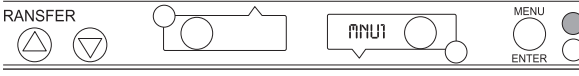

When the MENU/ENTER button is released, all displays will again show PROG.



3 A. Press the PAN button next to the display to be changed. The LED will change from RED to YELLOW and the display will change from PROG to the assigned product choice.



B. Press the UP or DOWN Arrow button to scroll to the desired product choice.

C. Press the MENU/ENTER button to save the selection. All displays will show PROG.



4 A. Repeat Steps 2 and 3 as required.

B. Press the PRINCE CASTLE LOGO button to exit the Program Mode and return to the Run Mode.

NOTE: Up to six items (one for each menu) may be programmed for each PAN button. A pan may be set as "not used" by assigning "----" as its product.



Changing the Hold and Cook-More Times

1 A. The SET PRODUCT TIME menu is used to change the Hold and Cook-More times.

B. Press and hold the PRINCE CASTLE LOGO button, then immediately press and hold the MENU/ENTER button until the display shows one of the programming menus.

C. Use the UP or DOWN Arrow button to scroll to the PROD TIME ↑ ↓ ENTR menu. (*NOTE: Units with 6 or 8 pan displays will show SET PRODUCT TIME ↑ ↓ ENTR.*)

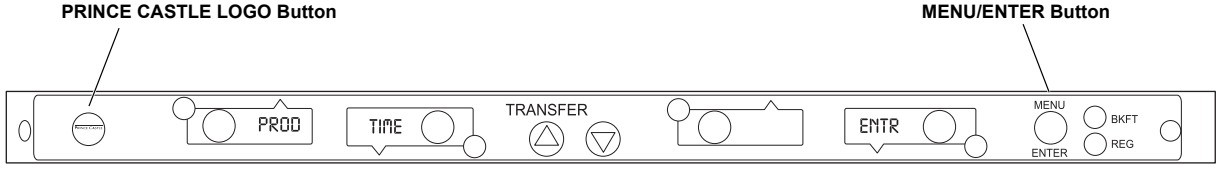

Changing the Hold and Cook-More Times (continued)

- 2** A. Press and release the MENU/ENTER button to enter the Set Product Time menu. The display will show, for example, EGGS TIME ↑ ↓ ENTR.
- B. Use the UP or DOWN Arrow button to scroll through the list of products. When the desired product is displayed, press the MENU/ENTER button to select it.

Refer to the Product Menu Details on page 12 for a list of products and their corresponding display names.



NOTE: Holding the UP or DOWN Arrow button for longer than 2 seconds will cause the product list to automatically scroll up or down.

- 3** A. The display now shows the current Hold time.



- B. Use the UP or DOWN Arrow button to scroll to the desired Hold time. When the desired Hold time is displayed, press the MENU/ENTER button to save the desired Hold time.



NOTE: Hold time cannot be reduced to less than the Cook-More time plus one minute.

- 4** A. The display will now show current Cook-More time. Use the UP or DOWN Arrow button to scroll to the desired Cook-More time.



- B. When the desired Cook-More time is displayed, press the MENU/ENTER button to save it.



NOTE: Cook-More time cannot be increased to more than the Hold time minus one minute.

- 5** A. The display will show PROD TIME ENTR. Repeat Steps 2 – 4 for any other product.

- B. Press and release the PRINCE CASTLE LOGO button at any time to exit the Program Mode and return to the Run Mode.

NOTE: If the MENU/ENTER button has not been pressed to save any changes, the program will revert to the original values.



Setting the Alternating Display Interval

- A. The Alternating Display Interval allows the timer bar displays to alternate between the product name and remaining Hold time. The default setting is 5 seconds.
- B. Press and hold the PRINCE CASTLE LOGO button, then immediately press and hold the MENU/ENTER button until the display shows one of the programming menus.
- C. Use the UP or DOWN Arrow button to scroll to the DISP ALT TIME menu. Press MENU/ENTER button.
- D. Use the UP and DOWN Arrow buttons to adjust the interval setting from 0 to 15 seconds. Press MENU/ENTER to save the change.
- E. Press and hold the PRINCE CASTLE LOGO button at any time to exit the Program Mode.

PRINCE CASTLE LOGO Button

MENU/ENTER Button



Changing Product Names

- 1** A. The EDIT PRODUCT NAME menu is used to change a default product name to one of your own choosing.
 B. Press and hold the PRINCE CASTLE LOGO button, then immediately press and hold the MENU/ENTER button until the display shows one of four programming menus.
 C. Use the UP or DOWN Arrow button to scroll to the PROD NAME ↑ ↓ ENTR menu.
NOTE: The default names available for editing are listed on page 12.

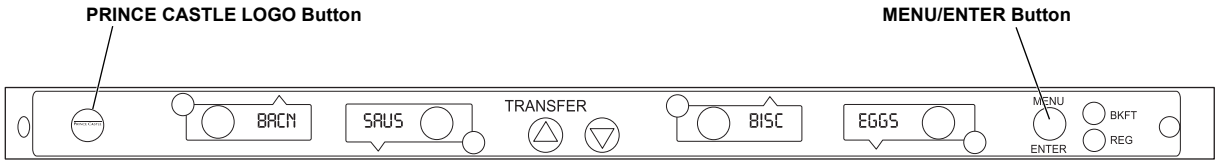

- 2** A. Press and release the MENU/ENTER button to enter the Edit Product Name menu. The display will read PROD XXXX ↑ ↓ ENTR.
 B. Use the UP or DOWN Arrow button to scroll through the list of products.
 C. When the desired product is displayed, press the MENU/ENTER button to select it. The first letter (in this case, the E) will start blinking.

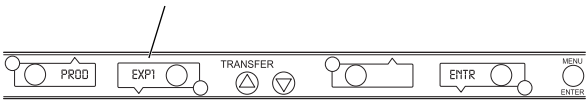

- 3** A. To change the blinking E, use the UP or DOWN Arrow button to scroll to the desired letter/number/symbol.
 B. When the desired selection is displayed, press the PAN button (to the left or right of the selected display) to move to the next digit.
 C. Repeat for all digits.



NOTE: Holding the UP or DOWN Arrow button for longer than 2 seconds will cause the selected digit to automatically scroll up or down.

- 4** When all four digits have been changed, press the MENU/ENTER button to save the new name.



- 5** A. The display will show PROD NAME ↑ ↓ ENTR. Repeat Steps 2 – 4 for any other product.
 B. Press and release the PRINCE CASTLE LOGO button at any time to exit the Program Mode and return to the Run Mode.
NOTE: If the MENU/ENTER button has not been pressed to save any changes, the program will revert to the original names.



Set Maximum Transfer Time

- 1** A. The SET MAXIMUM TRANSFER TIME menu is used to set the amount of time allowed to make a product transfer from one pan to another.
B. Press and hold the PRINCE CASTLE LOGO button, then immediately press and hold the MENU/ENTER button until the display shows one of the programming menus.
C. Use the UP or DOWN Arrow button to scroll to the XFR TIME ↑ ↓ ENTR menu. (*NOTE: Units with 6 or 8 pan displays will show MAX XFR TIME ↑ ↓ ENTR.*)



- 2** A. Press and release the MENU/ENTER button to enter the Set Maximum Transfer Time menu.
B. The display shows XFR :20 ↑ ↓ ENTR. This shows a value of 20 seconds.



- 3** A. To change the time, use the UP or DOWN Arrow button to scroll to the desired time. When the desired selection is displayed, press the MENU/ENTER button to enter the selection.
B. Press and release the PRINCE CASTLE LOGO button at any time to exit the Program Mode and return to the Run Mode.
NOTE: If the MENU/ENTER button has not been pressed to save any changes, the program will revert to the original time.

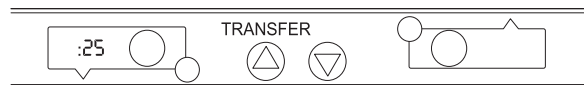

Set Volume Level

- 1** A. The default setting for the volume level is OFF.
B. Press and hold the PRINCE CASTLE LOGO button, then immediately press and hold the MENU/ENTER button until the display shows one of the programming menus.
C. Use the UP or DOWN Arrow button to scroll to the Set Vol 0 ↑ ↓ ENTR menu.

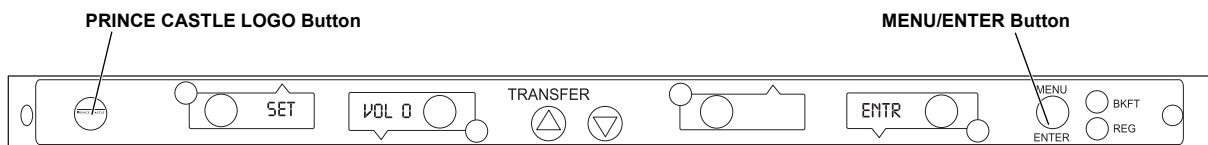

- 2** A. Press and release the MENU/ENTER button to enter the Set Volume menu.
B. The display shows SET VOL 0 ↑ ↓ ENTR. This shows that the volume is currently turned off.
The volume may be set for Vol 0 (off) or for volume levels Vol 1 through Vol 3.

- 3** A. To change the volume level, use the UP or DOWN Arrow button to scroll to the desired level. When the desired selection is displayed, press the MENU/ENTER button.
B. Press and release the PRINCE CASTLE LOGO button at any time to exit the Program Mode and return to the Run Mode.
NOTE: If the MENU/ENTER button has not been pressed to save any changes, the program will revert to the original volume level.

CastleNet® Communications Network

The Prince Castle DHB Bins, external timers, and New Bun Cabinet Timers can be inter-connected to form the CastleNet® Communication Network. The network can be used for data transfer between bins and timers for menu updates or to transfer product hold time from bin-to-bin. A PDA (or similar device) or a notebook with Prince Castle MenuView® software is used to connect to the network and enter the desired changes.

Each bin is supplied with a standard 25' cable and allows units to be "daisy-chained" together to form the network. If cable is too short, use Prince Castle Extender Cable Kit, P/N PC-COMEXT.

The factory default address for Main bins and timers is address 1. The factory default address for Specialty bins and timers is address 2. If a third bin is used, the address must be set at 3.

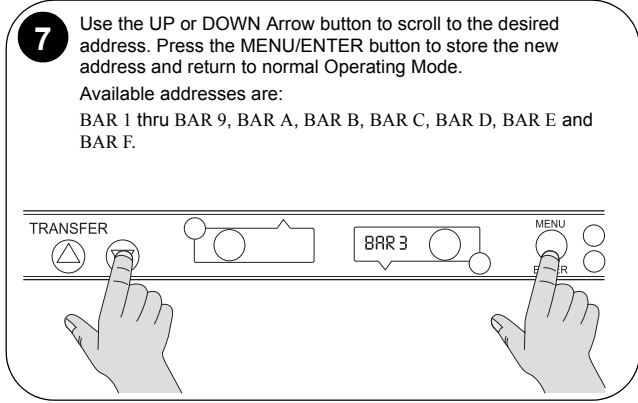
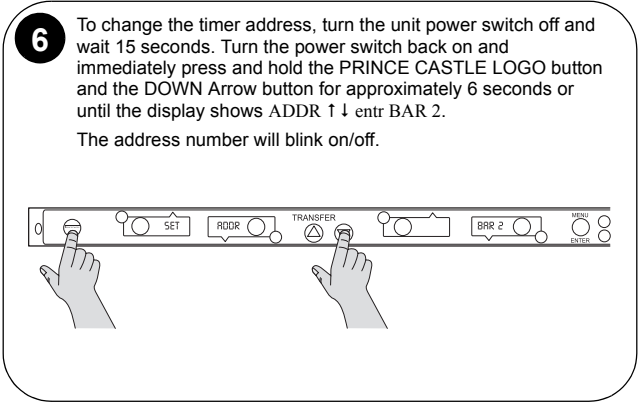
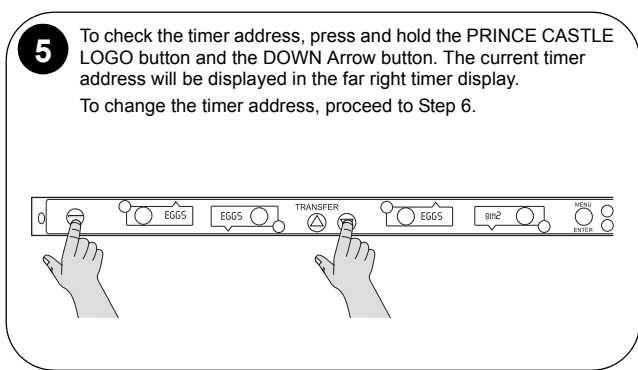
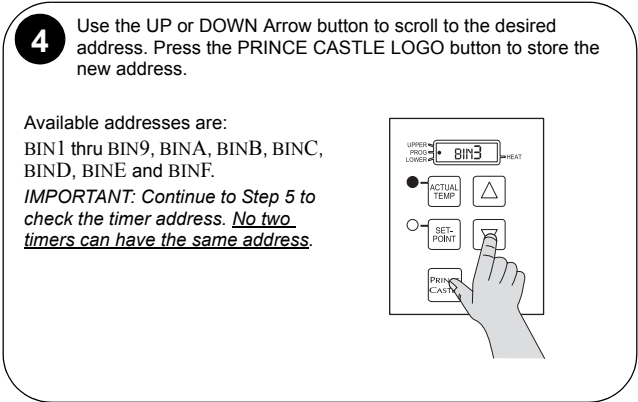
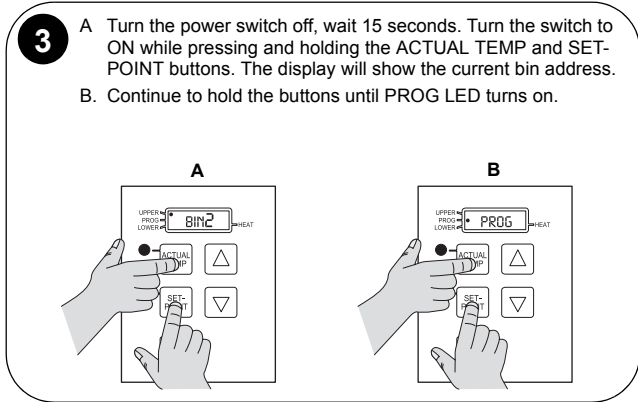
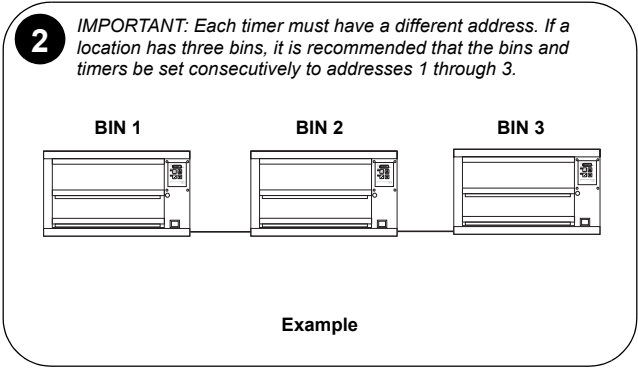
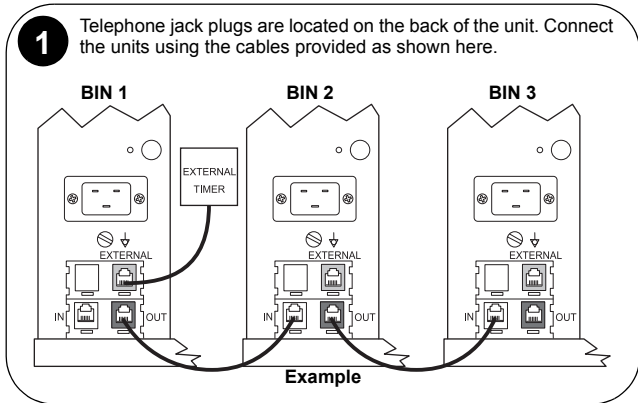

Factory Presets

Product Menu Details

Product	Display Name	Hold Minutes ¹	Cook-More Minutes ¹
Burger	BUR1	30	3
Burger	BUR2	30	3
Chicken Patty	CHX1	30	3
Chicken Patty	CHX2	30	3
Chicken Patty	CHX3	30	3
Chicken Wing	WING	30	3
Fish	FISH	30	3
Eggs	EGGS	30	3
Sausage	SAUS	30	3
Bacon	BACN	30	3
Ham	HAM	30	3
Popper	POP	30	3
Mozzarella Stick	MOZ	30	3
Onion	ONIN	30	3
Mushroom	MUSH	30	3
Chicken Nuggets	NUGG	30	3
Spicy Chicken	SPCY	30	26
French Toast	TOST	10	8
Chicken Stars	STAR	30	27
Large	LRG	20	17
\$6 Burger	SIX	20	17
BBQ Chicken	BBQ	20	17
Crispy Chicken	CRSP	30	26
Special #1	SPC1	30	3
Special #2	SPC2	30	3

1. Hold and Cook-More times may be re-programmed. See page 7.

2. Product abbreviations SPC1 thru SPC9 may be reprogrammed. See page 9.

Menu	Bkft	Down	Up	Down	Up	Down	Up	Down	Menu	LED
	CRSP	ONIN	BBQ	SPCY	SIX	SIX	LRG	LRG	MNU1	Bkft
	BUR1	BUR1	BUR1	BUR1	BUR2	BUR2	BUR2	BUR2	MNU2	REG
	CHX1	CHX1	CHX2	CHX2	CHX3	CHX3	WING	FISH	MNU3	REG
	CHX1	CHX2	WING	WING	MOZ	MOZ	POP	POP	MNU4	REG
	CHX1	CHX2	CHX3	WING	WING	POP	ONIN	MUSH	MNU5	REG
	EGGS	EGGS	EGGS	EGGS	HAM	BACN	SAUS	SAUS	MNU6	Bkft

6 Channel Menus

Timer	6	5	4	3	2	1		
	STAR	FISH	TOST	ONIN	CRSP	SPCY	MNU1	Bkft
	BUR1	BUR1	BUR1	BUR2	BUR2	BUR2	MNU2	Reg
	CHX1	MUSH	MOZ	POP	WING	WING	MNU3	Reg
	CHX1	CHX2	WING	MOZ	POP	POP	MNU4	Reg
	CHX1	CHX2	CHX3	POP	ONIN	MUSH	MNU5	Reg
	EGGS	EGGS	EGGS	HAM	BACN	SAUS	MNU6	Bkft

Troubleshooting

PROBLEM	PROBABLE CAUSE	SOLUTION
Display flashes Opn and rEL.	Open relay. Circuit inoperable.	Replace power circuit board.
Display flashes SHr and rEL.	Shorted relay. Circuit inoperable. Open heater. Unplugged ribbon cable between power and main circuit boards.	Replace power circuit board. Test heater resistance (150.2 Ohms). Replace heater if necessary. Verify ribbon cable connection.
Display flashes Opn and rEL.	Temperature is below 75°F. Heater inoperable. Probe inoperable. Relay inoperable.	Normal display during warmup. Test heater resistance (150.2 Ohms). Check for open thermocouple wires from probe. Replace heater/probe assembly. Replace power circuit board.
Display shows HHH for an extended period of time and heater surface temperature is hot.	Temperature is above 300°F (abnormal operation).	Diagnostic circuit inoperable. Replace power circuit board.
Display shows HHH for an extended period of time and heater surface temperature is cool.	Probe is inoperable.	Check for pinched thermocouple wires from probe. Replace heater/probe assembly.

Exploded View and Parts List (DHB2PT-20B)

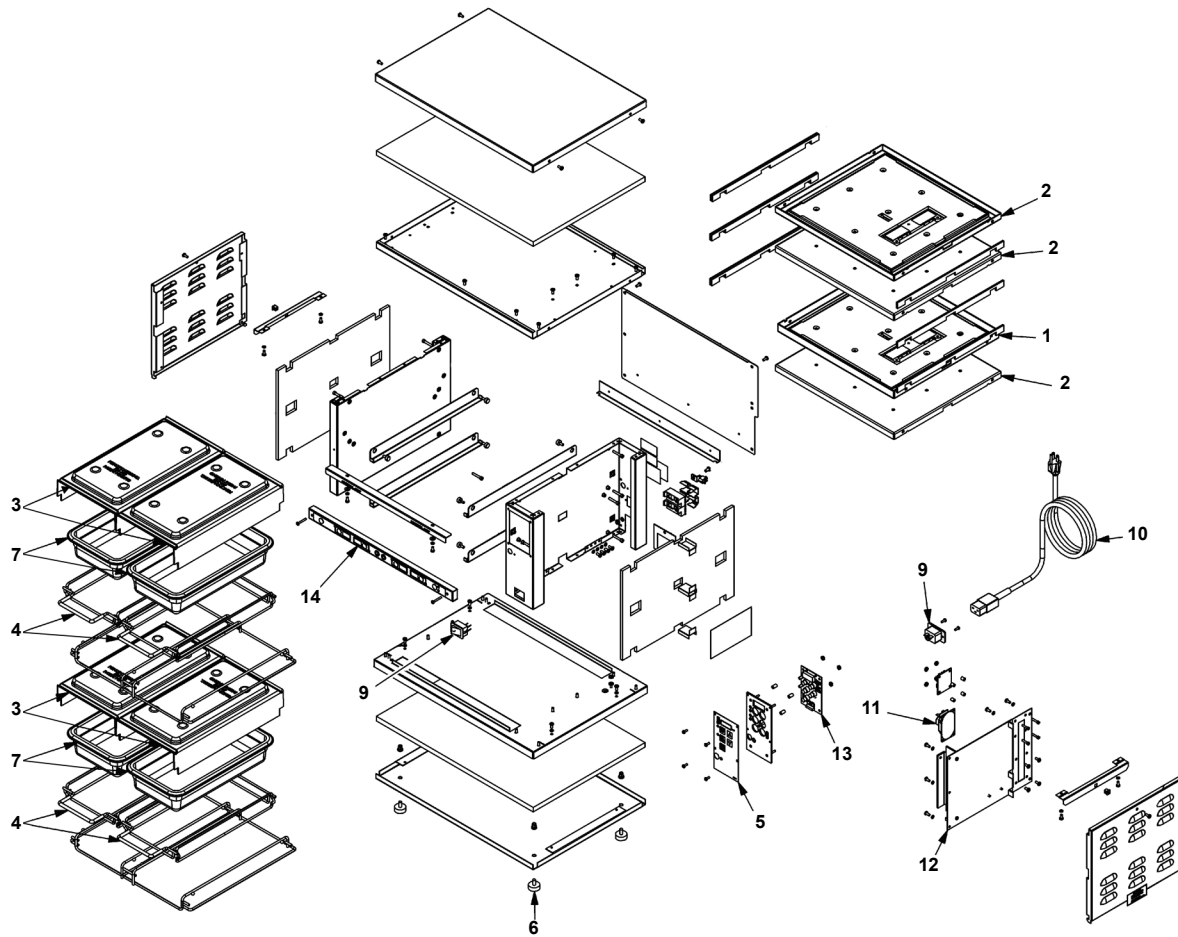

Ref.	Part No.	Description
1	542-121S	Upper Heater Assy
2	542-059S	Lower Heater Assy
3	541-723E4S	Cover (Pkg of 4)
4	541-725S	Rack Kit
5	536-802S	Overlay Kit
6	197-232S	Mounting Foot (Pkg of 4)
7	155695N-4	Pan (Pkg of 4)
8	78-184S	Power Switch
9	88-609S	Power Connector

Ref.	Part No.	Description
10	72-200-15S	Power Cord
11	541-959S	PCB Audio Interface Kit
12	541-734S	Main PCB Kit
13	541-719S	Display PCB Kit
14	541-999S	Timer Bar Kit
Not Shown*		
*	541-1000S	Auxiliary Timer Bar
*	88-709-2-11S	Speaker

Exploded View and Parts List (DHB2PT-27B/-27BCE)

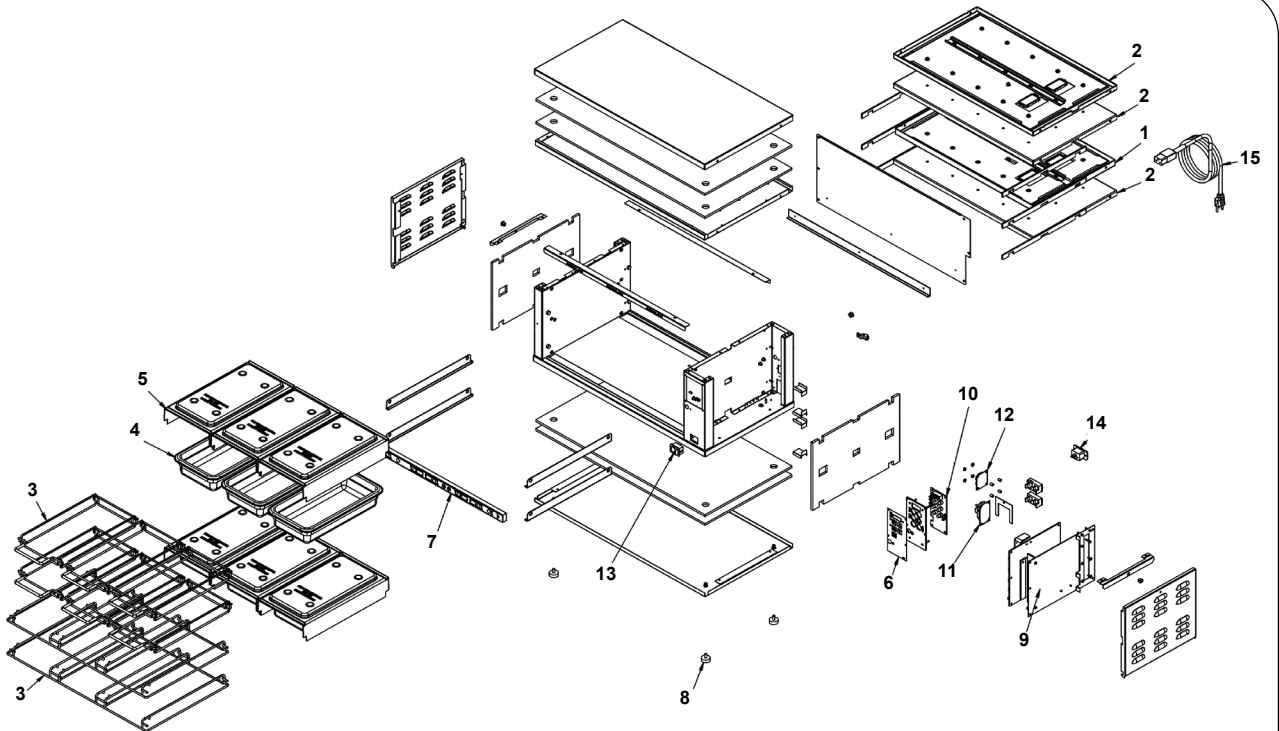

Ref.	Part No.	Description
1	541-833S	Upper Heater Kit (DHB2PT-27B)
	541-669S	Upper Heat Assembly (DHB2PT-27BCE)
2	541-832S	Lower Heater Kit (DHB2PT-27B)
	541-695S	Lower Heater Assembly (DHB2PT-27BCE)
3	541-724S	Rack Kit
4	155695N-4	Pan (Pkg of 4)
5	541-723E4S	Cover (Pkg of 4)
6	536-802S	Display Overlay Kit
7	541-997S	Timer Bar Kit
8	197-232S	Mounting Foot (Pkg of 4)
9	541-734S	Main PCB Kit

Ref.	Part No.	Description
10	541-719S	Display PCB Kit
11	88-709-2-11S	Speaker Kit
12	541-959S	PCB Audio Interface Kit
13	78-184S	Power Switch
14	88-609S	Power Inlet Connector (DHB2PT-27B)
	88-720-01S	Power Inlet Connector (DHB2PT-27BCE)
15	72-200-15S	Power Cord (DHB2PT-27B)
	72-230S	Power Cord (DHB2PT-27BCE)
Not Shown*		
*	541-734S	Control PCB (DHB2PT-27B)
*	541-735S	Control PCB (DHB2PT-27BCE)

Exploded View and Parts List (DHB2PT-33B)

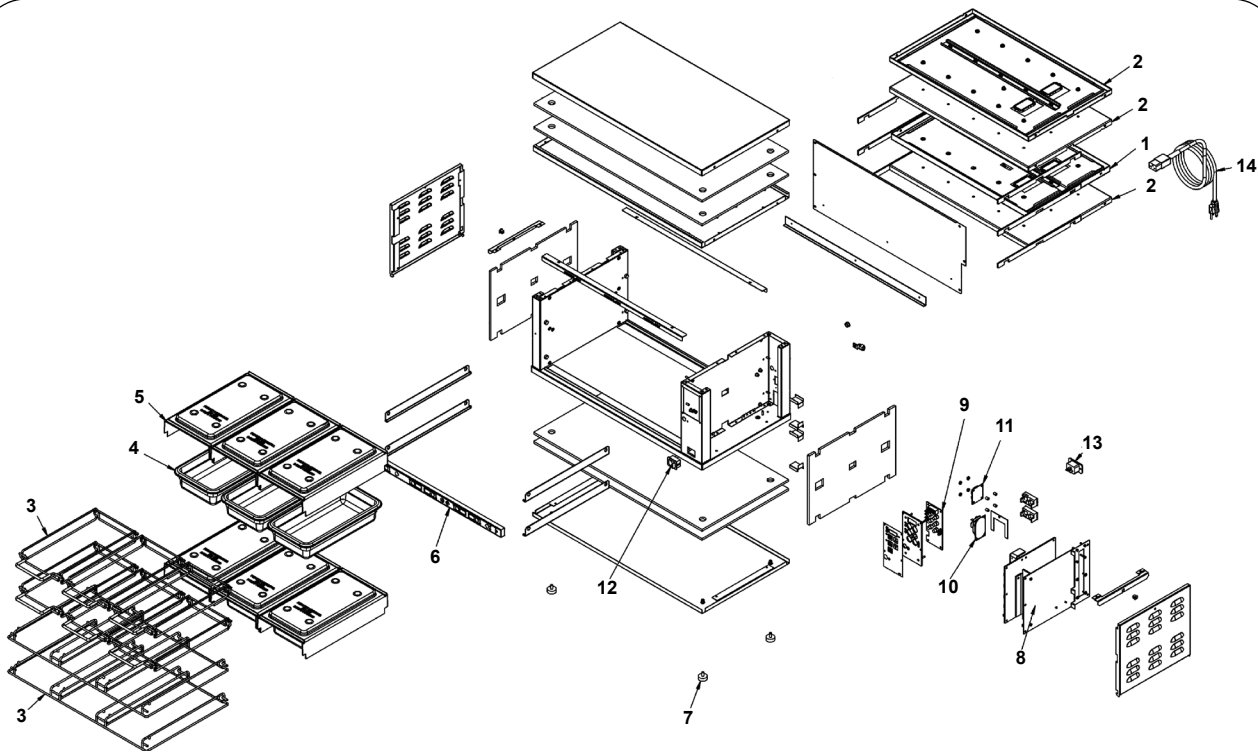

Ref.	Part No.	Description	Ref.	Part No.	Description
1	541-376S	Upper Heater Kit	8	541-735S	Main PCB Kit
2	541-375S	Lower Heater Kit	9	541-719S	Display PCB Kit
3	541-636S	Rack Kit	10	88-709-2-11S	Speaker Kit
4	155695N-4	Pan (Pkg of 4)	11	541-959S	PCB Audio Interface Kit
5	541-723E4S	Cover (Pkg of 4)	12	78-184S	Power Switch
6	541-995S	Timer Bar Kit	13	88-609S	Power Inlet Connector
7	197-232S	Mounting Foot (Pkg of 4)	14	72-200-15S	Power Cord

Note: DHB2PT-33B has 4 pans.

