

Operation Manual

Product Holding Bin
DHB3PT-41A/30
(with Prince Castle Button Bar)



LIMITED WARRANTY

This product is warranted to be free from defects in material and/or workmanship for a period of 1 years from date of original installation, not to exceed 24 months from the date of manufacture.

Any component which proves to be faulty in material and/or workmanship will be replaced or repaired (at the option of Prince Castle, Inc.) without cost to the customer for parts and labor. This warranty covers on location service (i.e. trip charges and or mileage). Travel mileage is limited to 100 miles (200 Kilometers) round trip (one trip warranty) from an authorized service agency or its sub-service agency.

This warranty is subject to the following exceptions/conditions:

- Use of any non-genuine Prince Castle parts voids this warranty.
- All labor to be performed during regular work hours. Overtime premium (the incremental amount) will be charged to the customer.
- Damage caused by carelessness, neglect and/or abuse (e.g., dropping, tampering or altering parts, equipment damaged in shipment, by fire, flood or an act of God) is not covered under this warranty.
- All problems due to operation at voltages other than that specified on equipment nameplates are not covered by this warranty. Conversion to correct voltage is the customer's responsibility.
- This equipment must be serviced by Prince Castle Authorized Service Agency or a Prince Castle Service Technician during the warranty period.

TABLE OF CONTENTS

Safety Information	2
Electrical Specifications	2
Product Identification	2
Installation	3
Operation	3
Cleaning	5
Setting the Temperature	6
Calibrating Heaters	9
Selecting Breakfast and Regular Menu	10
Programming the Menu	10
Changing the Hold and Cook-More Times	11
Changing Product Names	12
Factory Presets	13
Troubleshooting	16
Wiring Diagram	16
Exploded View and Parts List	17

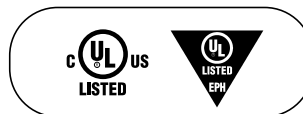

PRINCE CASTLE LLC
WORLDWIDE



A Marmon Group / Berkshire Hathaway Company

205 Lies Rd. • Carol Stream, IL 60188 USA Telephone:
630-462-8800 • Toll Free: 1-800-PCASTLE Fax:
630-462-1460 • www.princecastle.com

Safety Information

⚠ WARNING

Indicates information important to the proper operation of the unit. Failure to observe may result in damage to the equipment and/or severe bodily injury or death.

⚠ CAUTION

Indicates information important to the operation of the unit. Failure to observe may result in damage to the equipment.

Electrical Specifications

Model No.	Volts	Watts	Hz
DHB3PT-41A	208 – 240	4278– 5700	50/60
DHB3PT-30	208 – 240	4278– 5700	50/60

Product Identification

Components

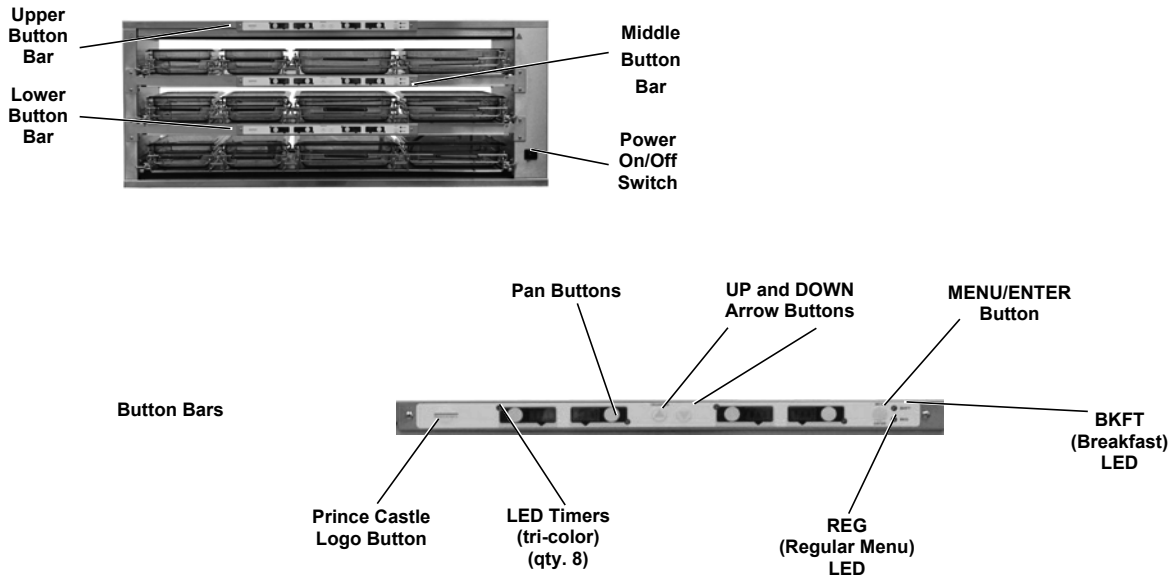

Important

Prince Castle reserves the right to change specifications and product design without notice. Such revisions do not entitle the buyer to corresponding changes, improvements, additions or replacements for previously purchased equipment.

Installation

Remove the unit from the carton and inspect for signs of damage. If there is damage to the unit:

- notify the carrier within 24 hours of delivery
- save carton and packaging materials for inspection purposes
- contact your local dealer, or if purchased directly, the Prince Castle Sales Department at 800-722-7853 or 1-630-462-8800 to arrange for a replacement unit.

NOTE: When installing this unit, the ambient temperature at the mounting site should not exceed 100°F (38°C).

Plug the power cord into the proper electrical receptacle. All electrical connections must be in accordance with local electrical codes and any other applicable codes.

WARNING

All electrical connections must be in accordance with local electrical codes and any other applicable codes.

If the supply cord is damaged, it must be replaced by the manufacturer, its service agent, or similarly qualified persons in order to avoid a hazard.

To prevent an electric shock hazard this device must be bonded to equipment in close proximity with an equipotential bonding conductor. This device is equipped with a grounding lug for this purpose and is marked with the following symbol.



Operation

WARNING

This application is not intended for use by persons (including children) with reduced physical, sensory, or mental capabilities, or lack of experience and knowledge unless they have been given supervision or instruction concerning use of the appliance by a person responsible for their safety.

- 1 Turn power On/Off switch (A) to ON position.

Load pan covers (if used) onto pan racks and insert racks into the unit.

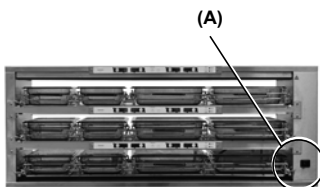

Allow 20 minutes for heaters to reach operating temperature.

- 2 Press all PAN buttons.
The PAN displays will show the assigned product name.

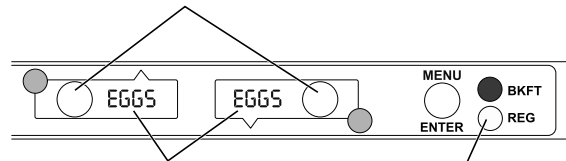

If no product is assigned, the display will be dim and show "----". Pressing the PAN button will not activate the timer if "----" is displayed. Pressing PAN button when product name is displayed will start timing cycle.

BKFT (Breakfast) or REG (Regular Menu) will be lit depending on pre-programmed menu.

- 3 LED Timing Status



LED Timers

- RED (steady) = Ready for product
- RED (flashing) = Discard product
- GREEN (steady) = Oldest product, use first
- GREEN (flashing) = Cook more product
- YELLOW (steady) = Newer product, use green first
- YELLOW (flashing) = Cook more product

- 4 When LED is steady RED, load product and press the PAN button.
If more than one pan is active for a product, the LED for the first pan loaded will turn from RED to GREEN.



The LED for the 2nd pan loaded with the same product will turn from RED to YELLOW.

An LED timer can be stopped (cancelled) at any time by pressing and releasing the corresponding PAN button.

If only one pan is active for a product, the LED will turn from RED to GREEN.

Operation (continued)

- 5** When any of the timer LEDs flash, cook more product or remove and discard product as indicated.



GREEN (flashing) = Cook more product
YELLOW (flashing) = Cook more product
RED (flashing) = Discard product



WARNING

Hot surfaces.

- 6** To change a menu selection for a specific pan cavity, use the following steps:

- A. Press and hold the PRINCE CASTLE LOGO button for 6 seconds. All PAN displays on the button bar will show PROG. All LED Timers on the button bar will be RED.
- D. Press the UP or DOWN Arrow button to scroll to the desired menu item.
- E. Press the MENU/ENTER button to select the menu item.



- B. Press and hold the button bar's MENU/ENTER button. The display next to the MENU/ENTER button will display the menu choices. While holding the MENU/ENTER button, press the UP or DOWN Arrow button to scroll through the menu choices.
- C. Press a PAN button to change the menu. The LED Timer will change to YELLOW and the display will change from PROG to the assigned menu item.
- F. Repeat steps A – E as required for other PAN displays. Press the PRINCE CASTLE LOGO button to exit the Program Mode.

NOTE: Up to six menu items may be programmed for each PAN button. In addition, a pan may be set as "not used" by assigning "----" as its product.

Operation (continued)

- 7** To shut down the unit, turn the power On/Off switch (A) to OFF.

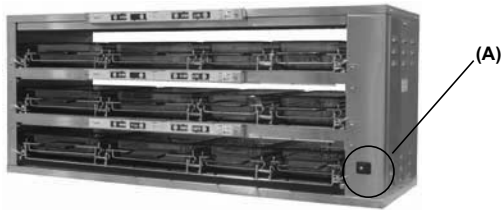

Cleaning

 **WARNING**

Before performing any maintenance, turn the power switch to the OFF position and unplug the power cord from the electrical receptacle.

 **CAUTION**

This unit is not watertight. Do not clean with a water jet/jet spray. Do not immerse the unit in water.

1. Turn the unit off.
2. Remove the pan covers and pan racks. Wipe all parts and unit with a damp cloth. DO NOT use a green Scotch Bright pad cleaner, ice or water.

Heater Temperatures

The bin heater temperature display and control have been incorporated into the POSA Main time bar of the Popeye's DHB3PT-41 bin. This bin has three Main timer bars on the front. Figure 1 shows the default bar positions POSA, POSB, and POSC. Refer to the Timer Bar Positions below. The timer bar set for position POSA control the bin heaters. The timer bars for positions POSB and POSC do not have heater control.

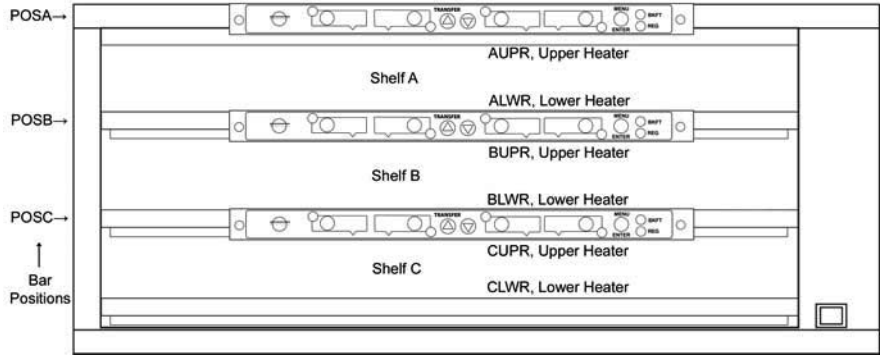

Figure 1

Note: These instructions are only for the bar set to position POSA.

On the Main timer bar, press the Prince Castle Logo and the Down Arrow buttons together and release. The displays will show temperature information for the uppermost heater as show in Table 1 below. The temperatures show are examples only.

Table 1

Set Temperature	Actual Temperature	Heater Location	Heater Indicator
225S	224A	AUPR	↕ H

Set Temperature: The current temperature goal for the displayed heater

Actual Temperature: The current actual temperature for the displayed heater.

Heater Location: This is the heater location within the bin shelf being displayed. Each heater extends to the entire width and depth of the shelf.

Heat Indicator: H will be shown when the bin controller has turned on the heater. H will flash when a fault condition exists for the displayed heater.

To display information for the other heaters in the bin, press the Up or Down Arrow buttons to scroll through each heater display. Table 2 show the heater information that will be displayed. The temperatures and Heat Indicator displays show are examples only.

Table 2

Set Temperature	Actual Temperature	Heater Location	Heater Indicator
225°F	226°F	AUPR	↕
195°F	196°F	ALWR	↕
225°F	227°F	BUPR	↕
195°F	197°F	BLWR	↕
225°F	224°F	CUPR	↕ H
195°F	194°F	CLWR	↕ H

Heater fault indications will be displayed instead of an actual temperature in a heater error condition exists. These indications are:

Open Relay: Actual Temperature display alternates between OPEN and RELY

Shorted Relay: Actual Temperature display alternates between SHRT and RELY

High Temperature: Actual Temperature display shows HHHH

These fault indicators will be accompanied by the Heat Indicator display flashing H.

The Actual Temperature display will show LLL (low temperature) if the heater temperature is below 75°F, such as during warm-up.

Setting the Temperature (continued)

Cancel Heater Display:

To cancel the heater display and go back to normal timer displays, press the Prince Castle Logo and the Up Arrow buttons together and release. The displays will return to showing product names or remaining time if a timer is running. Also, the heater display will cancel itself after 20 seconds of no button presses

Changing Set Point Temperatures for Heaters:

Note: The upper and lower heaters in each shelf extend to the entire width and depth of the shelf.

1. Go to the heater display on the Main timer bar by pressing the Prince Castle Logo and the Down Arrow buttons together and release.
2. Press and hold the Prince Castle Logo button and then press and hold timer 4 button (4th timer button to the left of the Menu/Enter button.) Hold both for 6 seconds. The display will change to heater selection mode. For example:

Set Temperature	SEL	Heater Location	Heater Indicator
225°F		AUPR	↑↓

3. Press the Up and Down Arrow buttons to scroll to the shelf and heater to be changed.
4. Press the Menu/Enter button. The display will change to set temperature mode:

Set Temperature	SET	Heater Location	Heater Indicator
225°F		AUPR	↑↓

5. Use the Up and Down Arrow buttons to scroll to the desired heater set point temperature. To turn off the heater, scroll down until OFF is displayed.
6. Press the Menu/Enter button. The display changes back to select heater mode.
7. Repeat steps 3 to 6 for changes to other heaters.
8. Press the Logo button when finished with heater set point temperature changes. The display will return to the heater display.
9. Press the Logo and Up Arrow buttons together and release to return to the normal timer display. Also, the heater display will cancel itself after 20 seconds of no button presses.

Setting the Temperature (continued)

Calibrating Heater Offset:

This program menu item is only available in the bar set for POSA.

Note: Allow a sufficient amount of time for temperatures to stabilize before starting calibration.

Measuring temperature:

1. View the actual heater temperatures as described above.
2. Using stand-alone temperature meter (not supplied), take a temperature reading within the shelf near the center of the heater surface.
3. If the actual temperature displayed by the timer bar does not closely match the meter, the displayed temperature can be adjusted as follows.

Adjusting the temperature display:

1. On the Main timer bar, press and hold the Prince Castle Logo and Menu/Enter buttons together for 6 seconds. The display will change to program mode.
2. Use the Up and Down Arrow buttons to scroll to the CAL HTRS display.
3. Press the Menu/Enter button. The display will show SEL AUPR for shelf A, upper heater.
4. Use the Up and Down Arrow buttons to scroll to the heater to adjust. The display will cycle through heaters AUPR, ALWR, BUPR, CUPR and CLWR> See Figure 1 above for shelf and heater locations.
5. Press the Menu/Enter button. The display will show CAL AUPR (if AUPR was chosen) and the actual temperature number. This number may fluctuate by a degree since it is the actual temperature reading.
6. Press and release the Up or Down Arrow buttons to increase or decrease the displayed temperature number. The number can be increased by up to 20 degrees, or decreased by up to 20 degrees. The display may not change instantly. For example, if the display shows 200 and the handheld meter shows 205, press the Up Arrow button 5 times. The display will increment for the number of button pushes until it shows 205. This number may fluctuate by a degree since it is the actual temperature reading.
7. Press the Menu/Enter button. The display will go back to CAL HTRS again.
8. Repeat this process for the other heaters.
9. Press the Prince Castle Logo button when done. The bar will return to normal operating mode.

Changing the Temperature Degree Scale:

This program menu item is only available in the bar set for POSA.
Temperatures can be displayed in either degrees Fahrenheit (default) or Celsius

1. On the Main timer bar, press and hold the Prince Castle Logo and Menu/Enter buttons together for 6 seconds. The display will change to program mode.
2. Use the Up and Down Arrow buttons to scroll to the DEGR F/C display.
3. Press the Menu/Enter button. Either the F or C will begin flashing to indicate the currently selected scale, F (Fahrenheit) or C (Celsius).
4. Use the Up and Down Arrow buttons to change the selected scale.
5. Press the Menu/Enter button to accept any changes. The flashing will stop.
6. Press the Prince Castle Logo button when done. The bar will return to normal operating mode.

Positioning The Timer Bars

Timer Bar Positions:

This feature allows a single time bar model to be set to a specific position on a bin. The difference between positions is the layout of the menu items assigned to the individual timer channels. The bin heater controls are only available on the bar set to position POSA, and not available when set to positions POSB or POSC.

This set-up should only be done once, typically at the factory or during bar replacement in the field.

To set the main timer bar to a different position, perform the following:

1. On the Main timer bar, press the Prince Castle Logo, Up and Down buttons at the same time, holding for 6 seconds.
2. Release the buttons after the displays on the bar show:

POSN **↑↓** **ENTR** **POSx**

x = the current bar position setting

3. Use the Up and Down Arrow buttons to select the desired position. The position choices are POSA, POSB, and POSC. The right most display shows the position letter to be selected.
4. To accept the displayed position, press the Menu/Enter button on the timer bar. To cancel without accepting, press the Prince Castle Logo button.

To check the current position, address setting and heater control enabled state on the Main timer bar without making a change, press and hold the Down Arrow button. Defaults for the timer bar position POSA as of software version 9.40 are displayed below:

	Software Version	Bar Position	Bar Address
VERS	9.40	POSA	BAR1

The timer bar address and heater control setting are automatically set when the bar position is selected as follows:

Bar Position	Bar Address	Heater Control
POSA	BAR1	ON
POSB	BAR2	OFF
POSC	BAR3	OFF

The bar address can be changed at power on as on other bars, but loading presets will change the address back to the default as listed above. Changing the bar position will also change the address back to the default as listed above. Loading presets will not change the selected position.

Selecting Breakfast and Regular Menus

1 There are six menus available:
 BKFT LED ON = Breakfast1 or Breakfast2
 REG LED ON = Regular1, Regular2, Regular3, or Regular4
 Press and hold the MENU/ENTER button, then use the UP or DOWN Arrow button to scroll through the 6 menus.

When scrolling, menu appear in this display.

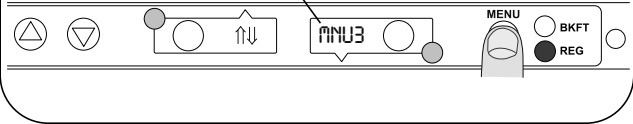

2 When the desired menu is displayed, release the MENU/ENTER button. The food products for the menu will be displayed in the PAN displays.

When you change to a new menu, any timers started before the change will flash the product name from the previous menu. Press the PAN button next to the flashing display to cancel the timer and stop the display from flashing.

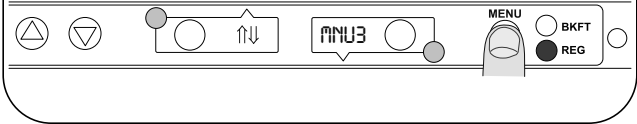

Programming the Menus

1 Press and hold the PRINCE CASTLE LOGO button (on the button bar) until all the displays show PROG and the PAN buttons LEDs all glow RED.

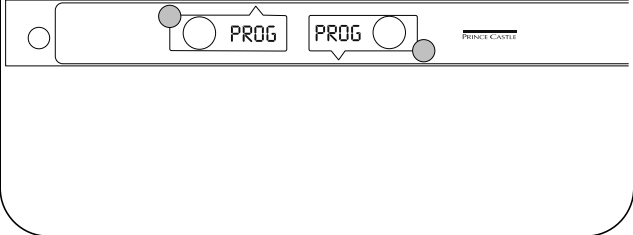

2 Press and hold the MENU/ENTER button, then use the UP or DOWN Arrow button to scroll through the 6 menus. Release the MENU/ENTER button when the desired menu is displayed.

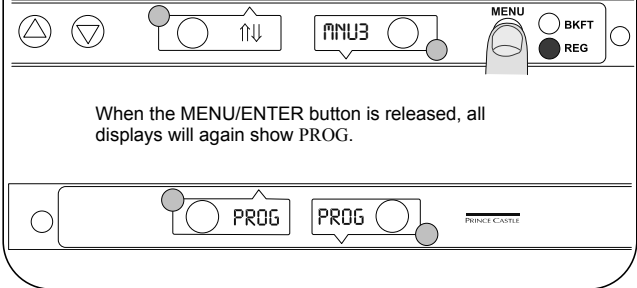

When the MENU/ENTER button is released, all displays will again show PROG.

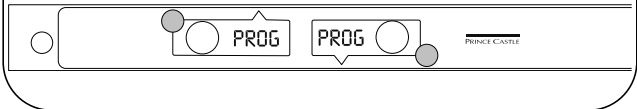

3 Press the PAN button next to the display to be changed. The LED will change from RED to YELLOW and the display will change from PROG to the assigned menu item.



Press the UP or DOWN Arrow button to scroll to the desired product. Press the MENU/ENTER button to save the selection. All other displays will show PROG.

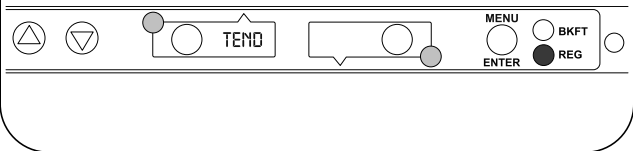

4 Repeat Steps 2 – 3 as required. Press the PRINCE CASTLE LOGO button to exit the Program Mode.
NOTE: A pan may be set as "not used" by assigning "----" as its product.

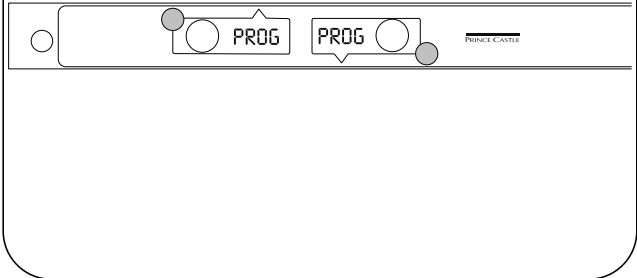

Changing the Hold and Cook-More Times

- 1 The SET PRODUCT TIME menu is used to change the Hold and Cook-More times.
Press and hold the PRINCE CASTLE LOGO button, then immediately press and hold the MENU/ENTER button until the display shows one of four programming menus.
Use the UP or DOWN Arrow button to scroll to the SET PROD TIME ↑↓ ENTR (Set Product Time) menu.

PRINCE CASTLE LOGO Button

MENU/ENTER Button

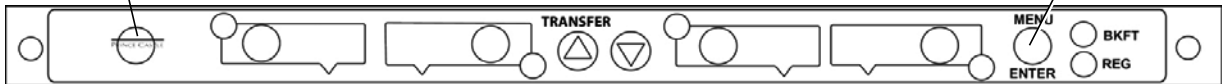

- 2 Press and release the MENU/ENTER button to enter the Set Product Time menu. The display will show, for example, SET EGGS TIME ↑↓ ENTR.
Use the UP or DOWN Arrow button to scroll through the list of products. When the desired product is displayed, press the MENU/ENTER button to select it.



NOTE: Holding the UP or DOWN Arrow button for longer than 2 seconds will cause the product list to automatically scroll up or down.

- 3 The display will show the current Hold time.



Use the UP or DOWN Arrow button to scroll to the desired Hold time. When the desired Hold time is displayed, press the MENU/ENTER button to save the desired Hold time.

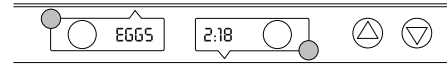

NOTE: Hold time cannot be reduced to less than the Cook-More time plus one minute.

- 4 The display will now show cook EGGS:07 ↑↓ ENTR (the Cook-More time).



Use the UP or DOWN Arrow button to scroll to the desired Cook-More time. When the new desired Cook-More time is displayed, press the MENU/ENTER button to save it.

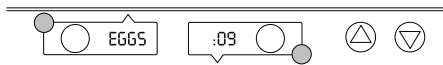

NOTE: Cook-More time cannot be increased to more than the Hold time plus one minute.

- 5 The display will show SET PROD TIME ↑↓ ENTR. Repeat Steps 2 – 4 for any other product.
Press and release the PRINCE CASTLE LOGO button at any time to exit the Program Mode and return to the Run Mode.

NOTE: If the MENU/ENTER button has not been pressed to save any changes, the program will revert to the original values.



Changing Product Names

1 The EDIT PRODUCT NAME menu is used to change a default product name to one of your own choosing.
Press and hold the PRINCE CASTLE LOGO button, then immediately press and hold the MENU/ENTER button until the display shows one of four programming menus.
Use the UP or DOWN Arrow button to scroll to the SEL PROD xxxx ↑↓ ENTR (Edit Product Name) menu.

PRINCE CASTLE LOGO Button

MENU/ENTER Button



2 Press and release the MENU/ENTER button to enter the Edit Product Name menu.
Use the UP or DOWN Arrow button to scroll through the list of products. When the desired product is displayed, press the MENU/ENTER button to select it.
The first letter (in this case, the E) will start blinking.



3 To change the blinking E, use the UP or DOWN Arrow button to scroll to the desired letter/number/symbol. When the desired selection is displayed, press the PAN button to move to the next digit. Repeat for all digits.

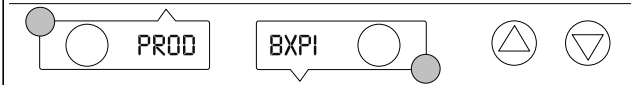

NOTE: Holding the UP or DOWN Arrow button for longer than 2 seconds will cause the display to automatically scroll up or down.

4 When all four digits have been changed, press the MENU/ENTER button to select the new name.



5 The display will show edit prod name ↑↓entr. Repeat Steps 2 – 4 for any other product.
Press and release the PRINCE CASTLE LOGO button at any time to exit the Program Mode and return to the Run Mode.
NOTE: If the MENU/ENTER button has not been pressed to save any changes, the program will revert to the original names.



Factory Presets

Product Menu Details			
Product	Display Name	Hold Minutes ¹	Cook-More Minutes ¹
Limited Time Offering	LTO3	30	0
Limited Time Offering	LT04	40	0
Spicy	SPCY	40	0
Catfish	CFSH	30	0
Popcorn Shrimp	PCRN	30	0
Fillet	FILL	40	0
Nugget	NUGG	40	0
Mild	MILD	40	0
Onion Ring	ORNG	15	0
Butterfly Shrimp	BFLY	30	0
Country Fried Steak	STAK	40	0
Custom 1	CSM1	30	0
Custom 2	CSM2	30	0
Custom 3	CSM3	30	0
Custom 4	CSM4	30	0
Custom 5	CSM5	30	0
Custom 6	CSM6	30	0
Custom 7	CSM7	30	0
Custom 8	CSM8	30	0
Custom 9	CSM9	30	0
Custom A	CSMA	30	0
Custom B	CSMB	30	0

1. Hold and Cook-More times may be re-programmed. See page 11. The Cook-More alarm will not sound because alarm set to zero (0)

Factory Presets (continued)

Menus Position A - Upper Timer Bar

Timer 4	Timer 3	Timer 2	Timer 1	Menu	Indicator
PCRN	PCRN	MILD	MILD	MNU1	Off
PCRN	PCRN	MILD	MILD	MNU2	Off
PCRN	PCRN	MILD	MILD	MNU3	Off
PCRN	PCRN	MILD	MILD	MNU4	Off
PCRN	PCRN	MILD	MILD	MNU5	Off
PCRN	PCRN	MILD	MILD	MNU6	Off

Menus Position B - Middle Timer Bar

Timer 4	Timer 3	Timer 2	Timer 1	Menu	Indicator
NUGG	NUGG	LTO4	LTO4	MNU1	Off
NUGG	NUGG	LTO4	LTO4	MNU2	Off
NUGG	NUGG	LTO4	LTO4	MNU3	Off
NUGG	NUGG	LTO4	LTO4	MNU4	Off
NUGG	NUGG	LTO4	LTO4	MNU5	Off
NUGG	NUGG	LTO4	LTO4	MNU6	Off

Menus Position B - Middle Timer Bar

Timer 4	Timer 3	Timer 2	Timer 1	Menu	Indicator
LTO3	LTO3	SPCY	SPCY	MNU1	Off
LTO3	LTO3	SPCY	SPCY	MNU2	Off
LTO3	LTO3	SPCY	SPCY	MNU3	Off
LTO3	LTO3	SPCY	SPCY	MNU4	Off
LTO3	LTO3	SPCY	SPCY	MNU5	Off
LTO3	LTO3	SPCY	SPCY	MNU6	Off

Troubleshooting

PROBLEM	PROBABLE CAUSE	SOLUTION
Display flashes OpN and REL.	Open relay. Circuit inoperable.	Replace main PCB
Display flashes SHR and REL.	Shorted relay. Circuit inoperable. Open heater. Unplugged ribbon cable between power and main circuit boards.	Replace main PCB. Test heater resistance (150.2 Ohms). Replace heater if necessary. Verify ribbon cable connection.
Display flashes OPN and REL.	Temperature is below 75°F (24°C). Heater inoperable. Probe inoperable. Relay inoperable.	Normal display during warmup. Test heater resistance (150.2 Ohms). Check for open thermocouple wires from probe. Replace heater/probe assembly. Replace main PCB.
Display shows HHH for an extended period of time and heater surface temperature is hot.	Temperature is above 300°F (149°C) (abnormal operation).	Diagnostic circuit inoperable. Replace main PCB.
Display shows HHH for an extended period of time and heater surface temperature is cool.	Probe is inoperable.	Check for pinched thermocouple wires from probe. Replace heater/probe assembly.

Wiring Diagram

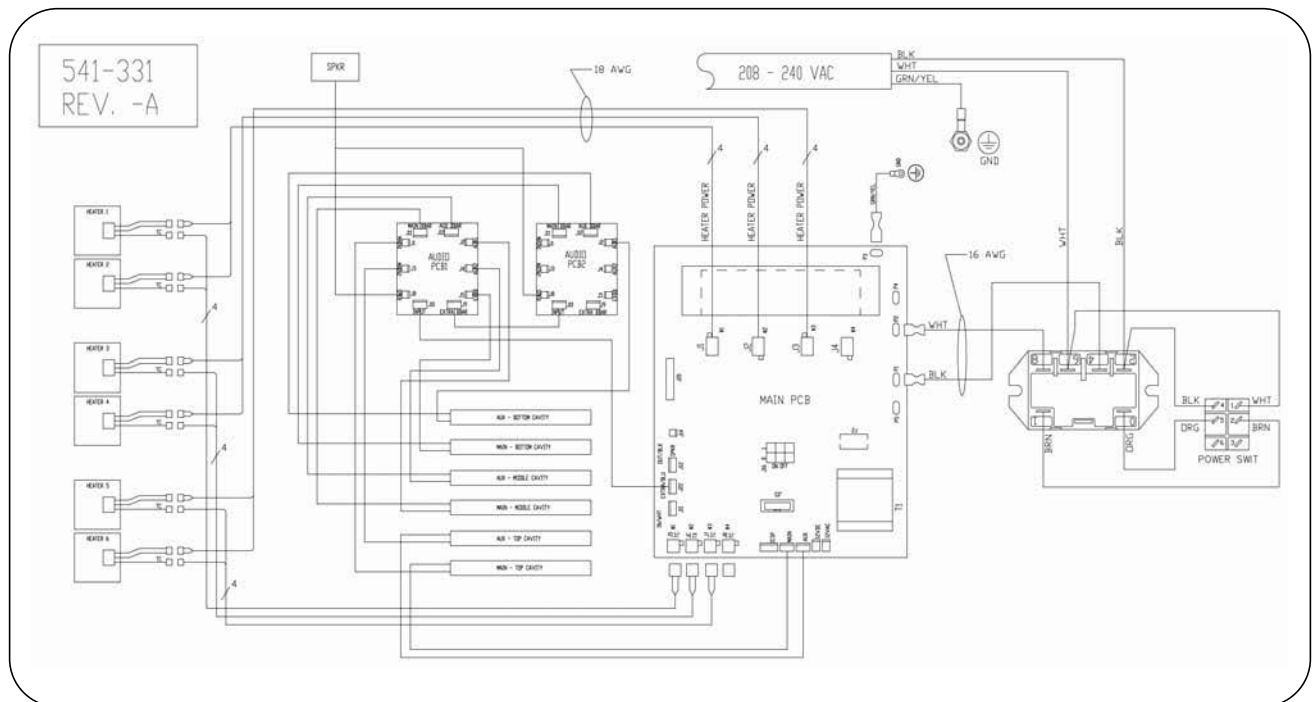

Exploded View and Parts List

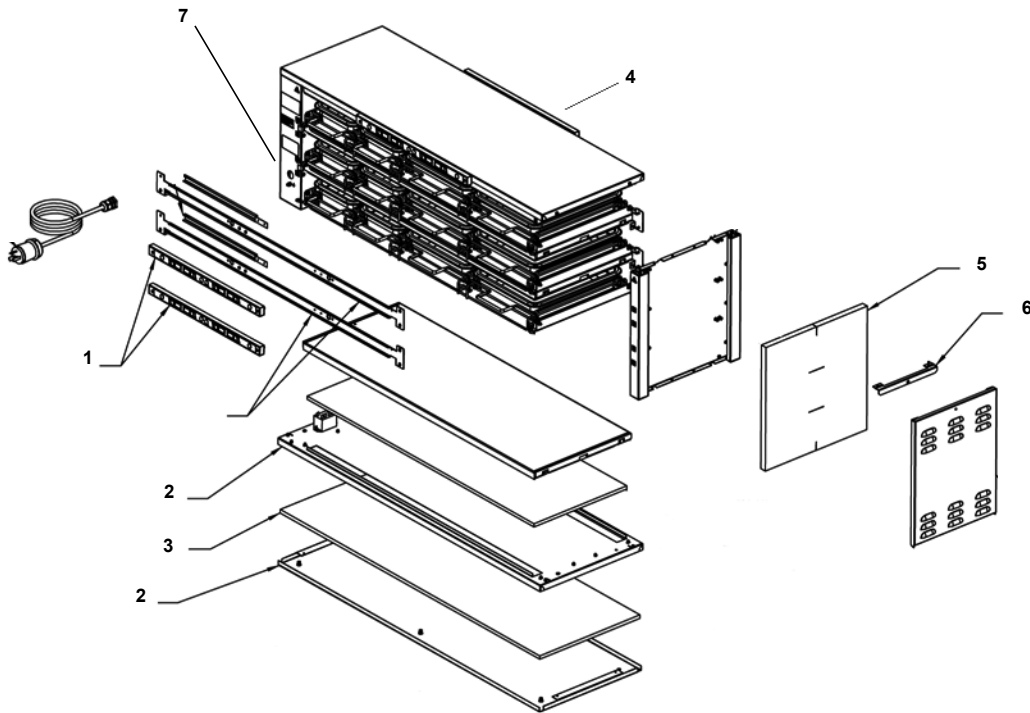

Ref.	Part No.	Description	Ref.	Part No.	Description
1	541-1181S	Main Timer Bar Kit (41A)	4	541-1182S	Aux Timer Bar Kit (41A)
	510-124S	Top Main Timer Bar Kit (30)		510-125S	Top Aux Timer Bar Kit (30)
	510-122S	Bottom Main Timer Bar Kit (30)		510-123S	Bottom Aux Timer Bar Kit (30)
2	540-834S	Lower Heater Kit (41A)	5	541-1206S	Main Brd Kit (30/41A)
	542-366S	Top Shelf Lower Heater Kit (30)	6	740-650S	PCB Audio Interface
	542-359S	Bottom Shelf Lower Heater Kit (30)	7	78-184S	Power Switch
3	540-833S	Upper Heater Kit (41A)			
	542-366S	Top Shelf Upper Heater Kit (30)			
	542-363S	Bottom Shelf Upper Heater Kit (30)			

PRINCE CASTLE LLC **WORLDWIDE**

A Marmon Group/Berkshire Hathaway Company

205 Lies Rd • Carol Stream, IL 60188 USA
 Telephone: 630-462-8800 • Fax: 630-462-1460 Toll
 Free: 1-800-PCASTLE
www.princecastle.com

PRINCE CASTLE LLC 
WORLDWIDE



A Marmon Group/Berkshire Hathaway Company

205 Lies Rd• Carol Stream, IL 60188 USA
Telephone: 630-462-8800 • Fax: 630-462-1460 Toll
Free: 1-800-PCASTLE
www.princecastle.com

Printed in USA 05/12 © 2014
Prince Castle LLC