

# Operation Manual

Toaster  
TX-208BK15



## LIMITED WARRANTY

This product is warranted to be free from defects in material and/or workmanship for a period of 1 year from date of original installation, not to exceed 18 months from the date of manufacture.

Any component which proves to be faulty in material and/or workmanship will be replaced or repaired (at the option of Prince Castle, Inc.) without cost to the customer for parts and labor. This warranty covers on-location service (i.e. trip charges and/or mileage). Travel mileage is limited to 100 miles (200 Kilometers) round trip (one trip warranty) from an authorized service agency or its sub-service agency.

This warranty is subject to the following exceptions/conditions:

- Use of any non-genuine Prince Castle parts voids this warranty.
- All labor to be performed during regular work hours. Overtime premium (the incremental amount) will be charged to the customer.
- Damage caused by carelessness, neglect and/or abuse (e.g., dropping, tampering or altering parts, equipment damaged in shipment, by fire, flood or an act of God) is not covered under this warranty.
- All problems due to operation at voltages other than that specified on equipment nameplates are not covered by this warranty. Conversion to correct voltage is the customer's responsibility.
- This equipment must be serviced by Prince Castle Authorized Service Agency or a Prince Castle Service Technician during the warranty period.

## TABLE OF CONTENTS

Safety Information	2
Electrical Specifications	2
Product Identification	2
Installation	2
Operation	3
Daily Cleaning	4
Programming	6
Troubleshooting	7
Exploded View and Parts List	8,9
Wiring Diagram	10



**PRINCE CASTLE LLC**  
WORLDWIDE



355 East Kehoe Blvd. • Carol Stream, IL 60188 USA  
Telephone: 630-462-8800 • Toll Free: 1-800-PCASTLE  
Fax: 630-462-1460 • www.princecastle.com

**Safety Information**

**⚠ WARNING**

Indicates information important to the proper operation of the unit. Failure to observe may result in damage to the equipment and/or severe bodily injury or death.

**⚠ CAUTION**

Indicates information important to the operation of the unit. Failure to observe may result in damage to the equipment.

**Electrical Specifications**

Model No.	Volts	Watts	Amps	Hz
TX-208BK	208	4000	19.2	60

**Product Identification**

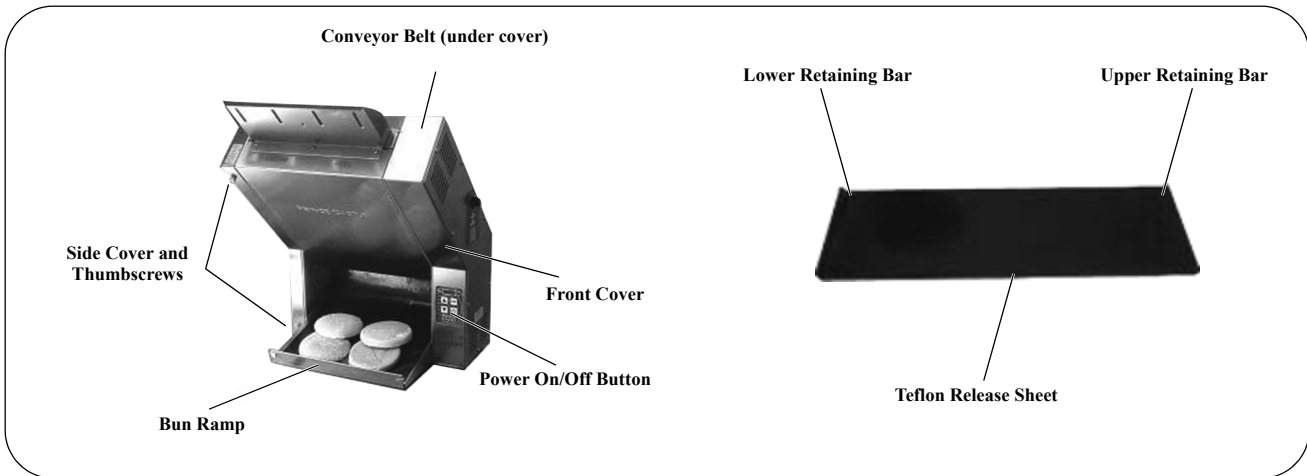

**Installation**

Remove the unit from the carton and inspect for signs of damage. If there is damage to the unit:

- notify the carrier within 24 hours of delivery
- save carton and packaging materials for inspection purposes
- contact your local dealer, or if purchased directly, the Prince Castle Sales Department at 800-722-7853 or 1-630-462-8800 to arrange for a replacement unit.

Verify that all parts have been received. Plug the power cord into the proper electrical receptacle. All electrical connections must be in accordance with local electrical codes and any other applicable codes.

**Important**

Prince Castle reserves the right to change specifications and product design without notice. Such revisions do not entitle the buyer to corresponding changes, improvements, additions or replacements for previously purchased equipment.

## Operation

- 1** Press the On/Off button to turn the unit on.

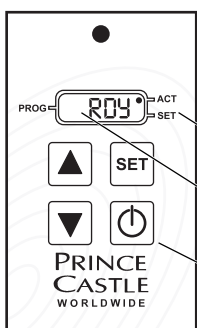

The conveyor will begin to turn and the display will read "LO".  
When the unit is at operating temperature the display will read "RDY" and the ACT (actual temperature) LED will be lit.

Temperature LEDs  
Display  
Power On/Off Button

- 3** Feed the buns into the bun chute, flat (toasted) side up.



Bun Chute

- 2** Turn the Bun Thickness Adjustment Knobs to the desired settings.

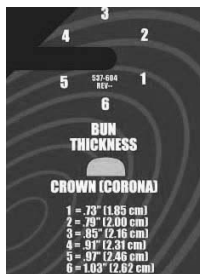

Left Side Control  
1 = Thinnest Cut  
6 = Thickest Cut

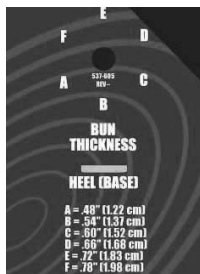

Right Side Control  
A = Thinnest Cut  
F = Thickest Cut

- 4** Press the On/Off button to turn the unit off.

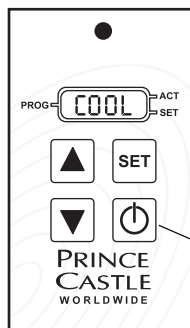

If the heater is above 450°F, the display will alternately show "COOL" and "OFF", and the conveyor belt will continue to run approximately 45 minutes. When the unit has cooled sufficiently, the display will go blank and the conveyor motor will turn off.

Power On/Off Button

NOTE: Factory preset temperature is 570°F and should provide satisfactory results in most applications. Maximum temperature of unit is 580°F (304°C).

## Daily Cleaning

### WARNING

Before performing any maintenance, press the power switch to the OFF position. If the heater is above 450°F, the display will alternately show “COOL” and “OFF”, and the conveyor belt will continue to run approximately 45 minutes. When the unit has cooled sufficiently, the display will go blank and the conveyor motor will turn off.

Unplug the power cord from the electrical receptacle.

## Important

The conveyor belt and Teflon release sheet should be cleaned twice weekly while they are still hot. Use Sizzle Plus from Kay Chemical (800-529-5458) or other degreaser and a No-Scratch pad. The Teflon sheet has four rotation uses: both sides and turned end-to-end.

## Cleaning Notes

1. The residue is typically in the center 3" region of both the left-hand and right-hand halves of the belt.
2. For best results clean the belt twice weekly, cleaning on Monday and Friday.
3. Wash and sanitize hands.

## Why Clean

As buns are toasted, a residue is left on the belt. When the residue dries it becomes slick and the belt may start to slide under the bun without pulling the bun through the toaster. Replacing the Teflon release sheet will help extend belt life but the best action is to clean the belt, retaining its ability to grip the bun. Once buns begin slipping on the belt it is too late to clean the belt. The buildup is easy to remove while it is still fresh. It takes about five minutes to clean and should be cleaned twice weekly (there is only one belt on the TX Toaster). If cleaned twice weekly, you can expect the belt to last about 3-4 months. If the belt is not cleaned twice weekly, then you will need to replace it every 3-4 weeks.

- 1 Press the On/Off button to turn the unit on.

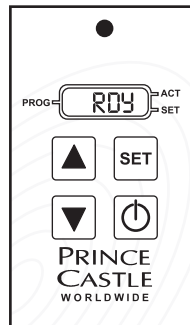

This will allow the toaster to come up to temperature.

The display will show “rdy.”

*NOTE: If the unit is already on, then you can skip this step.*

## Recommended Protective Equipment

1. Heat-resistant glove
2. Protective goggles or face shield

## Safety Information

### CAUTION – TOASTER MAY BE HOT

This unit is not watertight. Do not clean with a water jet/jet spray. Do not immerse the unit in water.

1. Remember that there is a hot platen inside the toaster, and the belt will continue to run during cleaning.
2. Cover adjacent food holding containers to prevent cleaner from dripping onto food or food holding equipment.
3. Some steam and smoke will be produced as a result of cleaning. Ensure that the ventilation system is ON during belt cleaning.

- 2 Remove the black Teflon release sheet and place it on a clean surface. Next, remove the front cover and also place it on a clean surface.

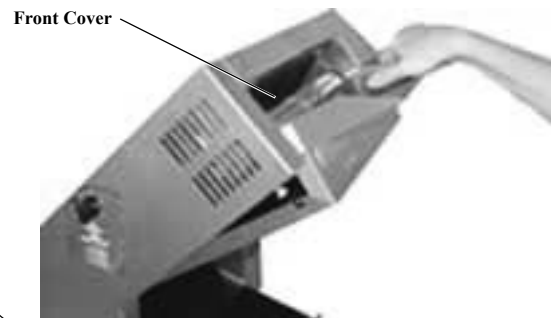

**Daily Cleaning (continued)**

**3** Apply 1/2 oz. cleaner (Sizzle Plus) to the No-Scratch pad and coat the right-hand half of the belt as it turns so the full belt length is wetted. Rub pad on belt for two full belt rotations.  
Apply 1/2 oz. cleaner to pad and repeat on left-hand of the belt.

While applying cleaner, press the pad to the belt to squeeze cleaner from the sponge onto the belt.  
Apply cleaner liberally to insure the whole belt surface is coated. Ensure that there are no dry spots on the belt.  
The belt surface should be wet, more than damp, but try to avoid dripping cleaner onto the toaster base.



In the four steps below it is most important to clean the 3" center sections in the left- and right-hand portions of the belt. Use gentle pressure when wiping the belt. Since cleaning is ultimately dependent on time and temperature, you do not need to apply heavy pressure to the cleaning pad.

**4** Use the no-scratch cleaning pad with gentle pressure to scrub the left-hand of the belt in a left-to-right motion for two belt rotations.  
Continue scrubbing in an up-down motion for an additional two rotations.

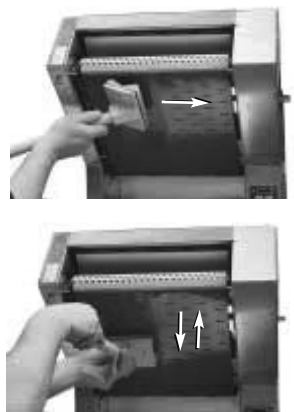

**5** Repeat on the right-hand half of the belt.

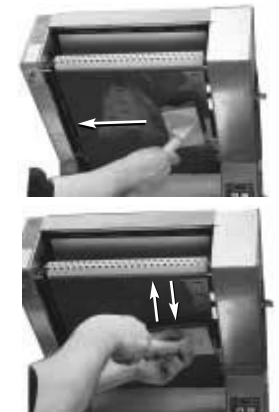

**6** Fill a plastic pan half full of warm water and position it near the toaster. Wearing a heat-resistant glove, use a wet cloth from the sanitizer bucket to wipe residue from the belt. Rinse the cloth in the pan of water. Continue wiping and rinsing until no more residue is wiped from the belt.

Use a clean damp cloth from the sanitizer bucket to thoroughly wipe the belt for two revolutions.



**7** Use another clean damp cloth from the sanitizer bucket to wipe the black Teflon release sheet. Replace the black Teflon sheet.  
Wipe the exterior of the toaster and adjacent surfaces with a clean cloth from the sanitizer bucket.

**IMPORTANT!** To get maximum use of the Teflon release sheet, use both sides of the contact surface. When reinstalling sheet, rotate the usage by turning sheet top-to-bottom and/or inside out. With proper cleaning and rotation, a Teflon release sheet should last up to 4 months.

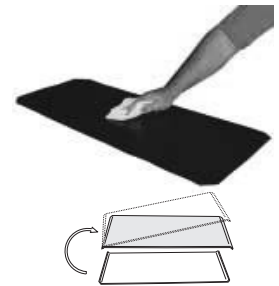

**8** Replace the Teflon sheet and front cover. The toaster belt is now clean and ready to use.

**Programming**

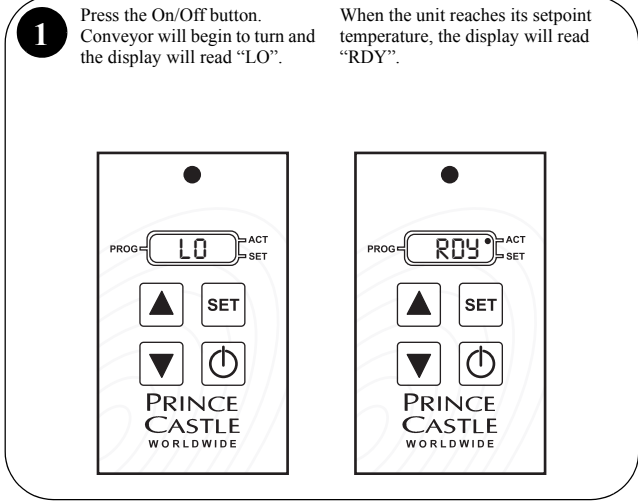
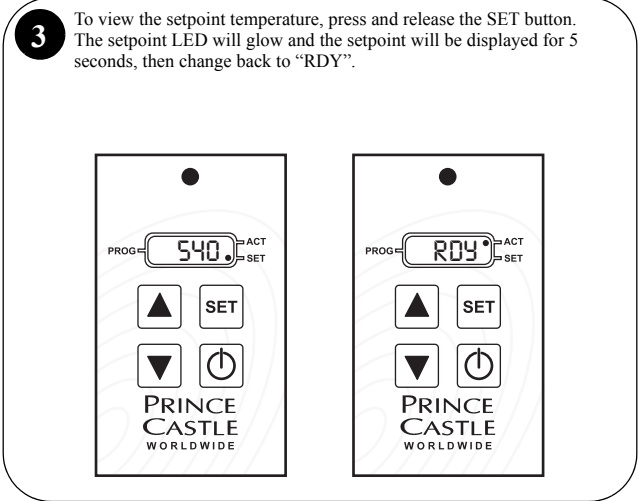
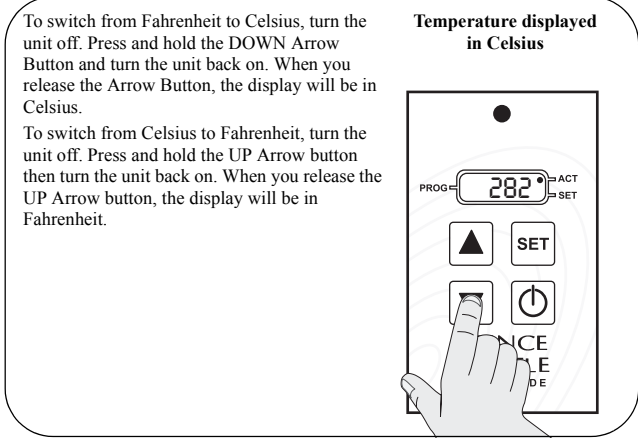
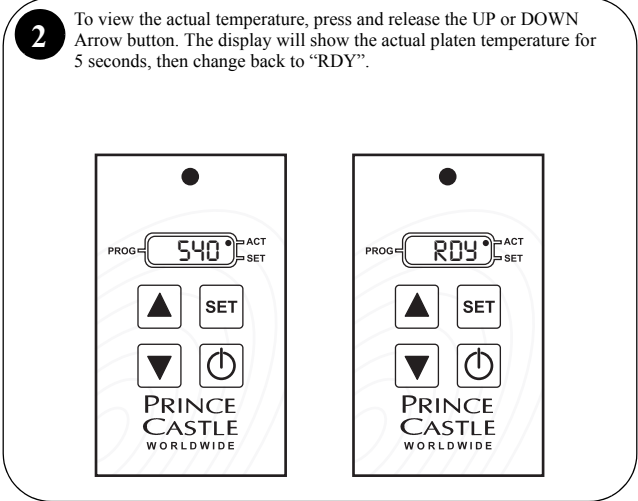
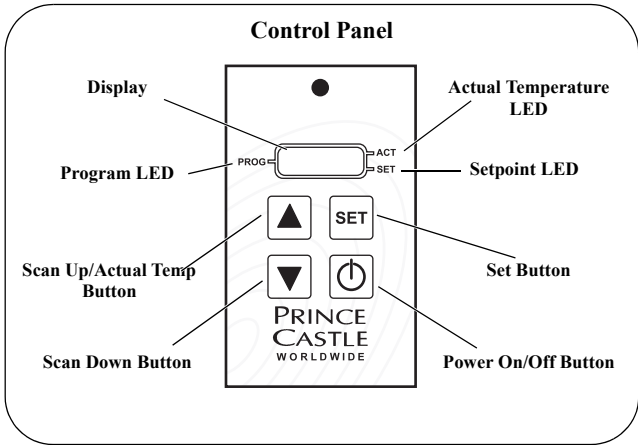

### Programming (continued)

- 4** To change the setpoint temperature, press and hold the SET button for 6 seconds. The setpoint and program LEDs will glow and the setpoint will be displayed.

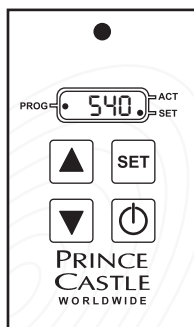

- 5** Use the UP or DOWN Arrow button to adjust to the desired setpoint. Press and release the SET button to save the new setpoint and return to the operation mode.

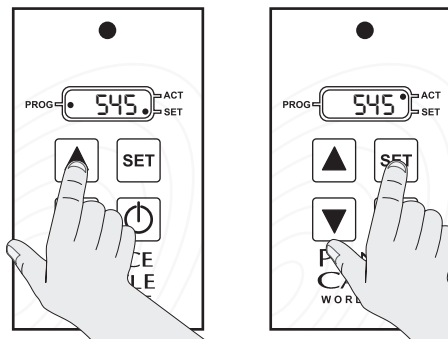

### Troubleshooting

PROBLEM	PROBABLE CAUSE	SOLUTION
Unit will not heat up.	No power to unit.  Inoperable power cord. Loose connection on power switch. Inoperable power switch. High limit switch tripped.	Make sure power cord is plugged into the unit and proper electrical receptacle. Replace power cord. Tighten power switch connections. Replace power switch. Reset limit switch. Using a pencil or pen, press the hollow portion of the 3/8" long brown, plastic stem located at the right-hand rear of the unit. Allow the unit to cool (approximately 15 minutes) before starting.
Unit heats up but conveyor will not run.	Loose motor connection. Inoperable motor. Stripped drive gear. High limit switch tripped.	Tighten motor connection. Replace motor. Replace drive gear. Reset limit switch. Allow the unit to cool (approximately 15 minutes) before starting.
Buns under or over done.	Check bun crush setting. Verify setpoint temperature. Dirty teflon sheet.	Adjust for proper compression. Adjust setpoint for proper temperature. Clean or replace teflon sheet.

When the platen temperature drops 24° or more below the setpoint temperature, the display will switch from "RDY" to "LO". If the display remains at "LO" for 30 minutes, contact an authorized Prince Castle Service Agent.

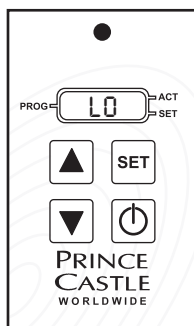

To extend the life of the motor, add 2 – 3 drops of high-temperature oil on a monthly basis. This task can be performed by an authorized technician.

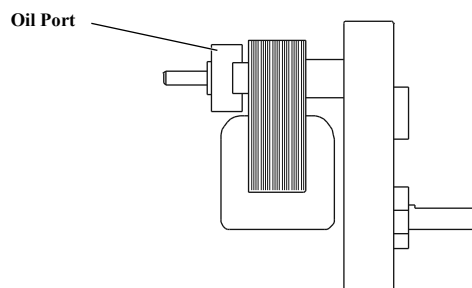

The drive chain must be lubricated every 6 months. Apply a few drops of 30 weight oil.

**Exploded View and Parts List**

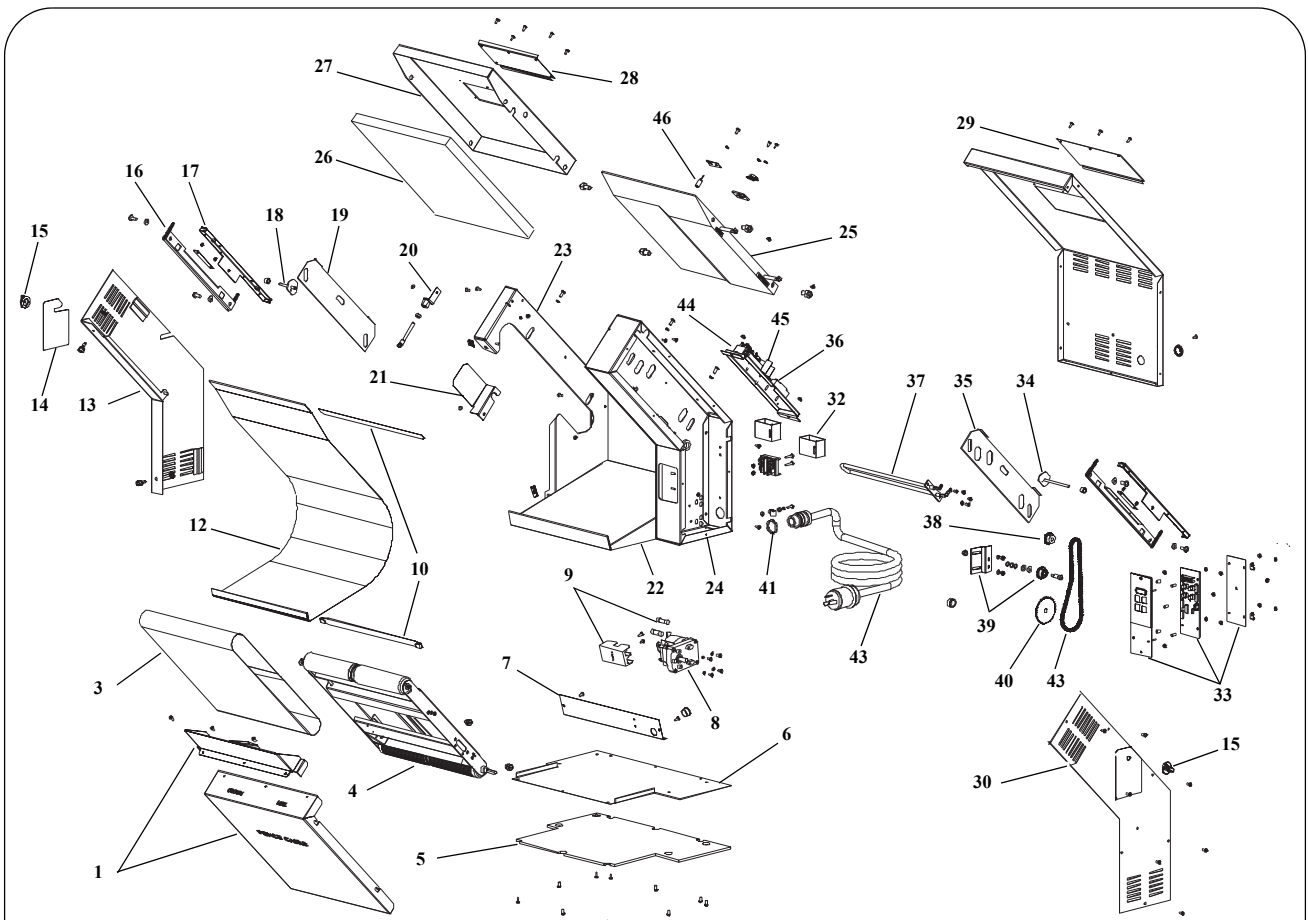

Ref.	Part No.	Description	Ref.	Part No.	Description
1	537-711S	Front Cover	27	537-296	Heater Housing
3	537-725S	Rubber Belt	28	537-366	Heater Housing Plate
4	537-330S	Conveyor Assy	29	537-321	Rear Panel
5	537-338	Base Pad	30	537-332	RH Cover
6	537-320	Bottom Plate	32	537-665	Hi-Temperature Switch
7	537-373	Ramp Baffle	33	537-663S	PC Board and Overlay Assy.
8	87-028TXCS	Motor	34	537-328	RH Cam Shaft
9	88-577S	Fuse Block	35	537-229	RH Slide Plate
	88-578S	Fuse (Pkg. of 2)	36	65-058S	Heater Relay
10	573-378S	Retainer Bar Kit	37	537-341S	Heater
12	537-403-3S	Teflon Sheet	38	86-355S	Sprocket
13	537-333	LH Cover	39	537-735S	Idler Sprocket and Bracket Assy.
14	537-385	Bun Crush Overlay	40	537-340	Sprocket
15	70-050	Bun Crush Adj. Knob	41	66-034	Strain Relief
16	537-298	Cam Bracket	42	72-190S	Power Cord
17	537-379	Guide Bracket	43	537-728S	Drive Chain
18	537-329	LH Cam Shaft	44	65-048S	Power Relay
19	537-300	LH Slide Plate	45	537-388S	Transformer Assy.
20	537-381	Conveyor Bracket	46	537-400S	Temperature Probe
21	537-382	Conveyor Bracket	*	428-143	Spring Clip Link
22	537-319	Ramp	*	87-028AS	Motor Only
23	537-336	LH Upright	*	537-729S	Chain and Sprocket
24	537-335	RH Upright	*	537-605S	Bun Thickness Overlay (Heel)
25	537-295S	Platen	*	537-604S	Bun Thickness Overlay (Crown)
26	537-337	Insulation			* Part not shown.



Parts List and Exploded View

Conveyor Assembly

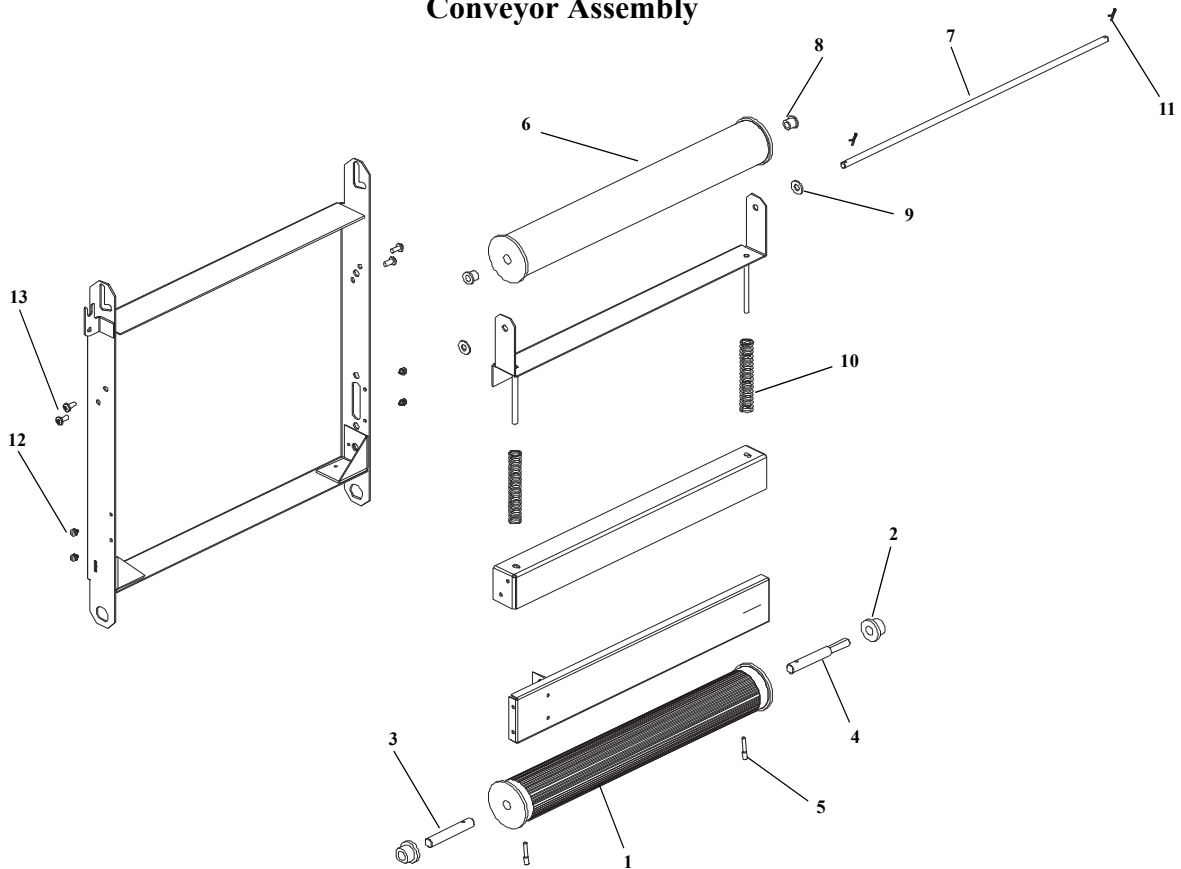

Ref.	No.	Description	Ref.	No.	Description
1	537-412	Lower Roller	8	537-317S	Upper Bearing (Pkg. of 2)
2	537-370S	Lower Bearing (Pkg. of 2)	9	79-055S	Washer (Pkg. of 4)
3	537-318S	Lower Shaft (Short)	10	81-017S	Spring (Pkg. of 2)
4	537-316S	Lower Shaft (Long)	11	86-272S	Cotter Pin (Pkg. of 2)
5	197-279S	Pin (Pkg. of 5)	12	69-011S	Rivet (Pkg. of 4)
6	537-411	Upper Roller	13		Screw / PPHMS, 8-32 x 3/8
7	537-315	Upper Shaft			

For complete Conveyor Assembly, order Part No. 537-330S

**Wiring Diagram**

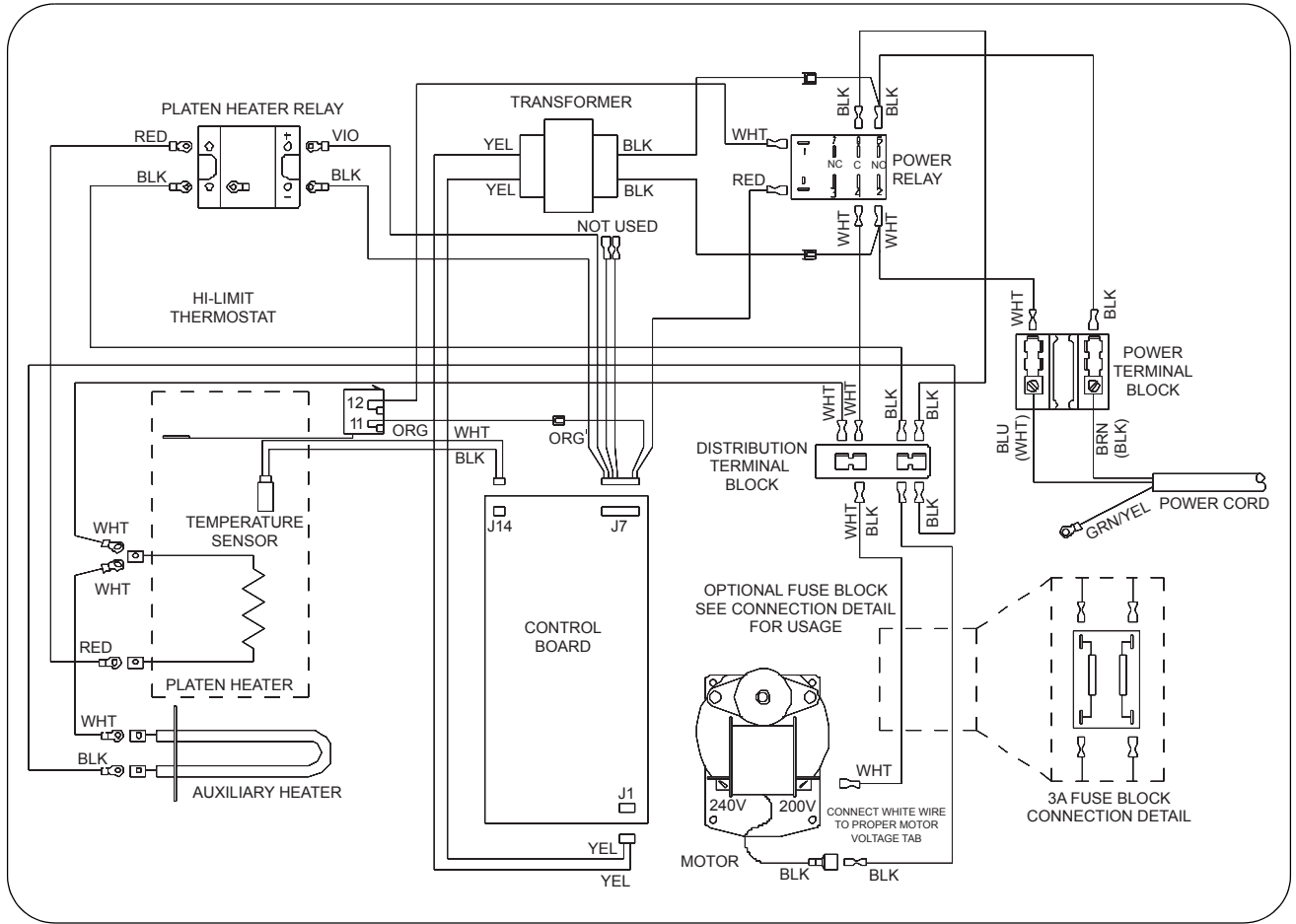

## TX-Series Toaster Bearing Noise

If customer reports that their TX toaster is making a loud “beeping” or “squeaking” sound, this is probably due to a lack of lubrication in the upper bearings. Prince Castle recommends that these bearings be lubricated with a light duty, sanitary lubricant spray. The recommended Haynes spray is commonly used and commercially available. You may already stock this item. If not, order:

**Haynes Sanitary Lubricant Spray part number: 89-1000S**

This procedure is covered under the product warranty.

### To apply lubricant:

1. Turn toaster off.
2. Remove Teflon release sheet from toaster.
3. Direct spray toward the inside surface of the left and right upper bearings.



Left-side Upper Bearing



Right-side Upper Bearing

4. Carefully wipe away any excess spray from the belt.
  5. Install Teflon sheet.
  6. Turn toaster on and test operation.
  7. If noise reoccurs, repeat application.
- For questions, please contact the Prince Castle Technical Service Department.