

Salvajor Model 500 5 HP - 3 Phase

Series H Disposer Parts Breakdown *For Serial Numbers starting at 8472*

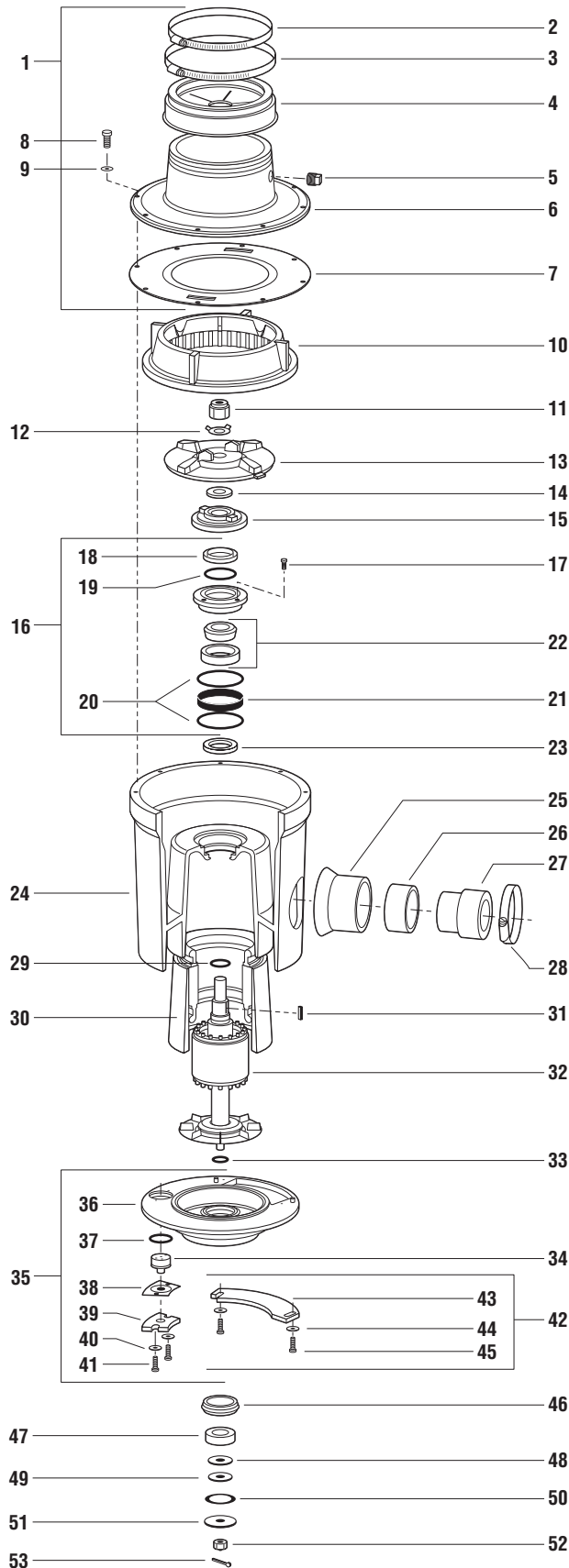

NO.	PART NO.	DESCRIPTION
1	980131	TOP HOUSING ASSY (includes 2 thru 7)
2	M116	CLAMP
3	M128	CLAMP
4	2357A	HYCAR ADAPTOR
5	PL5	PLUG 1/2" PLASTIC
6	983010	TOP HOUSING
7	996045	CENTER GASKET (S)(C)
8	997022	SCREW 5/16-18 X 1" HHCAP
9	997123	WASHER FLAT 11/32 x 5/8OD SS
10	10S	SHREDDER (C)
11	7814RN	ROTOR NUT (S)(C)
12	997092	LOCK WASHER (S)(C)
13	983006	FACE PLATE (C)
14	996025	ROTOR SHAFT GASKET (S)(C)
15	980132	ROTOR BASE (S)(C)
16	980007	TOP END BELL ASSY (S) (includes 17 thru 21)
17	997066	SCREW 10-32 X 5/8" (S)
18	S67350B	VARILIP SEAL (S)
19	995009	SPACER SEAL TEB (S)
20	12151	O-RING (S)
21	ANL79X15S	TOLERANCE RING (S)
22	985001	BEARING CUP/CONE TOP (S)
23	S67350	VARILIP SEAL (S)
24	MH3	MOTOR HOUSING 3"
25	996037	DRAIN OUTLET 3"
26	988015	DRAIN INSERT 3"
27	996038	DRAIN ADAPTOR 2"-3"
28	997131	CLAMP DISPOSER 3"
29	11026	O-RING (S)
30	5MHI	STATOR W/MOTOR HOUSING INSERT
31	997070	KEY 3/16 x 3/16 x 1" (S)
32	5318	MOTOR ROTOR 500-3
33	996020	O-RING (S)
34	KL5003	KLIXON
35	BEBA123G	BOTTOM END BELL ASSY (includes 36 thru 42)
36	983016	BOTTOM END BELL
37	123	KLIXON O-RING (S)
38	KLCG	KLIXON COVER GASKET
39	KLC	KLIXON COVER
40	997043	WASHER 10-32
41	997067	SCREW 10-32 X 3/4"
42	JBCA	JUNCTION BOX COVER ASSY (includes 43,44,45)
43	JBC	JUNCTION BOX COVER
44	997024	WASHER 3/4" OD 3/16" ID
45	997067	SCREW 10-32 X 3/4"
46	996023	BEB RUBBER ISOLATOR (S)
47	6205	BOTTOM BEARING (S)
48	987002	DRIVE WASHER (S)
49	996024	FRICTION WASHER (S)
50	987003	WAVE WASHER (S)
51	987001	RETAINING WASHER (S)
52	997050	CASTLE NUT (S)
53	997051	COTTER PIN (S)

SEAL AND CUTTING KITS

KSH123	Seal Kit (All Models)
KCGRF5	Cutting Kit (Model 500)

(S) Designates Parts included in Seal Kit (C) Designates Parts included in Cutting Kit



The Salvajor Company

4530 East 75th Terrace
Kansas City, MO 64132-2081 USA

CALL FREE: 1-888-SALVAJOR FAX FREE: 1-800-832-9373

SPECIFY VOLTAGE AND PHASE WHEN ORDERING

Printed in USA
Form No. PBK/H-500-3-09