

Introduction

This product manual contains the information needed for the setup, installation, initial start up, sanitation and maintenance of this ice machine. Keep it for future reference.

Be certain that the information applies to the model in question. If no model is listed, the information applies to all models.

This manual is organized in the same way as the expected use of the machine, it begins with specifications, goes thru unpacking and setup, shows where everything is; continues with initial start up, then describes how it works. After that is the sanitation section, followed by service diagnosis and repair.

Table of Contents

Specifications	Page 2	Technicians Only: Harvest Cycle Sequence & Other Notes	Page 22
Condenser and Ice Machine Layouts . . .	Page 3	Sanitation and Cleaning	Page 23
Pre-Installation	Page 4	Additional Maintenance	Page 24
Location & Assembly	Page 5	Additional Maintenance: Inlet Water Valve Screen	Page 25
Bin Control: Optional Installation	Page 6	Additional Maintenance: Ice Sensors, Condenser	Page 26
For The Installer: Remote Condenser . . .	Page 7	Service Diagnosis: Diagnostic Light Analysis	Page 27
Remote Condenser Location	Page 8	Service Diagnosis	Page 28
Coupling Instructions	Page 9	Service Diagnosis: Components	Page 29
Fan Relay Kit	Page 10	Service Diagnosis	Page 30
Electrical	Page 11	Operational Characteristics: CME456R	Page 31
Plumbing	Page 12	Removal and Replacement	Page 32
After Utility Connections	Page 13	Removal and Replacement: AutoIQ Controller	Page 33
Component Location and Function	Page 14	Removal and Replacement: Water Level Sensor	Page 34
AutoIQ Controller	Page 15	Refrigerant	Page 35
Initial Start Up	Page 16	Before Calling for Service	Page 36
Adjustments	Page 17		
How To Operate The AutoIQ Controller . .	Page 18		
How The Electronic Cuber Works	Page 19		
How The Electronic Cuber Works	Page 20		
Technicians Only: Freeze Cycle Sequence	Page 21		

Parts Lists and Wiring Diagrams are in the section at the center of this manual.

CME456R

Specifications

This ice machine is designed to be installed indoors, in a controlled environment. It can operate satisfactorily under a wide variety of conditions. However, Do NOT operate the machine in temperatures it has not been designed for. Do NOT operate the machine above or below the voltage limits for the particular model. Do NOT operate the machine with too little or too much water pressure.

Ice Machine Operational Limits

	Minimum	Maximum
Air Temperature	50°F.	100°F.
Water Temperature	40°F.	100°F.
Water Pressure	20 psi	80 psi
Voltage (60 Hz)	104	126

Remote Condenser Operational Limits

	Minimum	Maximum
Air Temperature	-20°F.	120°F.
Voltage (60 Hz)	104	126

Scotsman reserves the right to make design changes and/or improvements at any time. Specifications and designs are subject to change without notice.

Scotsman assumes no liability or responsibility of any kind for products manufactured by Scotsman that have been altered in any way, including the use of any parts and/or other components not specifically approved by Scotsman.

Bins:

Designed to fit a standard, 22" wide or wider open top Scotsman Ice Storage Bin. Some examples are:

- BH360: Direct Fit
- HTB555 - use KBT27
- Bins with short or no baffles require the addition of thermostat kit KSTAT-22 to lower the ice level

Dispensers

- ID150: Add adapter kit KBT42
- HD22: Direct fit

Condensers

- Single Circuit, 60 Hz: ERC111-1
- Dual Circuit, 60 Hz: ERC211-1

Also, a **Fan Relay Kit** is needed when connecting two ice machines to one condenser:

- **KCMR120 relay kit** used with 115 volt 60 Hz units

In addition, there may be other bins and dispensers that can be used, check Scotsman's sales literature for application information.

Precharged Tubing:

- 25' RTE25
- 40' RTE40
- 75' RTE75

BASIC INFORMATION

Model Number	Dimensions W x D x H (w/o bin)	Basic Electrical (volts/Hz/phase)	Use Condenser	Refrigerant Charge R-404A	Minimum Circuit Ampacity	Maximum Fuse Size
CME456RS-1C	22" x 24" x 28"	115/60/1	ERC111-1A (1 ice machine) or ERC211-1A (2 ice machines)	192 oz	20	20

Use precharged tubing kits, **RTE25** (25') or **RTE40** (40') or **RTE75** (75'). Select the length closest to the needs of the particular installation.

Condenser and Ice Machine Layouts

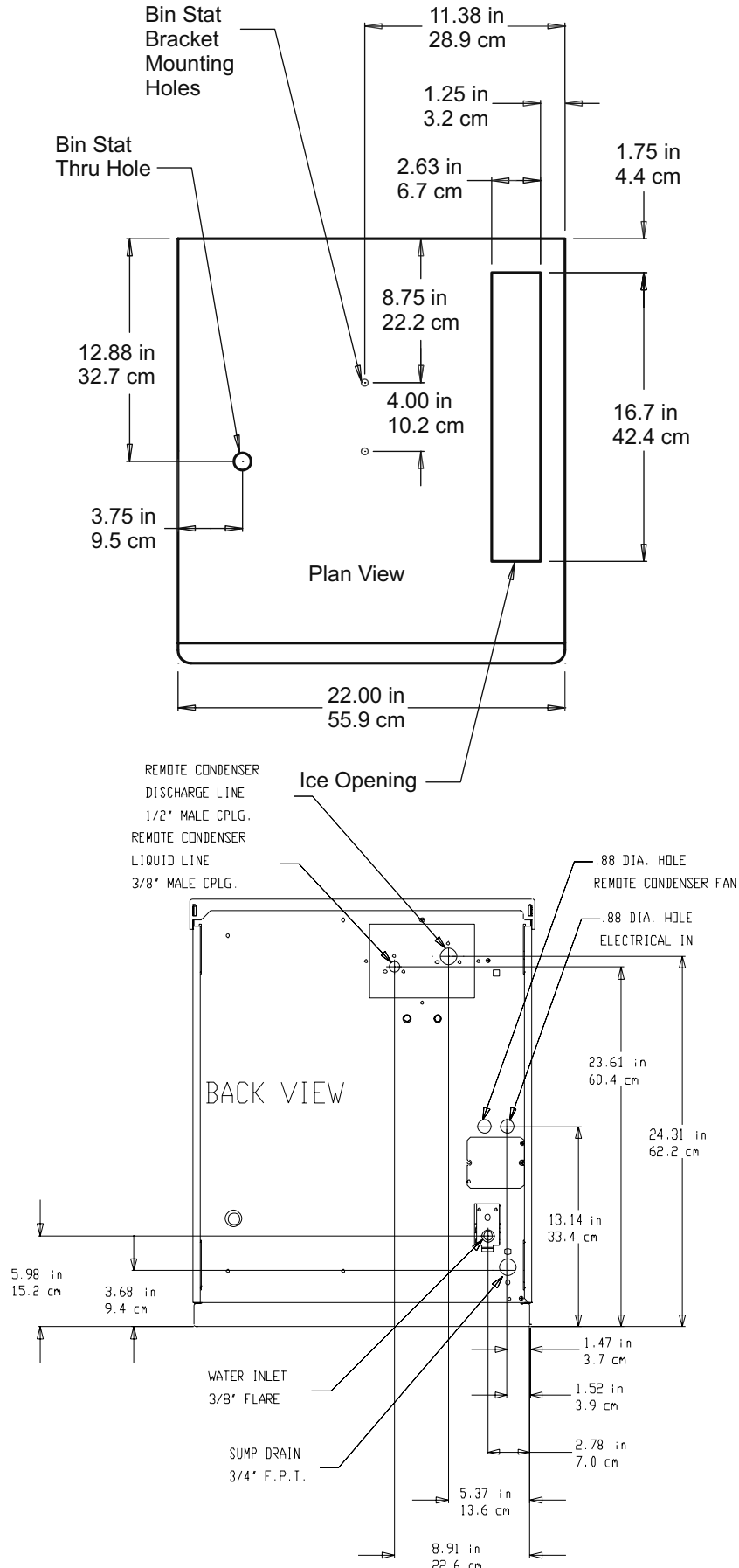

CME456R

Pre-Installation

Other Applications:

Check sales literature for additional information.

Note: Slope-front bins must have an internal baffle. Scotsman BH375 has the required baffle, and the BH260 does not need one. Baffle must be approximately in the position shown in the diagram below.

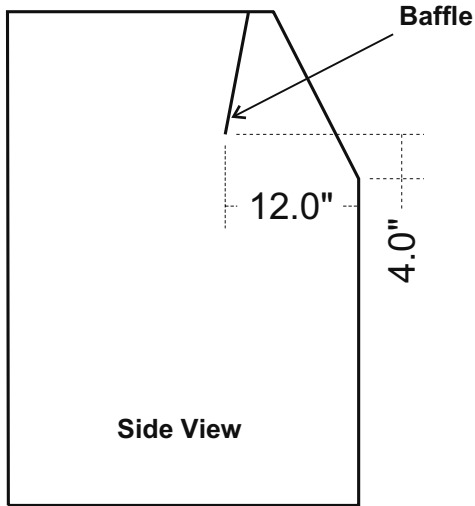

Water:

There is no such thing as pure water. All water contains some impurities. There are two ways water carries the impurities: suspended and dissolved. Suspended solids can be filtered out. Dissolved solids must be diluted or treated. Water filters are recommended to remove suspended solids. Some filters also have treatment in them for dissolved solids. Check with a water treatment service for a recommendation.

Cube Ice machines use more water than what ends up in the bin as ice. While most water is used during ice making, a portion is designed to "rinse" out the water system to keep hard water scale from clogging up the machine. That water rinse, combined with water filters, prolongs the times between needed water system cleaning.

Service Technicians: All models covered here come set from the factory with at a "Standard" water rinse. Standard water rinse is designed to be compatible with typical water conditions. The machine may be adjusted to a different water rinse after start up. If the prior ice machine worked acceptably well with the local water conditions, leave the machine at the factory setting. If severe water conditions are present, and water filters do not solve the problem acceptably, adjust the machine to use more water. If water conditions are excellent, adjust the machine to use less water. See the Adjustments section.

Electrical:

Check the nameplate for electrical requirements. The nameplate is located on the back of the ice machine. If the information on the nameplate is different from other published information, go by the nameplate data.

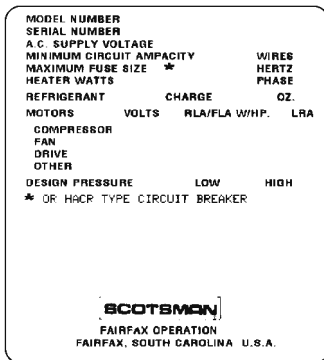

While the model and serial number are on the nameplate, a **serial number plate is located at the front of the machine, behind the front panel and to the right of the purge valve.**

Note: Water use adjustments are customer convenience adjustments; they are NOT factory defects and are NOT covered by warranty.

Nameplate, on back panel

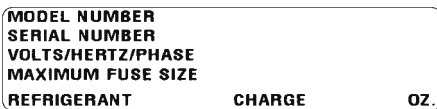

Serial Number Plate, remove front panel to locate.

Location & Assembly

Locate the ice machine indoors. A 6 inch minimum clearance on the back and sides is required for the proper operation and service of this machine.

Locate the remote condenser as close as possible to the ice machine. See page 11 for details.

Unpacking and Assembly:

Begin with unpacking the ice storage bin. Remove the carton, and using part of the carton as a cushion, tip the bin on its back to remove the skid and attach the legs or casters.

.....
Note: This unit may not be stacked.
.....

Return the bin to an upright position. Check the bin top gasket for gaps and tears, fill any in with food grade sealant prior to placing the ice machine on the bin.

.....
Note: If recycling a prior bin, be sure that the bin top gasket is in good condition or seal the ice machine to the bin with food grade sealant.
.....

Level the top edge of the bin front to back and left to right.

If the ice machine has not been unpacked, do so now. Remove the carton from the skid. Remove shipping straps.

Remove the front panel and all packaging materials.

After all packing materials have been removed from the ice machine, lift or hoist the machine onto the bin. Align the sides and back of the machine with the sides and back of the bin.

Secure the ice machine to the bin with the two metal straps and 4 bolts provided.

Cabinet Panel Removal:

1. Remove the front panel by removing the two screws connecting the top of the front panel to the machine, then pull out at the bottom.

2. Lift up at the front edge and push the top panel back until it releases from the tabs connecting it to the back panel.

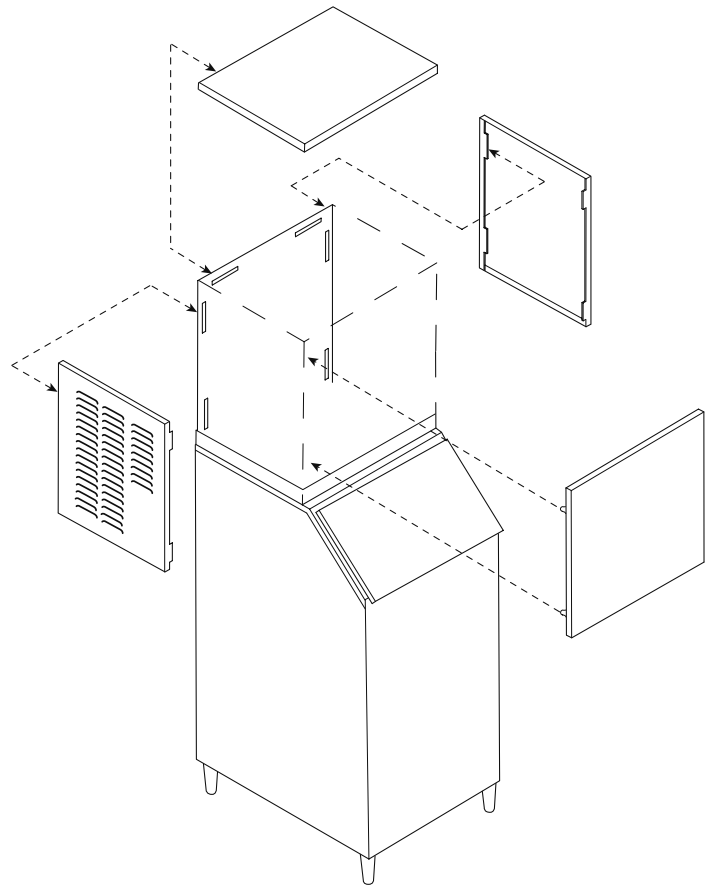

3. Remove two screws at the front of each side panel, and pull them forward until they release from the tabs connecting them to the back panel.

CME456R

Bin Control: Optional Installation

The normal bin control is the ice sensor system. A bin thermostat may be required in some cases, It **must** be field installed **after** the ice machine has been placed on the bin.

Before starting, remove the front panel and any baffle in the bin.

1. Place thermostat in machine behind the high voltage box. Secure to existing holes with two screws. Locate bin thermostat bulb.

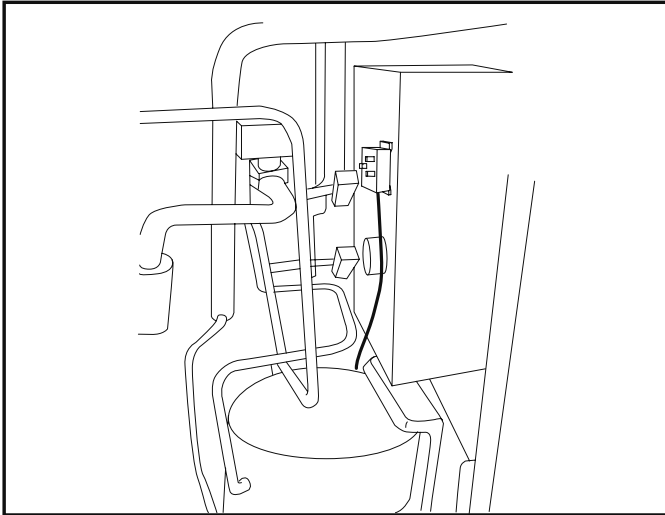

2. Route bulb thru routing tube (located between the compressor and the reservoir).

3. Connect harness to bin thermostat and to controller.

4. Locate bin thermostat bracket.

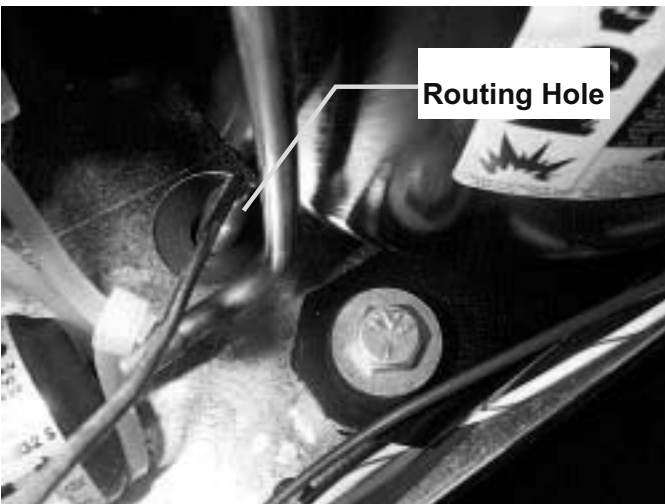

5. Carefully position the thermostat bulb on the bracket.

6. Fasten the bracket to the bottom of the ice machine with the two 3-pronged knobs supplied with the unit.



7. Pull excess capillary tubing into the machine.



8. Return the baffle to the bin and continue with the installation.

Note: If the machine is located at an altitude higher than 2,000 ft., adjust the thermostat by removing the plastic cover and rotating the adjustment screw per the table.

Bin Thermostat Altitude Correction Table			
CW Turns of Range Screw (under plastic cover)			
Feet	Turns	Feet	Turns
2000	55°	8000	340°
4000	160°	9000	385°

Use This Table to Adjust Thermostat

For The Installer: Remote Condenser

Locate the condenser as **near as possible** to the interior location of the ice maker.

 Note: The location of the condenser relative to the ice machine is LIMITED by the specification on the following page.

Select the best available location, one that protects the condenser from excessive dust, grease & sun.

Meet all applicable building codes.

Roof Attachment

Install and attach the remote condenser to the roof of the building, using the methods and practices of construction that conform to the local building codes, including having a roofing contractor secure the condenser to the roof.

 Note: If using any other condenser besides the ERC111 or ERC211, its use must be approved by Scotsman, and a head pressure control valve must be connected to the condenser coil.

Line Routing

Do not connect the tubing until all routing and forming of the tubing is complete. See the Coupling Instructions for final connections.

If two CME456R ice machines are to be installed, mark one as Ice Machine #1 and the other as Ice Machine #2. Tag their refrigerant lines the same way.

1. Each set of pre-charged tubing lines contains a $\frac{3}{8}$ " diameter liquid line, and a $\frac{1}{2}$ " diameter discharge line. Both ends of each line have quick connect couplings, the end without access valves goes to the ice maker.

Note: The openings in the building ceiling or wall, listed in the next step, are the minimum sizes recommended for passing the refrigerant lines through.

2. Have the roofing contractor cut a minimum hole for the refrigerant lines of 2". Check local codes, a separate hole may be required for the electrical power supply to the condenser.

Caution: Do NOT kink the refrigerant tubing while routing it.

3. Route the refrigerant tubes thru the roof opening. Follow straight line routing whenever possible.

If connecting two ice machines, be sure that the tubes from ice machine #1 are connected to one circuit of the condenser and the tubes from ice machine #2 are connected to the other.

 Note: Excess tubing may EITHER be coiled up INSIDE the building OR cut out prior to connection to the ice maker and condenser.

If the excess tubing is cut out, after re-brazing the tubing must be evacuated prior to connection to the ice maker or condenser.

If the excess tubing is to be coiled, spiral it horizontally to avoid excess trapping in the lines.

 Note: A 36" service loop may be placed behind the ice machine.

5. Have the roofing contractor seal the holes in the roof per local codes.

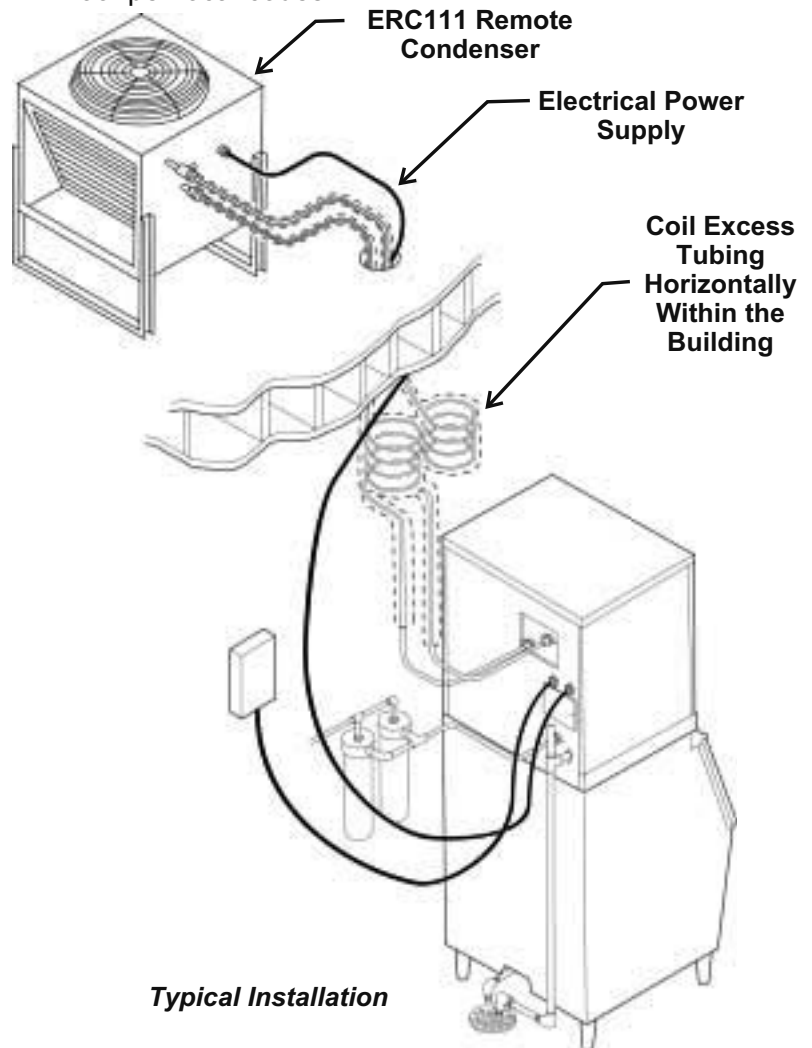

Typical Installation

CME456R

Remote Condenser Location

Use the following for planning the placement of the condenser relative to the ice machine

Location Limits - condenser location must not exceed ANY of the following limits:

- Maximum rise from the ice machine to the condenser is **35 physical feet**
- Maximum drop from the ice machine to the condenser is **15 physical feet**
- Physical line set maximum length is **100 feet**.
- Calculated line set length maximum is **150**.

Calculation Formula:

- Drop = $dd \times 6.6$ (dd = distance in feet)
- Rise = $rd \times 1.7$ (rd = distance in feet)
- Horizontal Run = $hd \times 1$ (hd = distance in feet)
- Calculation: Drop(s) + Rise(s) + Horizontal Run = $dd+rd+hd$ = Calculated Line Length

Configurations that do NOT meet these requirements must receive prior written authorization from Scotsman.

Do NOT:

- Route a line set that rises, then falls, then rises.
- Route a line set that falls, then rises, then falls.

Calculation Example 1:

The condenser is to be located 5 feet below the ice machine and then 20 feet away horizontally.

$5 \text{ feet} \times 6.6 = 33$. $33 + 20 = 53$. *This location would be acceptable*

Calculation Example 2:

The condenser is to be located 35 feet above and then 100 feet away horizontally.

$35 \times 1.7 = 59.5$. $59.5 + 100 = 159.5$. *159.5 is greater than the 150 maximum and is NOT acceptable.*

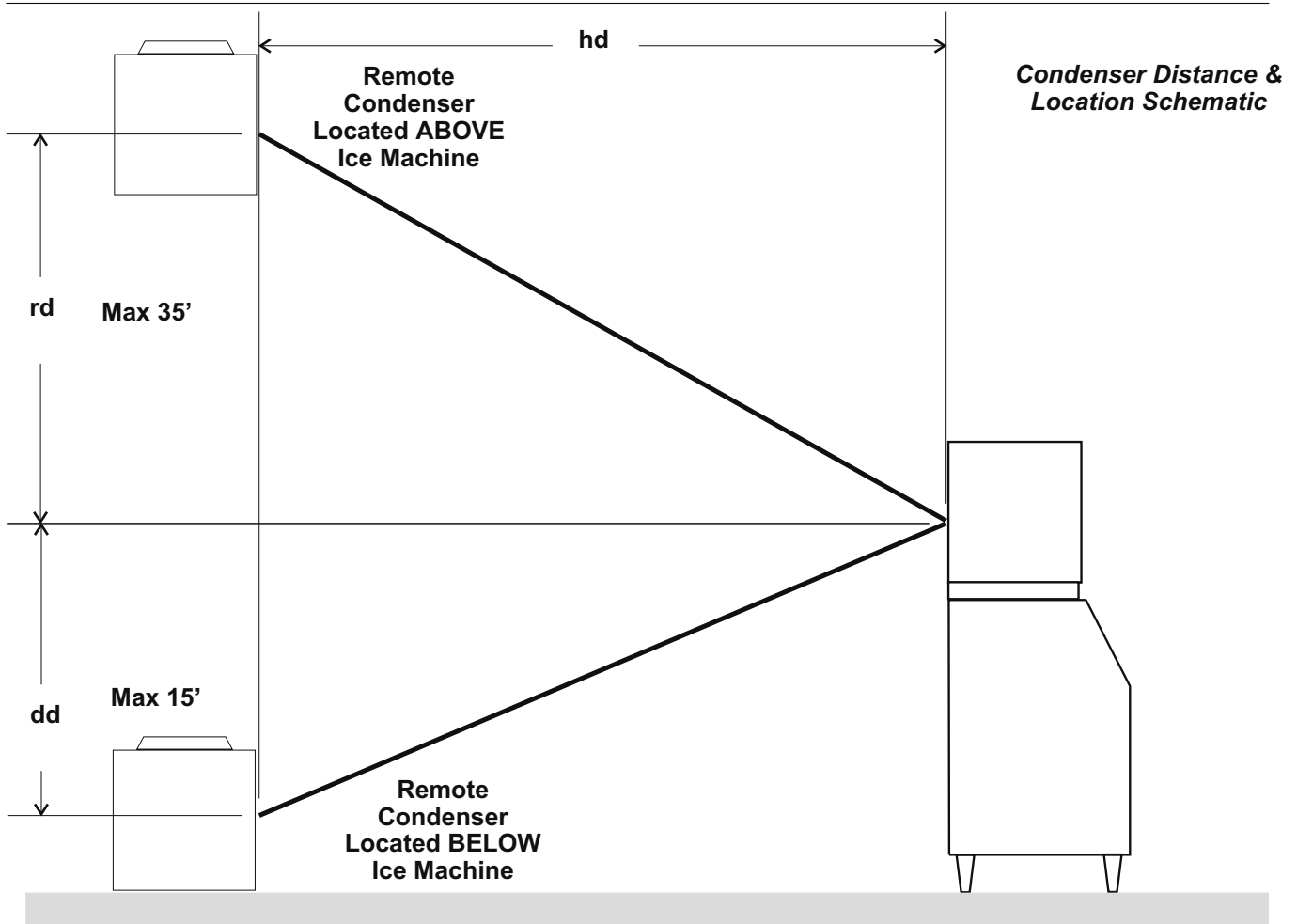

Coupling Instructions

The couplings on the ends of the pre-charged line sets are self-sealing when installed properly. Follow these instructions carefully.

These steps must be performed by an EPA Certified Type II or higher technician.

Initial Connections

1. Remove the protector caps and plugs. Wipe the seats and threaded surfaces with a clean cloth to remove any possible foreign matter.
2. Thoroughly lubricate the threads, o-rings, diaphragms and all internal coupling surfaces with polyolester refrigerant oil.



Clean and Lubricate Couplings

3. Position the fittings on the correct connections on the condenser and ice machine.
 - The 1/2" discharge line (schrader valve end) goes to the remote condenser fitting marked "discharge line".
 - The 3/8" liquid line (schrod valve end) goes to the remote condenser fitting marked "liquid line".
 - The 1/2" discharge line goes to the ice maker fitting marked "discharge line".
 - The 3/8" liquid line goes to the ice maker fitting marked "liquid line".

 Note: The system charge is contained in the receiver tank of the ice machine. Only "holding" charges are present in the "pre-charged" tubing or the condenser.

Final Connections:

- 4a. Begin to tighten the couplings together by hand. Continue to turn the swivel nuts by hand until it is certain that the threads are properly engaged.

- 4b. Using two wrenches, one to rotate the swivel nut and one to hold the tubing in place, tighten each coupling.

It is CRITICAL that ONLY the NUT on the pre-charged tube be turned, or the diaphragms will be torn by the piercing knives and become loose in the refrigeration system causing severe operational problems.



Tighten Swivel Nut

 Note: As the coupling is tightened, the diaphragms in the quick connect couplings will begin to be pierced. As that happens, there will be increased resistance to tightening the swivel nut.

- 4c. Continue tightening the swivel nut until it bottoms out or a very definite increase in resistance is felt (no threads should be showing). Do NOT overtighten.

5. Use a marker or pen to mark a line on the coupling nut and unit panel. Then tighten the coupling nut an additional one-quarter turn. The line will show the amount that the nut turns.

6. After all connections have been made, and after the liquid line valve has been opened (do not open yet), check the couplings for leaks.



Rotate Swivel Nut 1/4 Turn More

CME456R

Fan Relay Kit

When **two CME456Rs** are located near each other and are connected to the **same ERC211** remote condenser, a fan relay kit, **KCMR120** is required to operate the condenser's fan motor.

1. Attach the relay box of the KCMR120 to a location that is convenient for installation and future service.
2. Attach a solid earth ground wire to the ground screw.

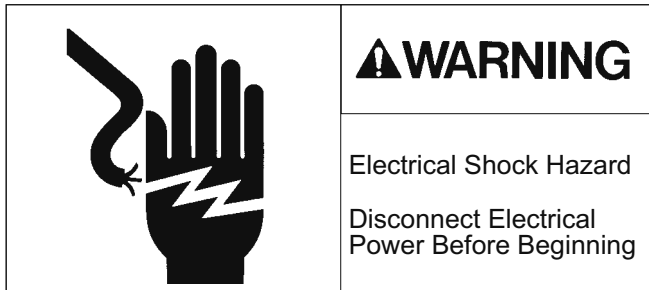

3. Route the connecting wires from the first ice machine's fan wires to the relay kit terminal strip posts marked: **No. 1 Ice Machine**.

- Put the Hot (line) wire on Terminal 1 and the Neutral wire on Terminal 2.

4. Route the connecting wires from the second machine's fan wires to the relay kit terminal strip posts marked: **No. 2 Ice Machine**.

- Put the Hot (line) wire on Terminal 3 and the Neutral wire on Terminal 4

5. Attach wires at the fan relay kit terminal strip marked: To Remote Fan, and route them to the remote condenser electrical connection.

6. Make the proper electrical connection at the junction box.

Conform to all applicable codes.

Phasing: To be certain that a reliable installation of the KCMR120 kit has been accomplished, a check of the electrical phasing is required.

If the power is not connected properly the relay will fail in a cycle or two and there may be an electrical overload.

A. Before initial start up. Compare the illustration of the KCMR120 terminal strip to the connections at the KCMR120:

- Terminals 1 and 3 must be connected to a common leg (such as L1).

- Terminals 2 and 4 must be connected to a common leg (such as N).

B. After initial start up, test with a volt meter (compressors must be ON).

1. Switch on ice maker #1, then ice maker #2.
2. Test with a volt meter between the terminals and ground.
3. List the voltages and compare them to what they should be.

Tested Voltage Should Be

- Terminal #1 to ground: 104 to 126 volts
- Terminal #2 to ground: near zero
- Terminal #3 to ground: 104 to 126 volts
- Terminal #4 to ground: near zero

Tested Voltage Was:

- Terminal #1 to ground: _____
- Terminal #2 to ground: _____
- Terminal #3 to ground: _____
- Terminal #4 to ground: _____

If the voltages are **not** correct:

A. Switch off ice maker number 2, and then switch off ice maker number 1.

B. After the units have stopped, **disconnect the electrical power. Do all wiring with the electrical power disconnected to BOTH ice makers at the source.**

C. Reverse the connections at the KCMR120 terminal strip that measured incorrectly.

D. Reconnect electrical power.

KCMR120 RELAY BOX

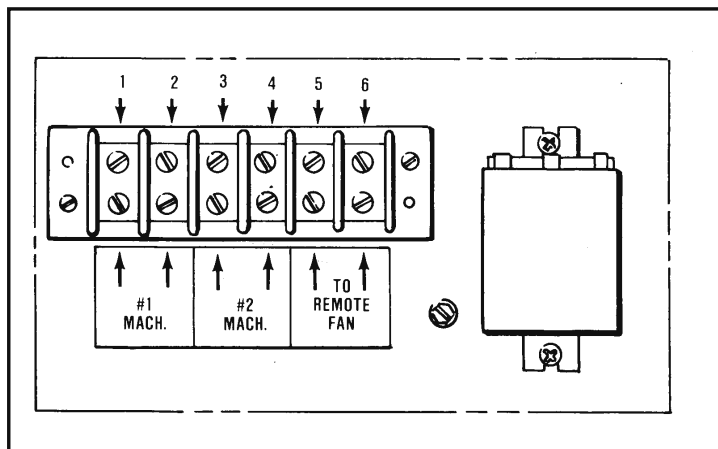

Electrical

All models must be installed with the correct wire size and type per the National Electric Code. Locate the nameplate on the back of the cabinet and find the numbers for Voltage, Phase, Minimum Circuit Ampacity and Maximum Fuse Size. Either fuses or HACR type circuit breakers may be used.

The ice maker is designed to operate on its own electrical circuit and must be individually fused. Voltage variation must not exceed the limits listed on page 2.

The remote condenser is designed to be powered from the ice machine. A separate knockout hole has been provided in the ice maker electrical junction box.

Note: Central Condensers connected to more than one refrigeration system will likely have a wiring scheme to control the fan motor. Follow those directions for condenser wiring.

Electrical connections are made in the junction box in the back of the cabinet.

1. Remove the junction box cover.
2. Knock out both holes for a field supplied strain relief.
3. Install wires and strain reliefs per code. Note: Condenser fan motor wires are tagged.
4. Connect to wires and secure ground wire to ground screw inside junction box.

All external wiring should conform to the national, state and local electrical code requirements. Usually an electrical permit and the services of a licensed electrician will be required.

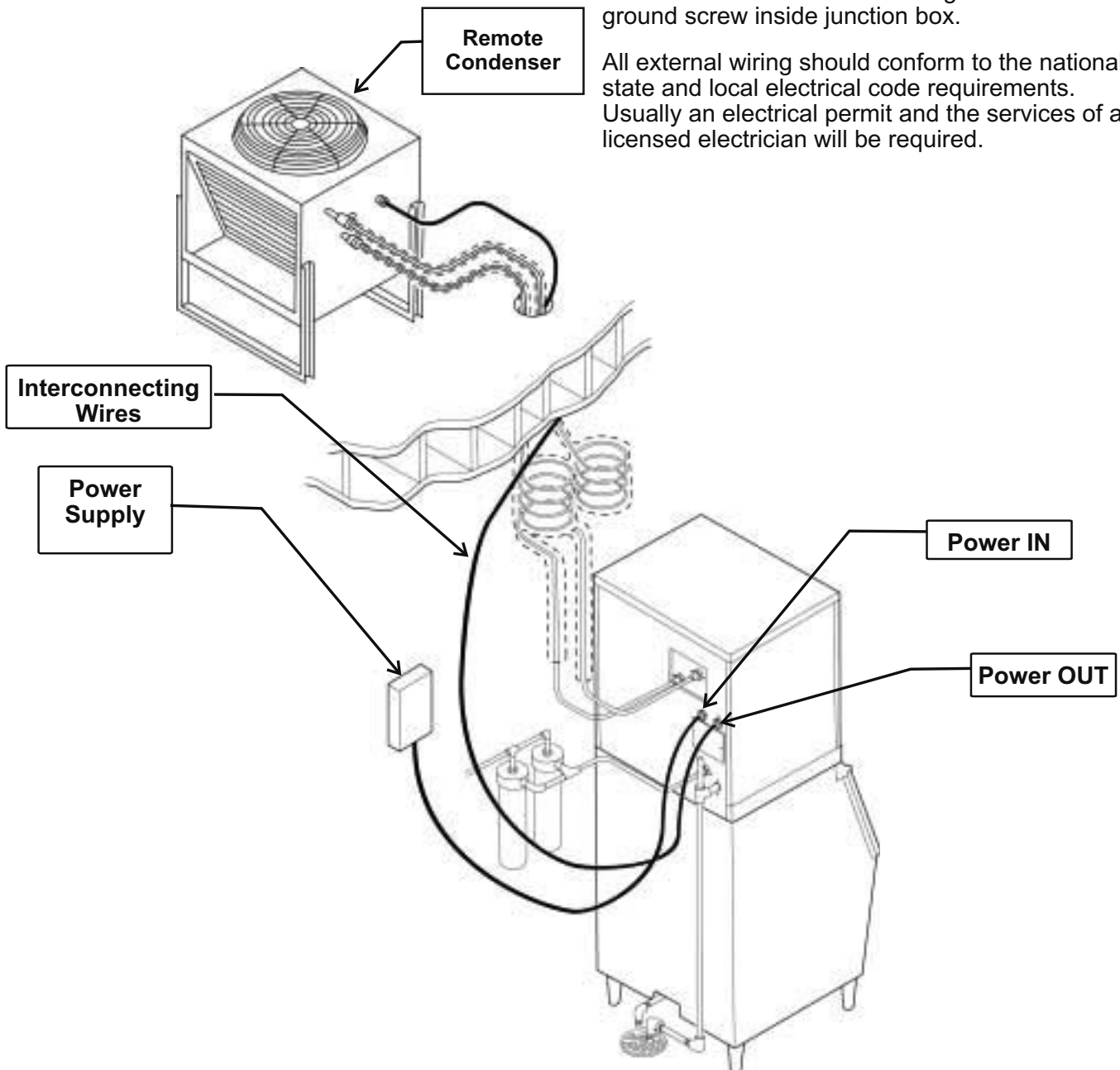

CME456R

Plumbing

All models require an adequate potable water supply and a gravity drain. The recommendations for tubing are:

- Water supply to be $\frac{3}{8}$ " OD.
- Drain to be $\frac{3}{4}$ " OD.

Note: When replacing a prior ice machine, do not take a short cut and reuse the old inlet and drain system. **INSTALL A NEW SYSTEM.**

Supply:

All models have 1 water supply connection, a $\frac{3}{8}$ " male flare at the back of the cabinet. Connect to cold potable water that has adequate pressure.

Note: Using water supply tubing smaller than $\frac{3}{8}$ " will cause severe operational issues.

Water Filters:

The water filters must flow at least 1.25 GPM or they will cause severe operational issues. Check with the filter manufacturer. When replacing a prior ice machine, do NOT assume that the water flow capacity of the filter will be adequate.

All Drain Tubing Material must be RIGID. Flexible tubing will eventually cause a restricted drain.

Drain:

All models have 1 gravity drain connection, a $\frac{3}{4}$ " FPT fitting at the back of the cabinet. Use only RIGID TUBING. Flexible tubing may be easily kinked or become cracked.

The drain tube must be vented at the back of the cabinet. Use an 18" high vent.

The ice storage bin will have a drain out the back or base, depending upon the model.

The drain for the ice machine and the ice storage bin must be SEPARATE or the ice machine's drain water may run into the bin and MELT THE ICE.

Insulation is recommended for the ice machine reservoir and bin drains.

Follow all applicable codes

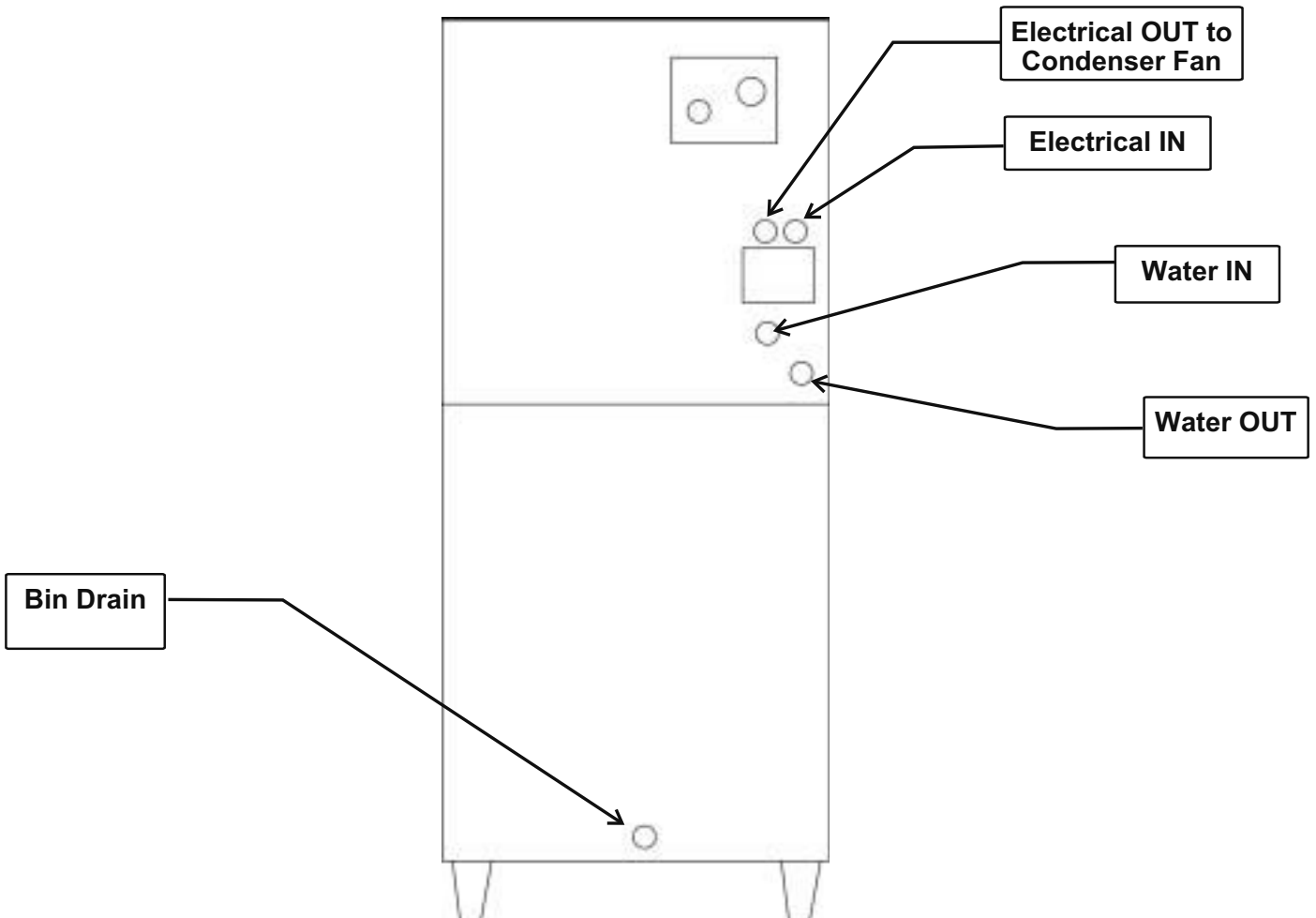

After Utility Connections

1. Wash out the bin. If desired, the interior of the bin could be sanitized.
2. Locate the ice scoop (if supplied) and have it available for use when needed.
3. Switch on the electrical power. Do not start the machine for 4 hours.
4. Go thru the final check list (below).

Final Check List:

- 1. Is the unit located indoors in a controlled environment?
- 2. Has the correct remote condenser been properly located and mounted?
- 3. Has the correct electrical power (voltage and phase) been supplied to the machine?
- 4. Have all the water supply connections been properly made with the correct size tubing?
- 5. Have all the drain connections been properly made?
- 6. Has the unit been leveled? Level the unit at the bin.
- 7. Have all unpacking materials been removed?
- 8. Is the water pressure adequate?
- 9. Is the machine secured to the ice storage bin?
- 10. Is the bin control system been properly installed?
- 11. Have the drain connections been checked for leaks?
- 12. Has the bin interior been wiped clean or sanitized?
- 13. Have any water filter cartridges been replaced?
- 14. Check all refrigerant lines and conduit lines, for vibration or rubbing and possible failure. Adjust as needed.
- 15. After 4 hours of electrical power, proceed to Initial Start Up.

CME456R

Component Location and Function

Reservoir: Contains the water used to make ice.

Water Inlet Valve: Opens to allow water into the reservoir.

Freezing Compartment: Location of the evaporators. Ice forms on the evaporators, and is released when warmed up during the harvest cycle. The freezing compartment is fully insulated for maximum efficiency.

Cube Deflector: The slots in the inclined deflector allows the water falling from the evaporators back into the reservoir, but when ice falls during harvest, the ice slides off into the bin.

Harvest Bypass Valve: Injects additional refrigerant into the harvest system.

Water Pump: Forces the water from the reservoir to the top of the evaporator(s). The motor is kept separate from the water to minimize contact with moisture.

Hot Gas Valve: Closed during freeze, it opens during harvest to divert hot discharge refrigerant gas into the inlet of the evaporators.

Purge Valve: Opens during the first part of harvest, when the water pump restarts the water in the reservoir is diverted to the drain.

Check Valves: Liquid and Discharge lines contain check valves. These control refrigerant migration during the Harvest and Off cycles.

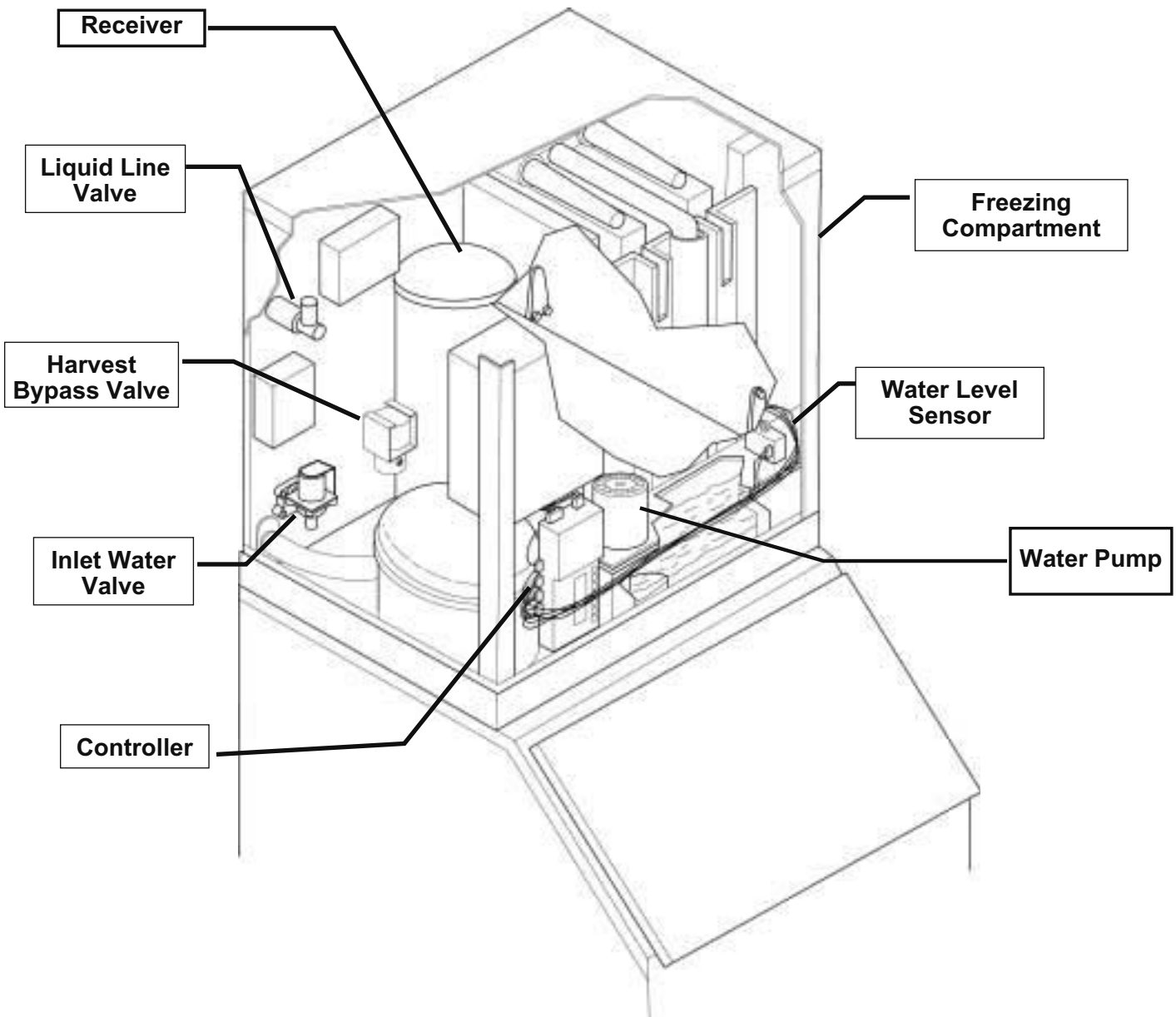

AutoIQ Controller

Indicator Lights:

- **Bin Full:** On when bin is full, goes on and off as ice falls during a harvest cycle.
- **Freeze:** On when the unit is in the Freeze cycle, blinks when a freeze cycle is pending.
- **Harvest:** On when the unit is in the Harvest cycle.
- **Clean:** On when the unit is in the Clean cycle.
- **Off:** On when the unit has been switched off, blinks when the machine is preparing to shut off.
- **Water:** On when the controller has identified a problem with the water system.
- **Refrigeration:** On when the controller has identified a problem with the refrigeration system.

Cycle Definitions:

- **Freeze:** The refrigeration system is operating to remove heat from the evaporators. The compressor, remote fan motor and water pump are ON.
- **Harvest:** The refrigeration and water systems are operating to harvest the ice cubes. While the compressor and fan motors are on for the full cycle, the water pump will be off at the beginning and the inlet water valve will switch off before the end.
- **Clean:** Water valve opens to fill the reservoir. The Water pump starts. The Clean indicator light is switched ON. A manually initiated rinse cycle flushes the system.

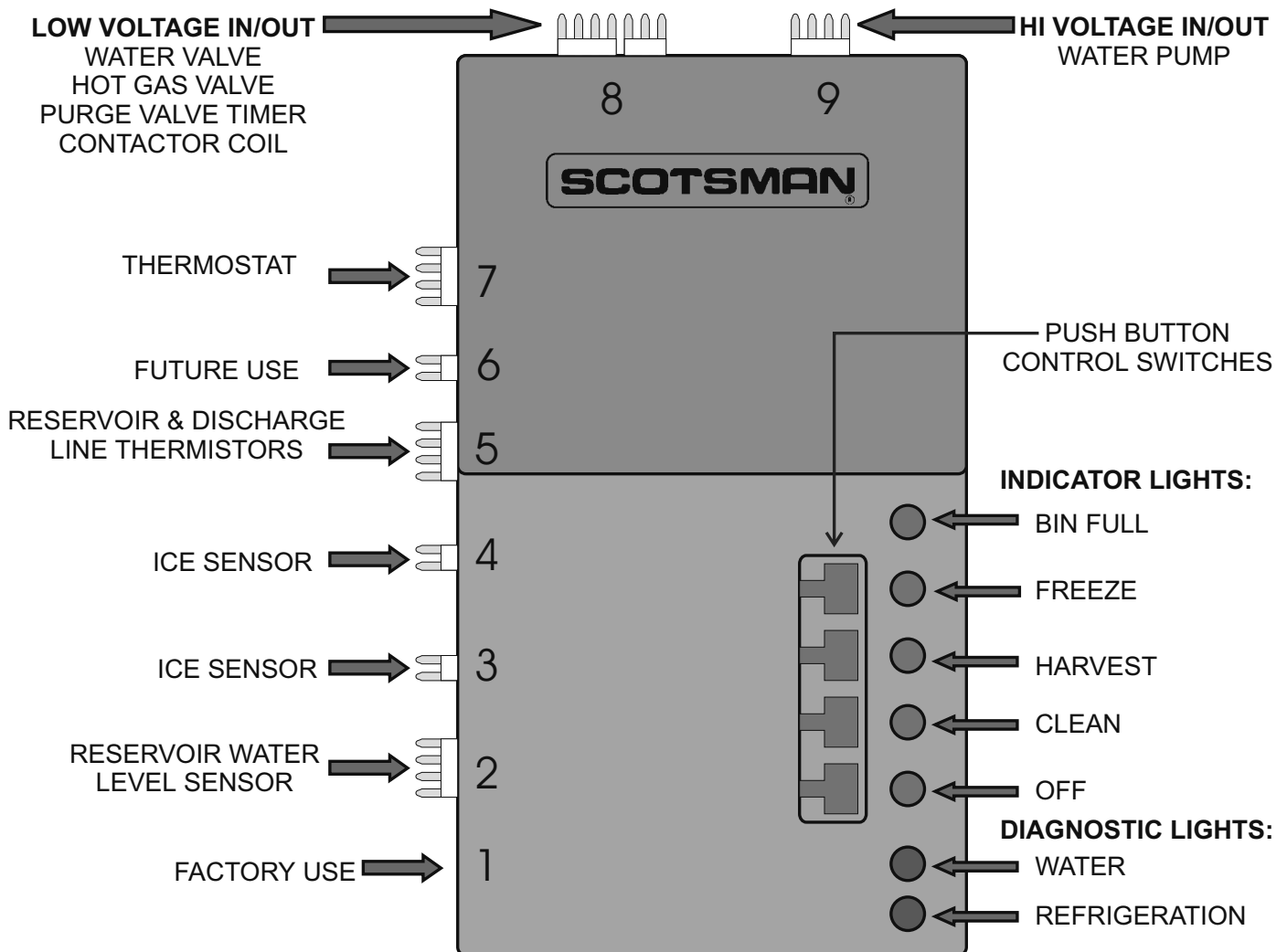

CME456R

Initial Start Up

1. Remove the front and left side panels.
2. Locate and open the liquid line valve.

Open By Turning Stem Fully Out

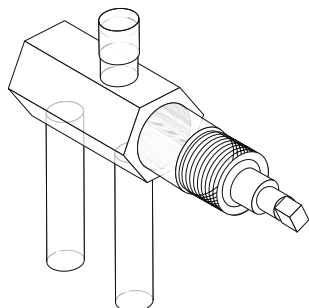

3. Double check quick-connect couplings for leaks.
4. Locate the AutoIQ Controller.
5. Check for electrical power. The Off light on the controller should be glowing.
6. Open the water supply valve.
7. Push and release the Freeze cycle push button (the Freeze indicator light will blink until the compressor starts). The next several operations are automatic.

Initial Start (30 seconds)

- The Freeze light will begin to blink.
- The hot gas solenoid valve will be open.
- The purge valve will be open
- The water pump will be on
- After 30 seconds, the hot gas valve closes
- The purge valve will shut and the inlet water valve will open to fill the reservoir. The inlet water valve shuts off when the reservoir is full.
- The compressor & remote fan motor start.

Freeze Cycle

The Freeze indicator light will come on. The unit will be in a Freeze cycle for many minutes. Slush may appear in the reservoir, it is temporary and normal.

- The pump will stop for a few seconds a few minutes into the freeze cycle
- The freeze cycle will continue until the water level in the reservoir drops to its factory set point, the first time that happens the water valve will re-fill the reservoir. The second time it happens in a freeze cycle starts the Harvest Cycle.

Harvest Cycle:

- The Harvest indicator light will be ON,

- The hot gas valve will open.
- The purge valve will be open for 74 seconds.
- The water pump will switch off. The pump will restart part way thru the harvest cycle.
- The purge valve closes.
- The Inlet water valve will open for a short time
- The Bin Full indicator light will go on and off as ice falls from the evaporators.

8. Machines are shipped from the factory with the purge level set to accommodate average water conditions. To achieve optimal machine performance, set the purge level to the minimum setting.

Note: While the amount of water purge is adjustable, only those installations with a water supply known to be excellent (very low TDS) should adjust to the minimum setting. See the next page for purge adjustment procedures.

9. After about **6 minutes** (first cycle after any restart) the machine will return to a freeze cycle.

Note: After the first harvest, the controller adjusts the harvest time as needed to release all ice.

10. The reservoir refills at the beginning of Freeze.
11. Fill out the Customer Evaluation and Warranty Registration. Send it to Scotsman.
12. Return all panels to their normal positions.
13. Inform the user of the location and telephone number of the local service company. Inform the user of the required maintenance of the machine.

Operational Notes:

1. The machine will only shut off on Bin Full at the end of the Harvest Cycle after the bin fills. That last harvest cycle will be about 6 minutes long.
2. After switching off on Bin Full, if ice is removed from the bin, the machine will not restart until it has been off for 4 minutes. If the Freeze button is pushed, the machine will restart immediately.
3. If the bin controls sense a bin full signal before any water is used (float stem up), the machine will shut off on bin full.
4. When shutting off, the compressor will run for 30 seconds (everything else will be off) and then switch off.

Adjustments

If there was a problem during Initial Start Up:

If a diagnostic light came on, check the following.

1. Water.

A water error could have been determined by the AutoIQ Controller if the inlet water valve does not fill the reservoir or if the water pump does not start and lower the water level in the reservoir. If either condition is found, the water error light will be switched on and the machine will Shut Down.

2. Refrigeration.

A refrigeration error could have been determined by the AutoIQ Controller if the water temperature did **not** drop during the freeze cycle. The Controller will next check the compressor discharge temperature. If the discharge temperature is too low, the refrigerant error light will be switched on, and the machine will Shut Down.

Note: The machine can be reset and restarted by pushing and releasing the Off push button switch, and then pushing and releasing the freeze push button switch.

Thermostatic Expansion Valve:

The TXV is not adjustable, do not attempt to adjust it.

How to Adjust the Amount of Water Purge

Adjustment is done by use of the control buttons on the AutoIQ Controller. Examine the next section to become familiar with the AutoIQ Controller before beginning.

1. If the machine is on, push and hold the OFF button for more than 3 seconds, then release it. This switches the machine Off.
2. Push and hold the OFF button for more than 3 seconds (just until all Lights flash on) then release it. Do not hold it in it too long.
3. Examine the green Lights. They should have all flashed once, then certain ones will have turned on to indicate which purge level the machine is set at. There are 5 levels of purge available:

- 1. **Maximum Purge** is when All 5 lights are ON. Use for extreme water conditions. Note: This setting may extend the Harvest cycle and reduce capacity.
- 2. **Heavy Purge** is when these 4 lights are ON: Freeze, Harvest, Clean, Off. Use for moderate to severe water conditions. This setting may extend the Harvest cycle and reduce capacity.
- 3. **Standard Purge** (factory setting) is when these 3 lights are ON: Harvest, Clean, Off. Use for typical water conditions.
- 4. **Moderate Purge** is when these 2 lights are ON: Clean, Off. This is for good water conditions.
- 5. **Minimum Purge** is when this light is ON: Off. For excellent water conditions.

Adjust by pushing and releasing the Freeze button. Pushing and releasing the Freeze button increases the purge one level up to the maximum, then it goes to the minimum.

4. The machine will automatically restart after 60 seconds of no switch inputs, or restart the machine by pushing in and holding the Off button for more than 3 seconds, then releasing it. The unit will then be Off. From there the machine may be placed in a freeze cycle by pushing and releasing the Freeze button.

CME456R

How To Operate The AutoIQ Controller

The AutoIQ Controller is a microprocessor based device that receives input from several sources and switches various components on and off.

Its manual control is thru the use of the Push Button Control Switches

1. **Freeze Button.** Pushing and releasing this button starts or restarts the machine. The AutoIQ Controller remembers what cycle it was last in and returns to that cycle.

2. **Harvest Button:** Pushing and releasing this button will cause the machine to go directly to a Harvest Cycle. Can be done from Freeze or Off. The machine will switch Off at the end of the Harvest cycle.

3. **Clean Button:** Pushing and releasing this button will cause the machine to empty the reservoir, refill and leave only the water pump on for circulation of ice machine cleaner. After the ice machine cleaner has circulated for about 10 minutes a second push of this button will switch on the rinsing system to flush out the dissolved scale and ice machine cleaner.

4. **Off Button:** Pushing and releasing this button will switch the machine OFF at the end of the next cycle. If the button is pushed and HELD for more than 3 seconds, the unit will switch off immediately.

To Reset Errors: First push and release the Off button, then push and release the Freeze button.

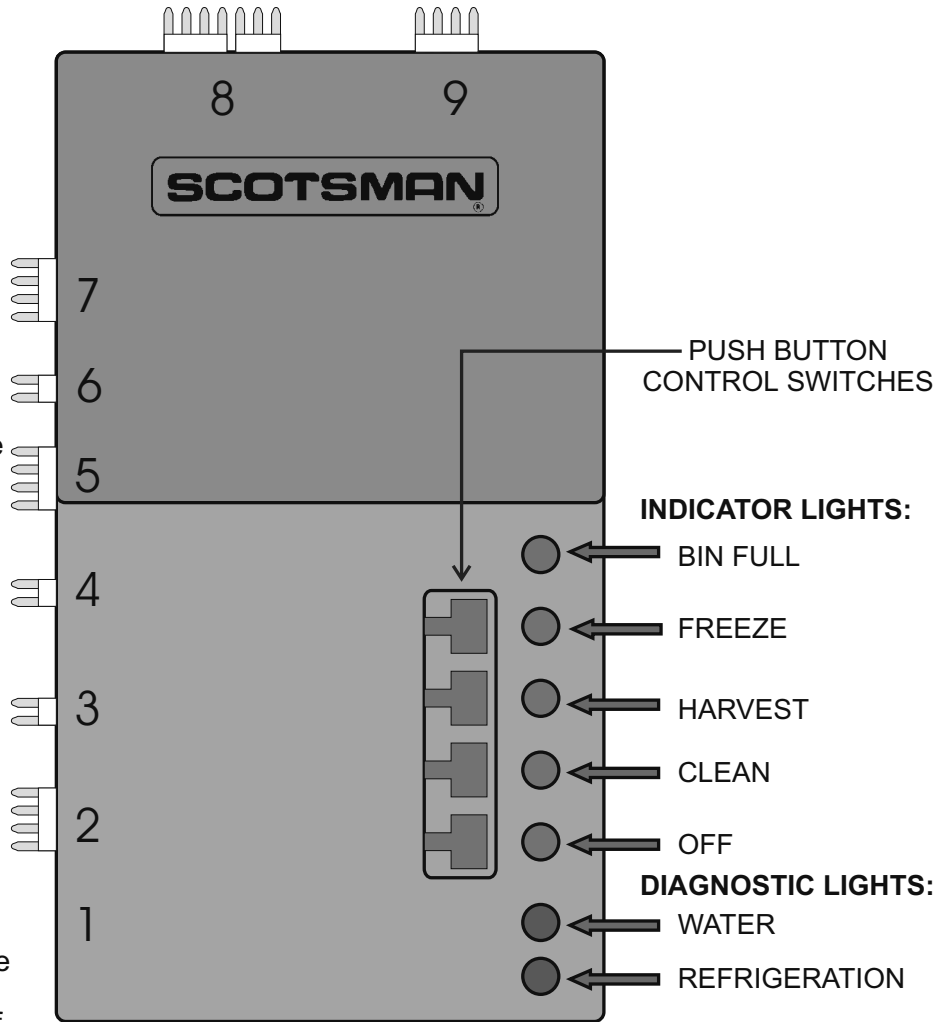

How The Electronic Cuber Works

This section is intended for the technician. It is not necessary for the normal operation and maintenance of the machine.

Refrigeration System:

The refrigeration system is similar to that of most commercial cube ice machines. Heat is removed from the water and discharged out the condenser during the freeze cycle. As liquid refrigerant passes thru each Thermostatic Expansion Valve, it enters the bottom of the evaporators, and ice will form at the bottom first.

When cubes need to be released (Harvest) the Hot Gas Valve is opened and Hot discharge gas flows from the compressor through the check valves to the evaporator inlets. At the same time, a Harvest Bypass Valve opens for a few seconds to add the refrigerant needed for harvest. After that the Harvest Bypass Valve and the closed Discharge Check Valve keeps the refrigerant in the condenser out of the Hot Gas Circuit.

This warms up the evaporators and the surface of the ice frozen to the evaporator surface melts. Ice then falls into the bin.

The liquid line Check Valve prevents liquid migration at low ambients during the Off cycle.

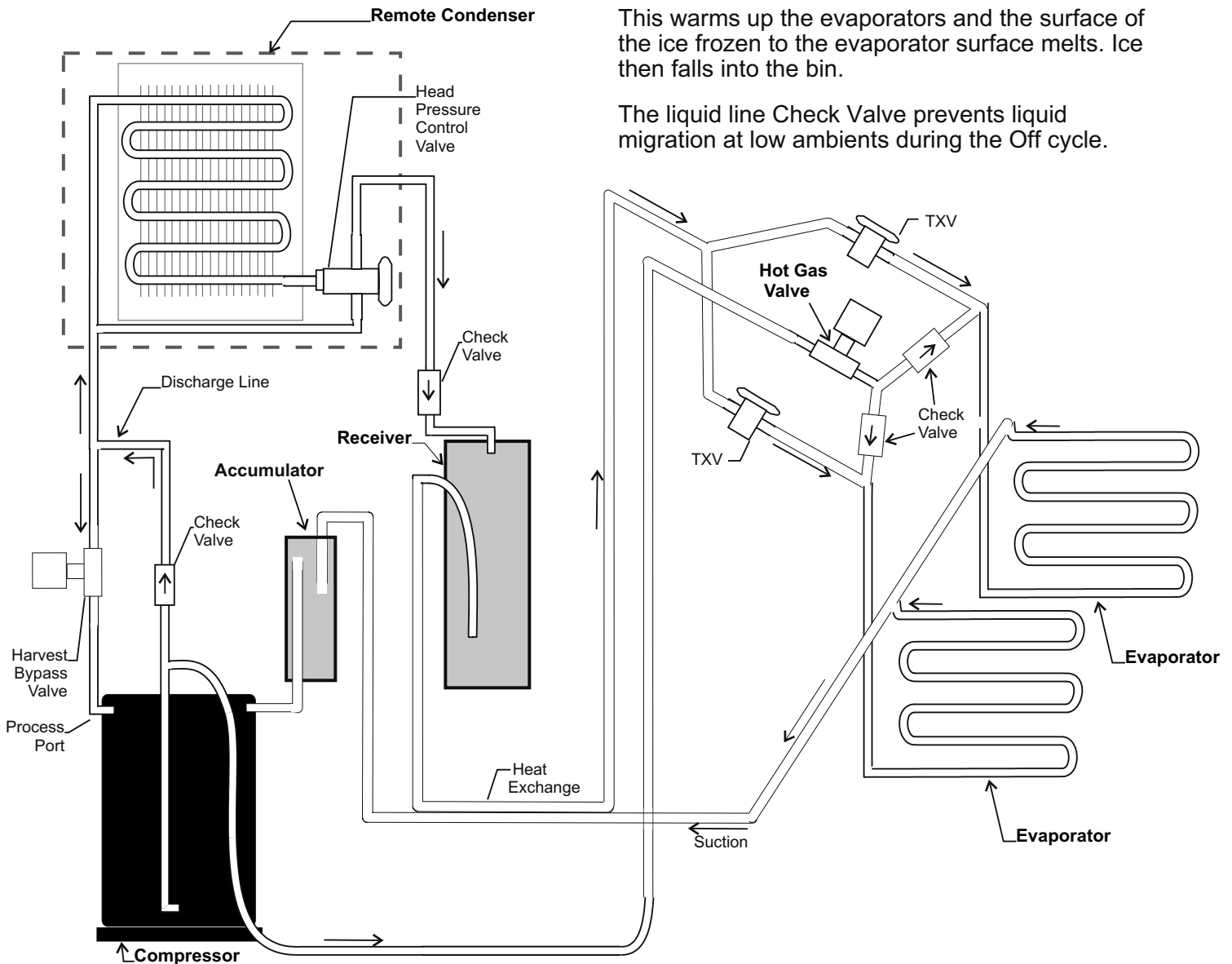

Refrigeration Schematic

CME456R

How The Electronic Cuber Works

Water System:

Freeze:

The water pump forces water to the top of the evaporators. The un-frozen water falls thru the cube deflectors and back into the reservoir. As water is turned into ice, the water level in the reservoir falls, and the machine will re-fill the reservoir once during the freeze cycle.

At the point where the cubes are fully formed, the water level sensor indicates to the AutoIQ Controller that it is time to begin the Harvest cycle.

Harvest:

At the beginning of Harvest, the water pump shuts off and the purge valve opens. The purge valve remains open for 40 seconds. No water will drain until the water pump restarts. The water pump will start at a variable time depending upon the amount of water rinse that has been set.

After the purge valve has closed, the inlet water valve opens and water flows into the ice machine. The water valve will NOT be open the complete length of the harvest cycle.

The inlet water valve will "top off" the reservoir at the beginning of the next freeze cycle.

The AutoIQ Controller operates the ice machine by monitoring several input measures and switching various loads on and off.

Controller Inputs:

1. **Reservoir water temperature.** This is measured by a thermistor located in the water pump outlet.
2. **Discharge line temperature.** This is measured by a thermistor located on the compressor discharge line.
3. **Water level.** This is measured by an infrared sensor and float. The float rises and falls with the water level, and switches the sensor on and off as it moves.
4. **Bin fill level.** This is measured by a set of electric eyes in the cube outlet port. If ice fills the bin, it will block the "eyes".

Some units are equipped with a bin thermostat, those units use the thermostat to switch the machine on and off. The electric eyes in the cube outlet port will also control the machine if the bin thermostat sticks in an ON position.

5. **Time.** The controller measures and compares how long it takes for various events to happen. It stores that data for future reference.

Controller Outputs:

A. 24 volt:

- 1. Lights
- 2. Inlet water valve
- 3. Hot Gas Valve
- 4. Contactor Coil
- 5. Harvest Bypass Valve Coil

B. High Voltage

- 1. Water Pump
- 2. Purge Valve

Technicians Only: Freeze Cycle Sequence

Assuming the machine has been operational, the Freeze cycle begins with the end of the Harvest Cycle:

- Water Inlet Valve is Closed
- Water Pump is ON
- Compressor is ON
- Hot Gas Valve is Open

AutoIQ Controller Operation, Beginning freeze:

1. Switches on Freeze indicator light and shuts off the hot gas valve.

2. Opens the water valve to top off the reservoir. The controller checks that water fills the reservoir, if it does not fill up within 130 seconds, the controller shuts the machine down. It will automatically try to restart in 20 minutes.

3. Measures and stores the discharge temperature.

4. If the discharge temperature exceeds the design maximum, shuts the machine down on a Refrigeration Error.

5. Checks for a "bin full" signal throughout the cycle.

6. Measures the reservoir water temperature. If the machine is operating correctly, the reservoir water temperature will fall at a standard rate. The AutoIQ Controller will be checking to see if the water temperature fall matches that rate.

If not, it re-checks the discharge line temperature. If too low, it Shuts Down on a Refrigeration Error. If the discharge temperature is acceptable, the water system is checked by shutting off the water pump and determining if the water level goes up enough. If it does not, the inlet water valve will open again to fill it. If, after restarting, the water level does not drop, it is assumed that there is a water pump problem and the machine Shuts Down on a Water Error.

If the water level does "measure up" the water pump is restarted and the AutoIQ Controller then measures how long it takes to lower the water level. If the water level does not fall, the machine Shuts Down on a Water Error.

7. Once per freeze cycle the machine will shut off the water pump. It **only** does this when the water temperature reaches a preset minimum. The pump will only be off for a few seconds.

8. As the machine makes ice, the water level in the reservoir will ultimately fall to the Harvest Level. The first time that happens per freeze cycle the inlet water valve is re-opened and the reservoir is refilled. The next time it happens, the unit will go into a harvest cycle.

 Note: If the freeze cycle exceeds the preset Maximum (45 minutes), the Controller will Shut Down the machine and switch on the Refrigeration Light.

9. The end of Freeze cycle will see the machine in this state:

- Water level = below harvest position
- Water inlet valve will be off
- Water pump will be ON
- Compressor will be ON
- Hot gas valve will be off

At this point Harvest begins and the AutoIQ Controller switches the Harvest indicator light ON.

Restarts:

If the machine is restarting after it has shut off because the bin was full, the first freeze cycle sequence is like this:

1. Purge valve is open.
2. Pump starts.
3. Purge valve closes.
4. Water valve opens to fill the reservoir.
5. Compressor starts.

 Note: If there is a power interruption, after power is restored the machine will restart, go thru a brief Freeze cycle and go thru a 6 minute Harvest cycle.

Error Restarts:

The machine automatically attempts to restart 50 minutes after a shut down. If another problem occurs in the next cycle, the machine will attempt one more restart. If another problem occurs in the next cycle, the machine will shut off and must be manually reset.

CME456R

Technicians Only: Harvest Cycle Sequence & Other Notes

Harvest

The Purge Valve will be open for 40 seconds.

The water pump shuts off, it will restart before 40 seconds, the restart time is based on the Purge Level Setting.

The pump restarts and pumps water out of the reservoir until the purge valve closes.

The inlet water valve will stay on for about 30 seconds to add enough water to assist with harvest.

The Hot Gas Valve will be open for the entire length of the Harvest Cycle.

The Harvest Bypass Valve will be open for a few seconds (between 4 and 12, depending upon discharge temperature) at the beginning of the Harvest Cycle.

During the Harvest Cycle, ice will be falling from the evaporators and between the ice sensor's electric eyes. The AutoIQ Controller monitors the ice falling and uses that information to determine the next harvest cycle length.

The first Harvest after a restart will take about 6 minutes to establish a base line, then the time it took to release that ice is used to determine the next harvest cycle's length.

The maximum harvest time is 14 minutes.

If no cubes fall (or are sensed) by the end of the Maximum Harvest Time, the machine senses a Refrigeration error. If the next cycle also produces a Refrigeration error, the machine will shut down.

Note: The last Harvest cycle before shutting off on Bin Full will be about 6 minutes long.

Note: The machine will not restart for 4 minutes after switching off on Bin Full, unless the Freeze button is pressed.

Bin Full: The controller will switch on the compressor for 30 seconds after 25 hours of off time to keep refrigerant out of the compressor oil.

Continuous Run Time

A unit that operates 24 hours a day 7 days a week is too small for the user's needs. To maintain harvest integrity, the controller will extend the harvest time to 6 minutes every 15th consecutive harvest cycle.

Bin Thermostat:

In normal ambients the thermostat will react to ice on the bulb in a few seconds. Reaction after removal will take about a minute under normal conditions, and longer in colder rooms.

Diagnostic Light Code Table

If a Diagnostic Light	Water Light	Refrigeration Light
Blinks once and repeats	Water pump will not start	Very long ice harvest
Blinks twice and repeats	Lack of water fill	No harvest of ice
Blinks three times and repeats	not used	High Discharge Temperature
Is ON all the time	Water valve leaking thru rapidly	Check for low discharge temperature or long freeze cycle
Both ON all the time	Check for thermistor set unplugged or failed	

.....
Note: Diagnostic lights remain on until the controller is manually reset or until it successfully restarts the machine.
.....

Sanitation and Cleaning

It is the User's responsibility to keep the ice machine and ice storage bin in a sanitary condition. Without human intervention, sanitation will not be maintained. Ice machines also require occasional cleaning of their water systems with a specifically designed chemical. This chemical dissolves mineral build up that forms during the ice making process. Sanitize the ice storage bin as frequently as local health codes require, and every time the ice machine is cleaned and sanitized.

The ice machine's water system should be cleaned and sanitized a minimum of twice per year.

In Place Cleaning of the Water System:

1. Remove all ice from the bin.
 2. Remove the front panel.
 3. Push and release the Harvest button (this releases any ice on the evaporators and warms them up).
 4. Wait for the machine to finish the Harvest cycle (the machine will stop).
 5. Remove the freezing compartment cover and both inner splash panels.
 6. Remove the sump cover by unplugging the wire harness from the water level sensor, then removing the screw holding the cover to the reservoir.
- Unwind the wires from the sump cover and lift the sump cover and water level sensor up & out of the machine.
7. Pull the float off the float stem. Squeeze the water sensor mounting tabs together and remove the sensor from the sump cover.
 8. Remove the cube deflector from the machine by lifting it up at the front, rotating it 90° clockwise, then pulling it out of the machine.
 9. Place the cube deflector, sump cover, float, float stem and both inner splash panels into a separate, clean container.
 10. Mix a solution of 8 ounces of Scotsman ice machine cleaner and 1 gallon of warm (95-115°F.) water. Use the solution to scrub the cube deflector, float, float stem, sump cover & splash panels in the separate container.

CAUTION	Scotsman Ice Machine Cleaner contains acids. Acids may cause burns.
	If concentrated cleaner comes in contact with skin, flush with water. If swallowed, do NOT induce vomiting. Give large amounts of water or Milk. Call Physician immediately. Keep out of the reach of children.

11. Reassemble the water level sensor to the sump cover. Insert float stem through sensor and push float onto stem. Reconnect sensor wires and place assembly onto reservoir.

12. Push and release the Clean button. The Clean indicator light will blink and the pump will restart.
 13. After water stops flowing in, lift sump cover and pour 12 ounces of Scotsman Ice Machine Cleaner into the reservoir water. Return the sump cover and freezing compartment cover to their normal positions.
 14. After the ice machine cleaner has circulated for 10 minutes, push and release the Clean button. This starts the rinsing process. The Clean indicator light will be ON. Note: The rinse process flushes any residual cleaner out of the ice machine's water system.
 15. Continue the rinsing process for 20 minutes, then push the off button to switch the machine off.
 16. Go to the next step to sanitize the machine or go to step 23 to finish the cleaning process.
 17. Mix 2 gallons of Sanitizer solution. Follow local codes for Sanitizer.
- Note: A possible sanitizing solution may be made by mixing 1 ounce of liquid household bleach with 2 gallons of warm (95-115°F.) potable water.
18. Push and release the Clean button again.
 19. After water stops flowing in, pour 24 ounces of Sanitizer solution into the reservoir water.
 20. After the solution has circulated for 10 minutes push and release the Clean button. This starts the rinse process. Sanitize the ice storage bin while waiting.
 21. Continue the rinsing process for 20 minutes, then push the off button to switch the machine off.

22. Remove the freezing compartment cover and spray or wash all interior surfaces of the freezing compartment including the inside of the cover with sanitizer solution.
23. Repeat step 6 and thoroughly immerse the splash panels, float, float stem, sump cover and cube deflector in the sanitizing solution.
24. Return the cube deflector, inner splash panels, water sensor, float and sump cover to their original positions. Secure sump cover with the original screw.
25. Reconnect wire harness to water level sensor.
26. Return the freezing compartment cover to its original position. Push and release the Freeze button.
27. Return the front panel to its normal position and secure it to the machine with the original screws.

CME456R

Additional Maintenance

Additional Maintenance: Water Distributors Water Level Sensor

It may become necessary to remove the water distributors from the top of the evaporator and clean (de-mineralize) them outside of the ice machine.

1. Remove front panel.
2. Push and release the OFF button.
3. Remove the evaporator cover.
4. Lift the water distributors up at the center until they snap apart.

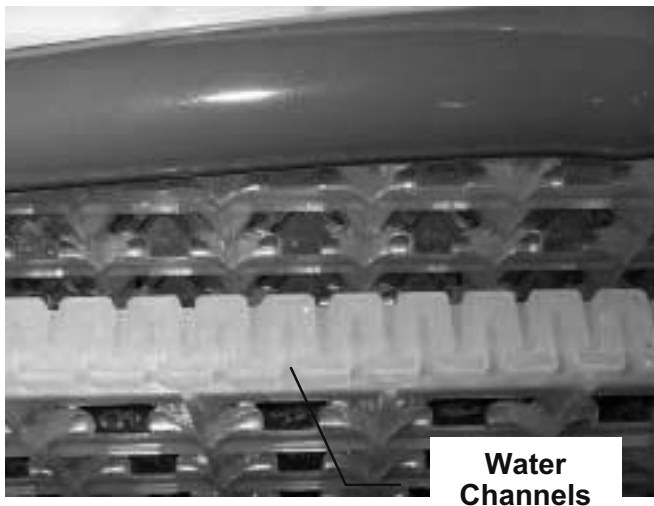

5. Repeat for all evaporators.
6. Examine the top of the evaporators. The Water Distribution Channels must be free from mineral build up. If build up is evident, scrub the channels with Scotsman Ice Machine Cleaner and a plastic bristle brush.
7. Examine the water distributors. Although they are made of a material that is resistant to mineral build up, some may be present. Soak or scrub the distributors in or with a solution of Scotsman Ice Machine Cleaner and warm potable water.
8. Return the water distributors to their normal installed position.
9. Push and release the clean button to flush the water system.
10. After the machine stops, push and release the Freeze button.
11. Replace the evaporator covers.
12. Replace the front panel.

Clean the lenses inside the water level sensor.

1. Remove the sensor from its installed position.



2. Remove dust cover.
3. Wipe lenses clean with a cotton swab.
4. Reverse to reassemble.

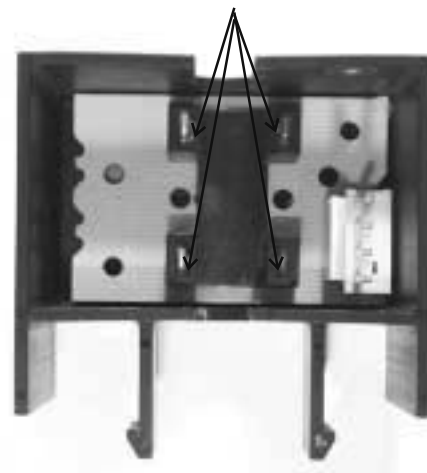
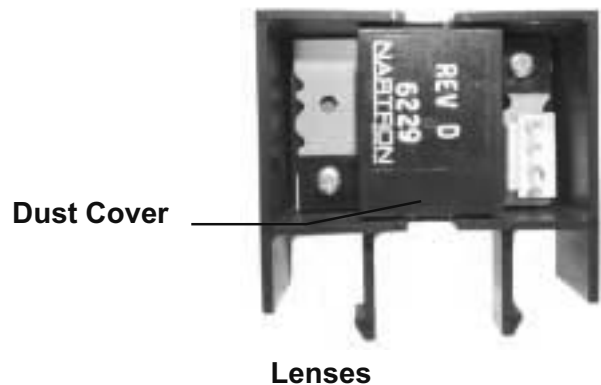

Additional Maintenance: Inlet Water Valve Screen

The inlet water valve has a screen on its inlet side to keep debris from flowing into the valve. In some cases, this screen may become clogged or restricted by debris build up. Check for the proper water flow:

Flow rate is 1.25 G.P.M.

1. Remove front panel.
2. Obtain a 16 ounce cup and a watch.
3. Pull the water discharge tube out of the reservoir and place it in the cup.
4. Push and release the Harvest button.
5. If working properly, the water valve will fill an 16 oz cup in about 10 seconds. Be prepared to push the Off button! If it does not, the water valve inlet or other water device is restricted.

To Check the Inlet Water Valve Screen.

1. Disconnect the electrical power.
2. Shut off the water supply.
3. Remove the front panel.
4. Unplug the electrical connection of the inlet water valve.
5. Remove the screws holding the inlet water valve to the cabinet.
6. Remove outlet tube from inlet water valve.
7. Rotate inlet water valve from inlet fitting and remove valve from machine.
8. Examine the inlet screen, if dirty, brush off screen. Note: Screen is not replaceable, and may only be removed by taking off the covering bracket. The bracket forms part of the inlet water system, and must be water tight to the valve body, removal is not recommended.
9. Reverse to reassemble.

To drain reservoir (if desired):

1. Remove front panel.
2. Push and hold the Off button.
3. Push and hold the Clean button until the reservoir is empty.
4. Push and release Freeze button.
5. Return the front panel to its original position.

To Sanitize the Ice Storage Bin

1. Remove all ice.
2. Remove baffle.
3. Switch ice machine OFF or wait for it to be in a cleaning cycle.
4. Mix a 1 gallon solution of warm (95-115°F.) water and sanitizer. Follow local codes for sanitizer.
5. Wash or spray the entire interior of the ice storage bin with the sanitizer solution. This includes the bottom of the ice machine and the inside of the door, the door gaskets (if any) and door frame.
6. Pour excess sanitizer into the bin to flush the drain system.
7. If the approved sanitizer requires a rinse, rinse all interior surfaces with potable water.

CME456R

Additional Maintenance: Ice Sensors, Condenser

The ice sensors use a system of infrared emitting and receiving components to sense the build up of ice in the bin. They are located at the bottom of the ice outlet port. They must be free of mineral build up to function properly. To check:

1. Remove front panel.
2. Push and release the harvest button.
3. Wait for the machine to stop.

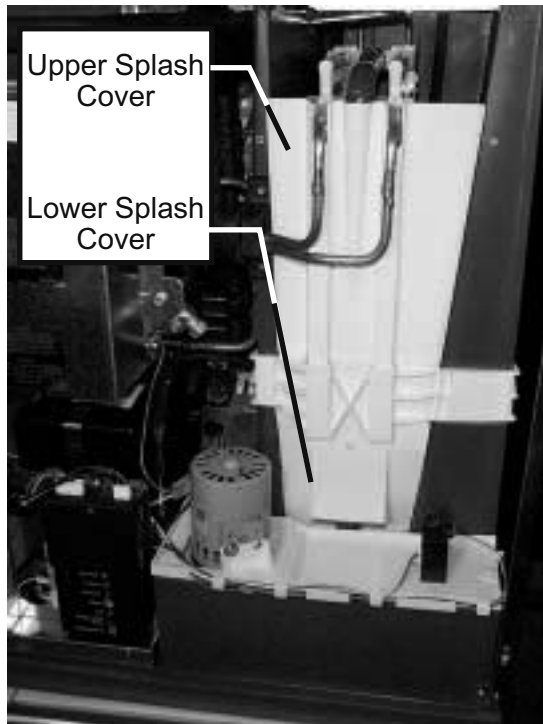

4. Remove the evaporator cover.

5. Locate the front ice sensor.

Push the sensor from the front (at the wire area) to the back until it releases from the holder.

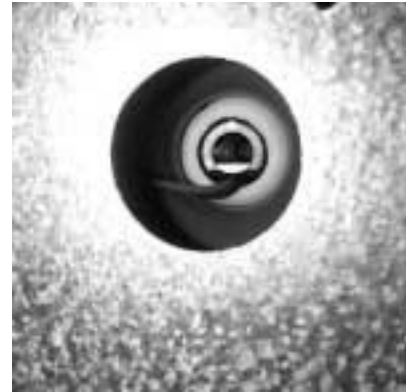

Back Ice Sensor Port (step 6)

6. Locate the back ice sensor
Pull on the rectangular tab to release it from its mounted position.

7. Examine the bottom of the brackets, there are two sensors in each bracket, check that they are clear of mineral build up. They may be wiped clean with ice machine cleaner to assist in removal of the build up.

Note: Do NOT use abrasive materials or cleaner on the ice sensor lenses. A soft toothbrush works well to get into the hard to reach spots.

8. Reverse steps 1-6 to reassemble.

To Clean the Remote Air Cooled Condenser

1. Disconnect and lock out the electrical power.
2. At the remote condenser, check for loose debris on the roof, remove any near the condenser.
3. Check the fan blade and condenser for grease or dust build up. Brush the intake surfaces (outside) of the condenser coils with a nylon brush to remove surface dirt. Use a fin comb to straighten any bent fins.

Note: Air flow is UP, towards the fan. If grease is present, use coil cleaner on the condenser. Be sure to wipe up any excess coil cleaner.

4. Reconnect the electrical power.



Lens Location in Ice Sensor

Service Diagnosis: Diagnostic Light Analysis

Problem or Symptom	Possible Cause	Probable Correction
Machine is off	Bin is full	Use some ice
	Bin full light is ON, no ice in cube port	Check optional thermostat, check ice sensor lens for scale.
	Bin thermostat is closed	Check thermostat
	Power is off, check Lights.	If all Lights are out, check power supply, restore power if off
	Transformer is open	If all Lights are out and there is power, check transformer output for 24 vac
	Unit has been switched off or has finished a Clean cycle, Off Light is glowing	Push and release Freeze button
	Unit has Shut Down	Check for Refrigeration or Water Error
Unit is off on a Water Error	Water supply inadequate	Check water Light, if the Light blinks 2 times and repeats, check the water inlet valve for proper water flow.**
	Water pump malfunction	Check that pump hose is attached and if pump is plugged in and working.
	Water level sensor may have failed.	Check float stem, reset machine. If it will not reset or gives another water error and everything else is OK, replace the water level sensor.
Unit is off on a Refrigeration Error	Low discharge or long freeze cycle	Check refrigeration Light. If the Light is glowing, there is a probable refrigeration problem - fan motor could have failed.
	Harvest problem	Check refrigeration Light. If the Light blinks once and repeats, look for a harvest problem. where some cubes were sensed.**
		Check refrigeration Light. If the Light blinks two times and repeats, look for a harvest problem. - no cubes sensed**
	High Discharge Temp	Check refrigeration Light. If the Light blinks 3 times and then repeats, check for a reason for high discharge temperatures - fan motor hot ambient.
	Unit does not go into harvest - exceeds maximum freeze time	Push and release Off button. Push and release Freeze button. Check operation.
		Push cube size float down and check operation.
Exceeds maximum harvest time	Check for cause of long harvest cycle**	
Unit runs and both Diagnostic lites are ON	Temperature sensors out of range	Replace the temperature sensor set (water and discharge).
Same, only 1 light on	Reservoir temp. wrong	Check water temp. and sensor.

* Machine may be reset by pushing and releasing the Off button, then pushing and releasing the Freeze button. ** See following pages

CME456R

Service Diagnosis

Problem or Symptom	Possible Cause	Probable Correction
Unit is off because of a "Harvest Problem"	Ice sensors did not sense ice falling, unit stayed in harvest until the maximum harvest time ran out.	Check ice sensors. If the bin full light is on or blinking the bin controls may be dirty. Clean if dirty. The board and bin controls may also need to be checked.
		Check evaporators for lime scale build up. Clean evaporators and bin controls if dirty.
		Push and release Off button. Push and release Freeze button. Check machine operation. Check if ice is made and harvests.
	Bin controls or AutoIQ Controller may have failed.	See "Unit does not shut off" below..
	Other components may have failed	Check the next page
Cubes are too large	Cube size control float is sticking.	Check/clean
	Inlet water valve leaking thru (slowly)	Check hose from water valve for slow drip. Replace valve if dripping.
Cubes are too small	Not enough water	Check for leak in reservoir
		Check for a leak thru the purge valve
Low ice capacity	Dirty condenser	Clean condenser
	Recirculation of air	Block air re-circulation or move condenser
	Low refrigerant charge	Check system. If there is a low charge, find the leak, recover the refrigerant, repair the leak, replace the dryer, evacuate and weigh in the nameplate charge.
	Too much water	Check for inlet water valve leak thru
Unit does not shut off	Ice sensing system may have failed.	Check controls. Unplug thermostat and check bin full light, if off, place something between the electric eyes. The bin full light should begin to blink (after 20 seconds of continuous blockage it will glow steadily). If not, check operation of electric eyes by unplugging #4 and jumping out the two pins on the controller (touch the tool to the cabinet to discharge static electricity before contacting the controller). If the bin full light blinks, replace the bin controls. If it does not blink, replace the controller. Note: Leaving #4 unplugged and jumped for 20 seconds will shut the machine down on a bin full (at the end of the harvest cycle). It will restart after 4 minutes or may be reset by pushing the Freeze button.

Service Diagnosis: Components

Problem or Symptom	Possible Cause	Probable Correction
Fan motor does not turn.	Open motor windings, or seized bearings	Replace fan motor
	No power to fan motor	Contactors may not close.
Pump motor does not turn	Open motor windings, or seized bearings	Replace pump
	No power to pump	Check electrical connections. In Freeze, the pump should have power to it. If not, replace the AutoIQ Controller.
Hot Gas Valve does not open.	Open solenoid coil.	Replace hot gas valve
	Stuck valve	Replace hot gas valve
	No power to coil in Harvest	Check wire connections, if ok, replace AutoIQ Controller
Hot Gas Valve leaks thru (warm tube temperatures on both sides of valve during freeze)	Mechanical problem in valve	Replace valve
Water Inlet Valve does not open	Open solenoid coil	Replace valve
	Stuck valve	Replace valve
	No power to valve (best checked at the beginning of Freeze)	Check wire connections, if ok, replace AutoIQ Controller
Water Inlet Valve does not flow enough water	Restriction in water supply	Check water filters and/or inlet screen.
Water Inlet Valve leaks thru	Mechanical problem in valve	Replace valve
Compressor does not work	Unit in Clean cycle	Push and release Freeze button.
	Contactors coil open	Replace contactor
	Open starting components	Check and replace
	Open windings	Check and replace compressor
	Internal valve failure	Replace compressor

CME456R

Service Diagnosis

Problem or Symptom	Possible Cause	Probable Correction
Poor Harvest	Scale in water system.	Clean water system.
	Water or Air Temperatures too cold	Check temps. Unit cannot operate with water and air temps below stated limits.
	Low system charge	Recover and weigh charge.
	Bypass solenoid does not open	Check solenoid operation
	Check valve leaks back	Replace check valve
	Hot gas valve does not open	Check for power to the coil, if there is power, replace the hot gas valve
	Head pressure control valve does not maintain enough pressure (in freeze)	Replace the head pressure control valve
Low capacity	High discharge pressure, from a dirty condenser or faulty fan motor	Clean the condenser, repair the fan motor
	Extreme hot location	Relocate the cabinet
	Extremely hot condenser location	Move condenser or provide shade
	Overcharge of refrigerant	Recover, evacuate and weigh in the nameplate charge
	Hot gas valve leaks thru, unit off on refrigeration error	At the end of the freeze cycle, there should be a definite difference in temperature between the inlet and outlet of the Hot Gas Valve. If not, replace the hot gas valve
	Liquid and discharge lines are in contact with each other	Separate and insulate them
Compressor cycles on and off	Compressor overheats	Low on refrigerant, locate leak, recover refrigerant, repair leak, replace drier, evacuate and weigh in the nameplate charge.
		TXV superheat too high, check charge, if charge is OK, replace TXV
		Mechanical fault with compressor, replace compressor
		Internal relief valve opened, check for cause of high discharge pressure

Operational Characteristics: CME456R

Cycle Times:

	70°F. condenser air 70°F. indoor air, 50°F. water	90°F. condenser air 90°F. indoor air, 70°F. water
Freeze	15 to 17 minutes	17 to 19 minutes
Harvest	3 ½ minutes	2 minutes

System Pressures (PSIG) (minutes):

	70°F. condenser air 70°F. indoor air, 55°F. water	90°F. condenser air 90°F. indoor air, 70°F. water
Suction: End of Freeze	30 to 36 PSIG	34 to 38 PSIG
Suction: Peak in Harvest	75 to 85 PSIG	80 to 90 PSIG
Discharge: 5 minutes into Freeze	225 to 235 PSIG	230 to 240 PSIG

Number of Evaporators:

- 2

Refrigerant Charge

- 192 ounces of R-404A

Typical Compressor Amps,

- 7 - 13

Typical Harvest Ice Weight

- 5 - 7

Superheat

- 5 to 15 degrees

Hi Pressure Control - Automatic Reset

- Hi Pressure Cut Out - 450 PSIG
- Hi Pressure Cut In - 350 PSIG

Headmaster Valve

- Setting is 217 PSIG

CME456R

Removal and Replacement

Inlet Water Valve

1. Remove the front and left side panels.
2. Shut off the water supply.
3. Push and release the OFF button.
4. Pull the wire harness off the inlet water valve.
5. Remove screws holding the inlet water valve to the back panel.
6. Pull the valve away from the cabinet and disconnect the outlet tube.
7. Unscrew the water valve from the water inlet tubing. Hold the barbed inlet fitting and rotate the valve.
8. Reverse to reassemble.
9. Push and release the Freeze button.
10. Replace the front panel.

Water Pump

1. Disconnect the electrical power.
2. Remove the front panel.
3. Unplug water pump from its electrical connection.
4. Remove 1 plastic bolt and the reservoir cover.
5. Lift water pump up and disconnect outlet tube.
6. Pull float ball from float stem (it is a snap fit). Pull stem out.
7. Locate water level sensor mounting tabs, compress together to release sensor from bracket.
8. Remove water pump brackets from pump.
9. Reverse to replace.
10. Replace front panel.
11. Re-connect electrical power.

Purge Valve

1. Disconnect electrical power.
2. Remove front panel.
3. Unplug wire harness from purge valve coil.
4. Locate and remove the two screws securing the purge valve to the machine.

5. Pull the inlet and outlet hoses off the purge valve and remove it from the machine.

6. Reverse to reassemble. There are no internal parts available for this valve.

Purge Valve Timer

.....
The purge valve timer is sensitive to electrostatic discharge. Be certain to touch a grounded surface before touching this component. Do the same when handling the replacement part.
.....

1. Touch a grounded surface.
2. Remove front panel.
3. Disconnect electrical power.
4. Remove high voltage box cover.
5. Locate timer board at the bottom of the high voltage box.
6. Unplug all the wires to the board.
7. Compress each of the four stand-off posts to release the board from the stand-offs.
8. Remove the board from the unit.

Reverse to reassemble.

Transformer and Compressor Starting Components

Single phase compressors use a PTCR and run capacitor. All are located in a sheet metal box to the right of the AutoIQ Controller. The compressor contactor is also located in that box.

1. Disconnect electrical power.
2. Remove front panel.
3. Remove 2 screws at the front edge of the metal box, and pull the cover forward and out.
4. To check components, reconnect electrical power.

Note: The contactor coil is 24 volt.

Removal and Replacement: AutoIQ Controller

1. **Disconnect** the electrical power.
2. Remove the front panel.
3. Remove mounting screw holding controller to cabinet.
4. Touch a metal surface to discharge any static electricity.
5. Pull controller out slightly and unplug all electrical connections.

Note: Do NOT touch the back of the controller.

6. Carefully remove the new controller from its packaging. Again, do NOT touch the back of the controller.
7. Plug all electrical connectors into the new controller.
8. Re-attach the controller to the cabinet.
9. Switch on the electrical power. All Lights should lite up.
10. Push and release the Freeze button.
11. Replace the front panel.

Electric Eyes (Ice Sensors)

These must be replaced as a set.

1. Remove front panel.
2. Push and release the Off button.
3. Remove evaporator cover.
4. Remove cascading shield.
5. Locate the front and back ice sensors. Each has a rectangular tab that was holding the cascading shield. Pull on that tab until each sensor has been removed.
6. Unplug sensors from controller connections 3 and 4.
7. Remove sensors from machine. Note: Some cable ties may have to be cut and side panels removed.
8. Reverse to reassemble. Be sure that the color codes of the connecting wires match.

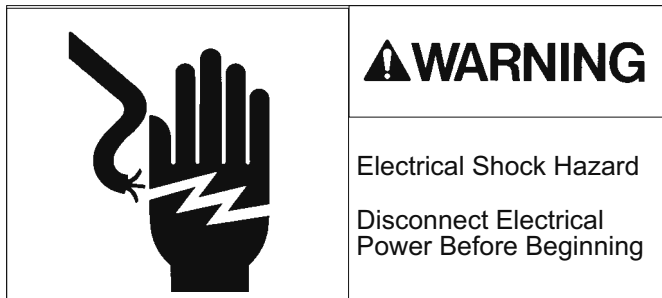

1. Remove front panel.
2. Push and hold the OFF button. Release it when the machine stops.
3. Trace wire harness from water level sensor to the Controller (#2). Unplug the harness from the controller.
4. Lift the pump and mounting plate up enough to remove the float from the stem.
5. Remove two screws holding the sensor to the pump bracket and lift the sensor up and out of the machine.
6. Reverse to reassemble.

Discharge Line Temperature Sensor

1. Remove front panel, push and release the Off button.
2. Remove top and left side panels.
3. Locate discharge line sensor. It is attached to the discharge line of the compressor, 6" from the compressor discharge port.
4. Un-snap the clip holding the sensor to the discharge line.
5. Trace the sensor wires back to the controller, they are plugged into #5 with the water temperature sensor, and must be replaced with it.
6. Reverse to replace, be sure that the discharge line sensor is 6" up from the compressor discharge port. The discharge line sensor is marked with yellow tape.

Note: Route wires so they do NOT contact the discharge line.

Water Temperature Sensor

Note: This sensor is replaced as a set with the Discharge Temperature Sensor.

1. Remove left side and front panel.
2. Push and release Off button.
3. Remove 1 plastic bolt and the reservoir cover.
4. Locate water temperature sensor (inserted into pump discharge hose).
5. Pull out to remove.
6. Trace back to AutoIQ Controller, unplug from #5.
7. Remove the Discharge Line temperature sensor.
8. Reverse to reassemble.

.....
Note: Do not push sensor tip in too far. There should be about an 1/8" gap between the tip and the inner wall of the water discharge hose.
.....

Refrigerant

1. This ice machine uses R-404A or HP62 as a refrigerant. It has several unique characteristics.

A. It is a near-azeotrope, and must be liquid charged.

B. It must use polyol ester refrigerant oil, and that oil is very water absorbent. The system must not be open for more than 15 minutes.

C. An electronic leak detector capable of locating HFC-134a type refrigerant must be used to locate refrigerant leaks.

D. A special HFC type liquid line dryer must be used.

E. When brazing, a dry nitrogen purge is required.

F. When evacuating, use of an electronic micron gage is recommend. Evacuate to 300 microns.

Recovering the Refrigerant

Because of the check valves, liquid refrigerant must be recovered thru the liquid line valve and the low side access valve.

1. Low Side: Remove the stem cap and insert a 3/16" allen wrench. Check that the valve is closed.

Liquid Line: Remove the stem cap. Use a refrigeration wrench and check that the valve stem is fully UP or OUT. If recovering, remove the schrod core before opening the valve.

2. Remove the port caps and attach refrigerant manifold hoses.

3. Open the valves. Note: Open liquid line valve half way to access both sides of the liquid line.

4. Recover the refrigerant using the normal techniques for the recovery machine used.

Evacuation

Evacuate to **300** microns

Charging

1. Use an electronic scale to measure the charge.

2. Place a drum or cylinder of R-404A on the scale in position to dispense liquid refrigerant.

3. A refrigeration manifold is assumed to be attached to the service access valves. Attach the charging hose to the cylinder of R-404A. Open the cylinder's valve and purge the hose to the manifold.

4. Be sure that the low side access valve is closed.

5. Open the discharge side manifold valve and weigh in the name plate charge. After the charge is weighed in re-check the scale.

Liquid Charging

6. If all of the refrigerant charge has not been weighed into the discharge side, it must be carefully added thru the low side. Close the discharge service access valve.

7. With a sight glass or charge faster in the hose to the low side port, start the ice machine.

8. Open the low side service access valve.

9. Crack open the low side *manifold* valve and watch the scale and sight glass. Open and close the low side manifold valve to flow liquid into the manifold but flash off to vapor before it enters the suction side of the refrigeration system.

10. After the scale = the correct charge, shut off the valve on the refrigerant cylinder.

11. With the ice machine running and the discharge access valve closed, open both manifold valves to allow the refrigerant in the hoses to enter the system.

12. Shut the suction service access valve.

13. Remove the refrigeration manifold gages.

14. Replace and tighten all caps.

CME456R

Before Calling for Service

Check the following:

1. Has the water supply to the ice machine or building been shut off? If yes, the ice machine will automatically restart within 25 minutes after water begins to flow to it.
2. Has power been shut off to the ice machine? If yes, the ice machine will automatically restart when power is restored.
3. Did the remote condenser's fan stop turning? If yes, the ice machine may need to be manually reset.
4. Does the bin control have ice on it? If so, remove the ice and the machine should start in a few minutes.

To Manually Reset the machine.

1. Remove the front panel.
2. Locate the AutoIQ Controller. If a red diagnostic light is glowing, note which one and its blink rate. Then push and release the off button.
3. Push and release the Freeze button.
4. The machine should begin to operate. If there is a lack of water it will soon shut off again.
5. Return the front panel to its normal position.

If the machine shuts down again, call for service.

To Shut the Machine Off:

1. Remove the front panel.
2. Locate the AutoIQ Controller.
3. Push and hold the Off button for 3 seconds or until the machine stops.

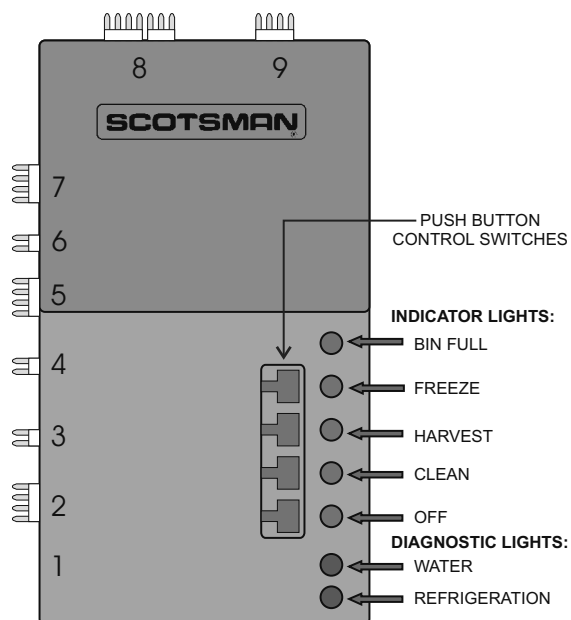

SERVICE BULLETIN

Subject: New Ice Sensors in CME1356, CME1656 and CME2006. New Ice Sensors, new Water Level Sensors and new Controllers in CME306 and CME456.

Ice Sensors: Scotsman has begun production of ice machines equipped with a new style of ice sensor. The new sensor is interchangeable with the prior sensors, which are still in use on other Scotsman modular cubers.

Controllers: Scotsman has also added the new blue controller (see PS-3-2002) to models CME306 and CME456.

Water Level Sensor: A new water level sensor is also being used on CME306 and CME456.

Service parts for the ice sensors and water level sensor have not changed.

Ice machines built prior to this change are not affected.

The new sensors' use will be phased in by model throughout 2002.

Additional information is on the back of this bulletin.

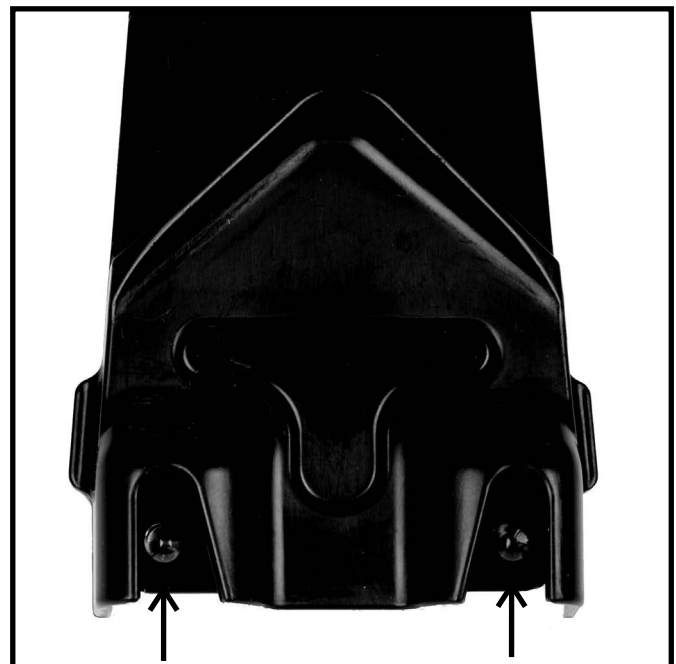

Photo-Eyes in New Ice Sensor

Sensor Holder



Push to Release Photo-Eye Module

The new ice sensor's have a photo-eye module that can be separated from the holder.

Once separated, the lenses of the photo-eyes can easily be cleaned with a soft cloth or cotton swab. Ice machine cleaner may be used if needed.

Like the other style of sensor, the photo-eye part can be placed in the reservoir when the ice machine is being cleaned with ice machine cleaner.

When re-assembling, be sure that the wire is not sticking out past the edges of the sensor holder.



Photo-Eye Module Separated from Holder



Route Wire Under Clip, Push Module Into Place