

# MCM1062W SERVICE PARTS

This parts list contains the parts for the MCM1062W. The model number of the machine is located on the ice machine in two places: on the back panel, and behind the front panel below the control box.

Check the model number to be certain of obtaining the correct parts.

## TABLE OF CONTENTS

Cabinet . . . . .	Page 2
Refrigeration System . . . . .	Page 3
Water System . . . . .	Page 4
Control Box . . . . .	Page 5
MDB560 Ice Storage Bin . . . . .	Page 6
Wiring Diagrams . . . . .	Page 7

# MCM1062W SERVICE PARTS

## CABINET

ITEM NUMBER	PART NUMBER	DESCRIPTION	ITEM NUMBER	PART NUMBER	DESCRIPTION
1	A32159-002	Top Panel, SS	12	A31461-001	Tube bracket
2	02-2887-02	Right Liner	13	A34908-021	Transducer
3	A35453-002	Right Side Panel, SS	14	02-0836-00	Catch
4	A32470-001	Brace	15	A34038-002	Service Panel
5	A32469-001	Upper cabinet brace	16	03-1404-12	Screw
6	03-1531-01	Screw	17	A32435-002	Left Side Panel
7	A34862-002	Front Panel	18	no number	Base Assembly
	15-0411-00	Strike for front panel	19	A32454-001	Retainer
	03-1406-04	Nut for strike	20	A34826-002	Back Panel
8	A32549-001	Flange retainer	21	A32452-002	Right Back Panel
9	A32587-001	Upper Evap. Brace	22	02-2888-02	Back Liner
10	A32467-001	Lower Evap. Brace	23	A32464-001	Curtain Stand Off
11	02-2885-02	Left liner			

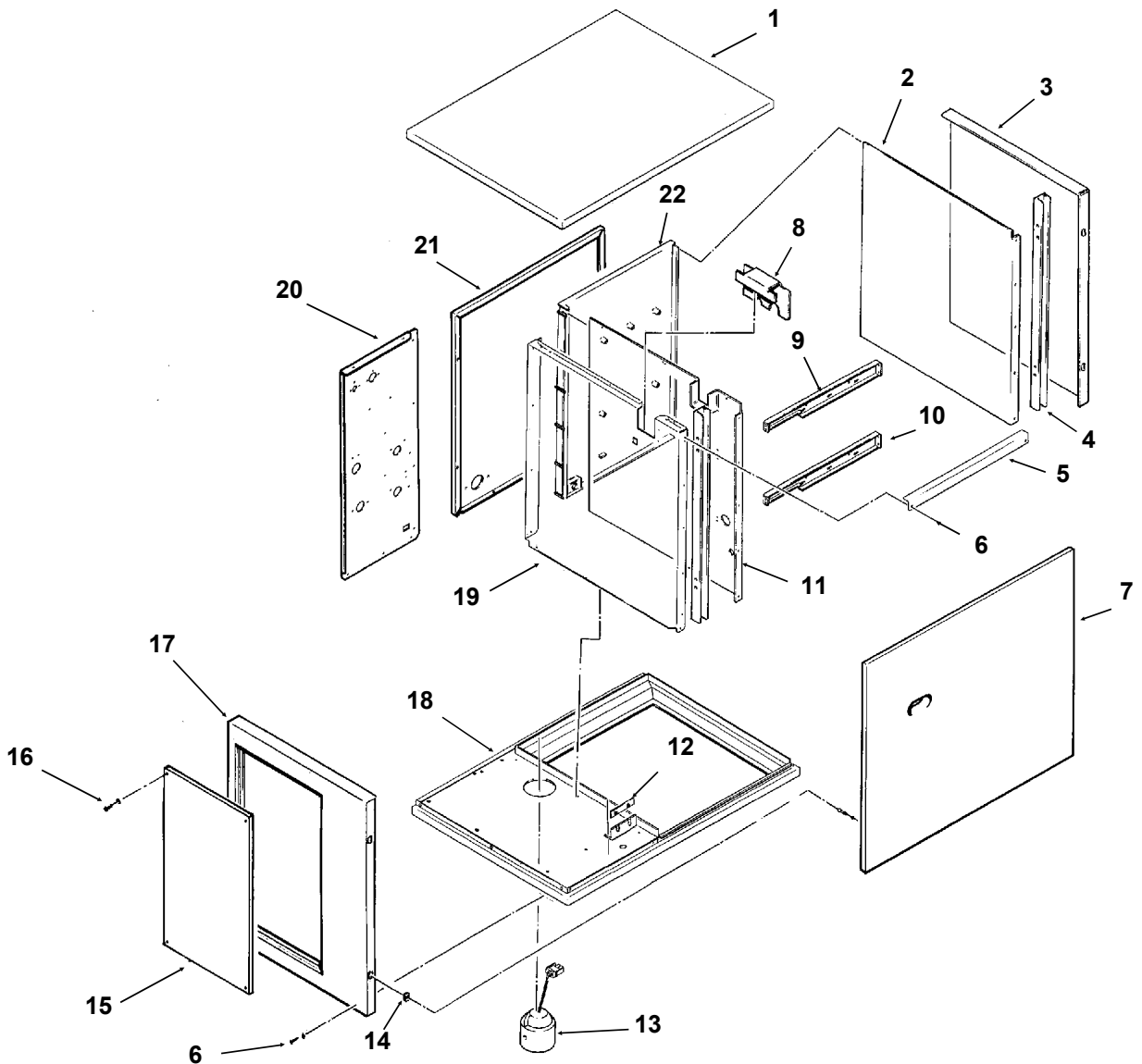

# MCM1062W SERVICE PARTS

## REFRIGERATION SYSTEM

ITEM NUMBER	PART NUMBER	DESCRIPTION	ITEM NUMBER	PART NUMBER	DESCRIPTION
1	16-0876-01	Evap. inlet assembly	8	02-2628-02	Receiver
2	A30296-020	Evaporator	9	11-0424-01	Water regulating valve
3	11-0463-21	Hi pressure control switch	10	A31828-003	Drain adaptor
4	16-0560-00	Valve core	11	18-8200-25	Water cooled condenser
	16-0563-00	Cap	12	12-2320-22	Hot gas valve
5	16-0801-22	Accumulator		02-3231-02	Hot gas valve filter
6	02-3319-02	Filter dryer	13	12-2300-02	Hi temp cut out
7	18-8862-22	Compressor 203-230/60/3	14	16-0816-22	Thermo expansion valve
	18-2200-27	Sleeve		02-2920-01	Insulation for TXV (half)
	18-2200-28	Grommet	15	16-0792-02	Distributor
	03-1405-20	Screw			

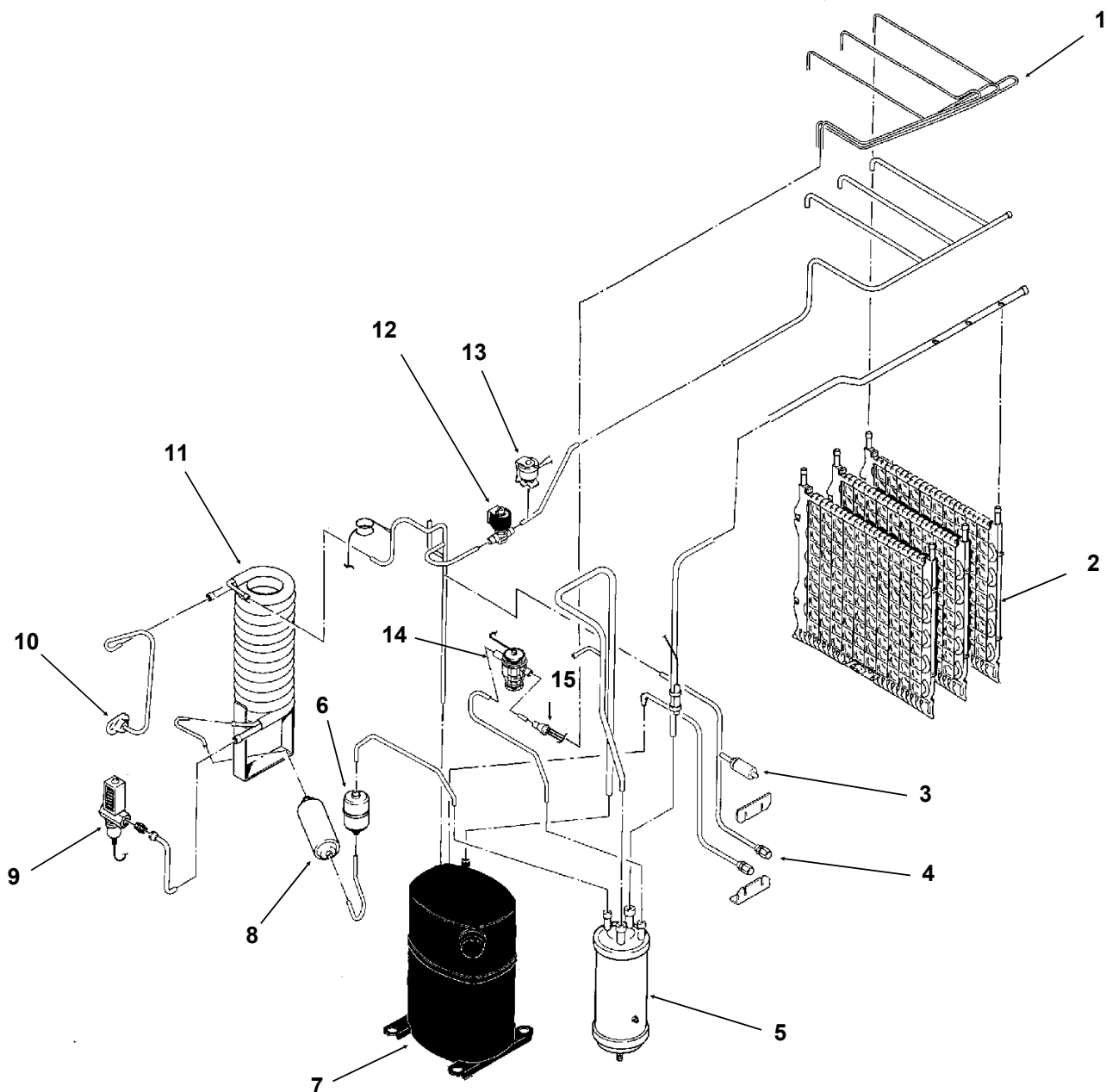

# MCM1062W SERVICE PARTS

## WATER SYSTEM

ITEM NUMBER	PART NUMBER	DESCRIPTION	ITEM NUMBER	PART NUMBER	DESCRIPTION
1	02-2527-01	Water Distributor Tube	8	A30296-020	Evaporator
2	02-2521-01	Water Manifold, long	9	02-2890-03	Evaporator Cover
3	13-0617-48	O-Ring	10	A35861-001	Reservoir
4	A29703-001	Water Manifold, short	11	12-1646-11	Inlet Water Valve
5	02-2895-01	Water Restrictor	12	13-0674-01	Hose (8" needed)
6	13-0674-07	Tube (need 30")	13	12-2419-62	Water Pump
7	02-3094-01	Hose clamp	14	A32462-001	Housing, pump
			15	A32551-001	Bracket, pump
			16	03-0727-00	Thumb screw
			17	03-1406-05	Nut for top of pump
			18	03-1407-03	Washer for top of pump
			19	13-0674-07	Drain hose (16.5" needed)
			20	02-3094-01	Hose clamp
			21	A32282-003	Drain
			22	03-1394-01	Pal nut
			23	16-0791-01	Coupling (half union)
			24	16-0794-01	Adaptor
			25	16-0631-02	Connector, female
			26	16-0162-00	Strainer
			27	A32474-001	Inlet Tube
			28	13-0796-01	Reservoir Drain Cap

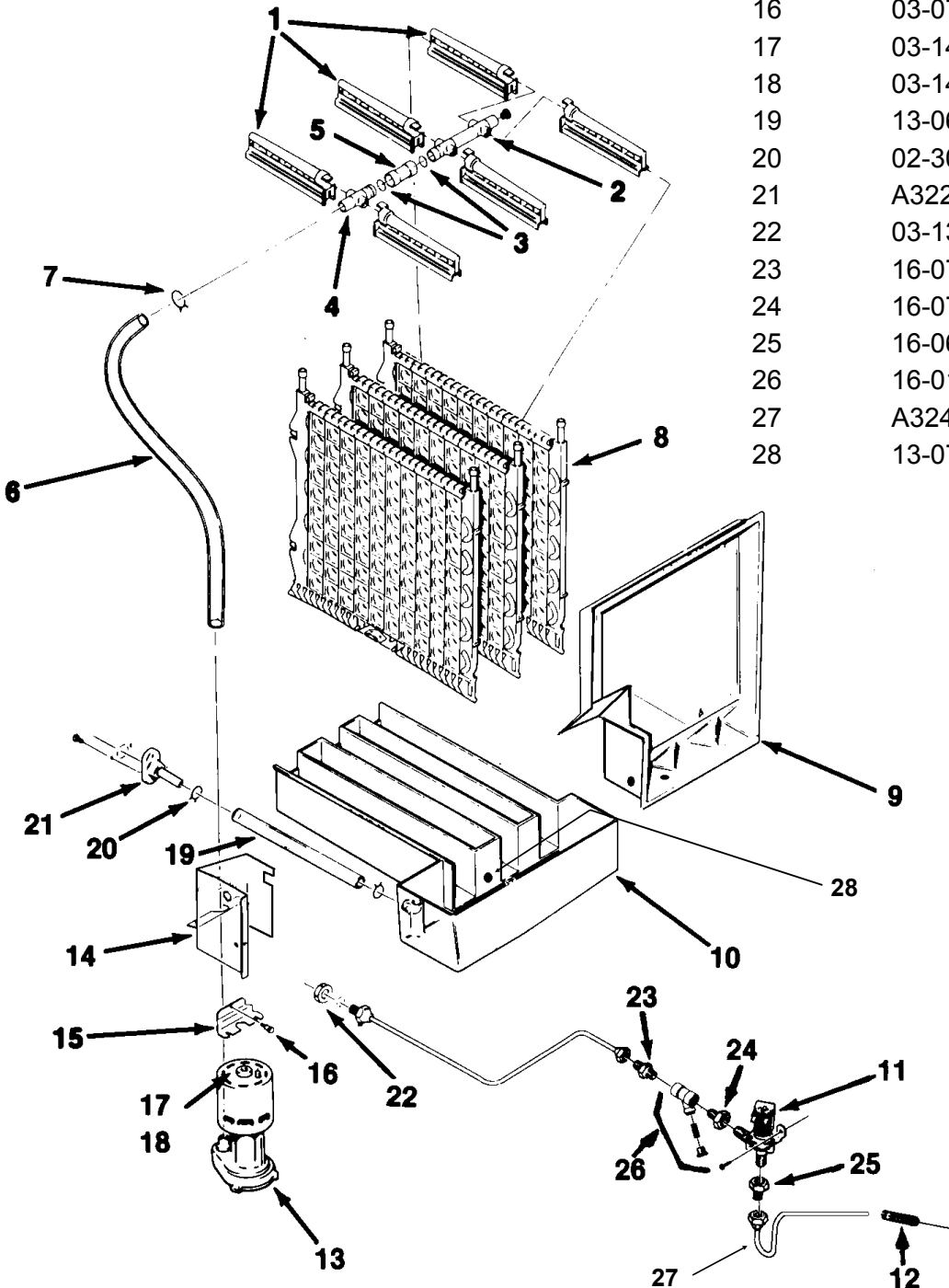

# MCM1062W SERVICE PARTS CONTROL BOX

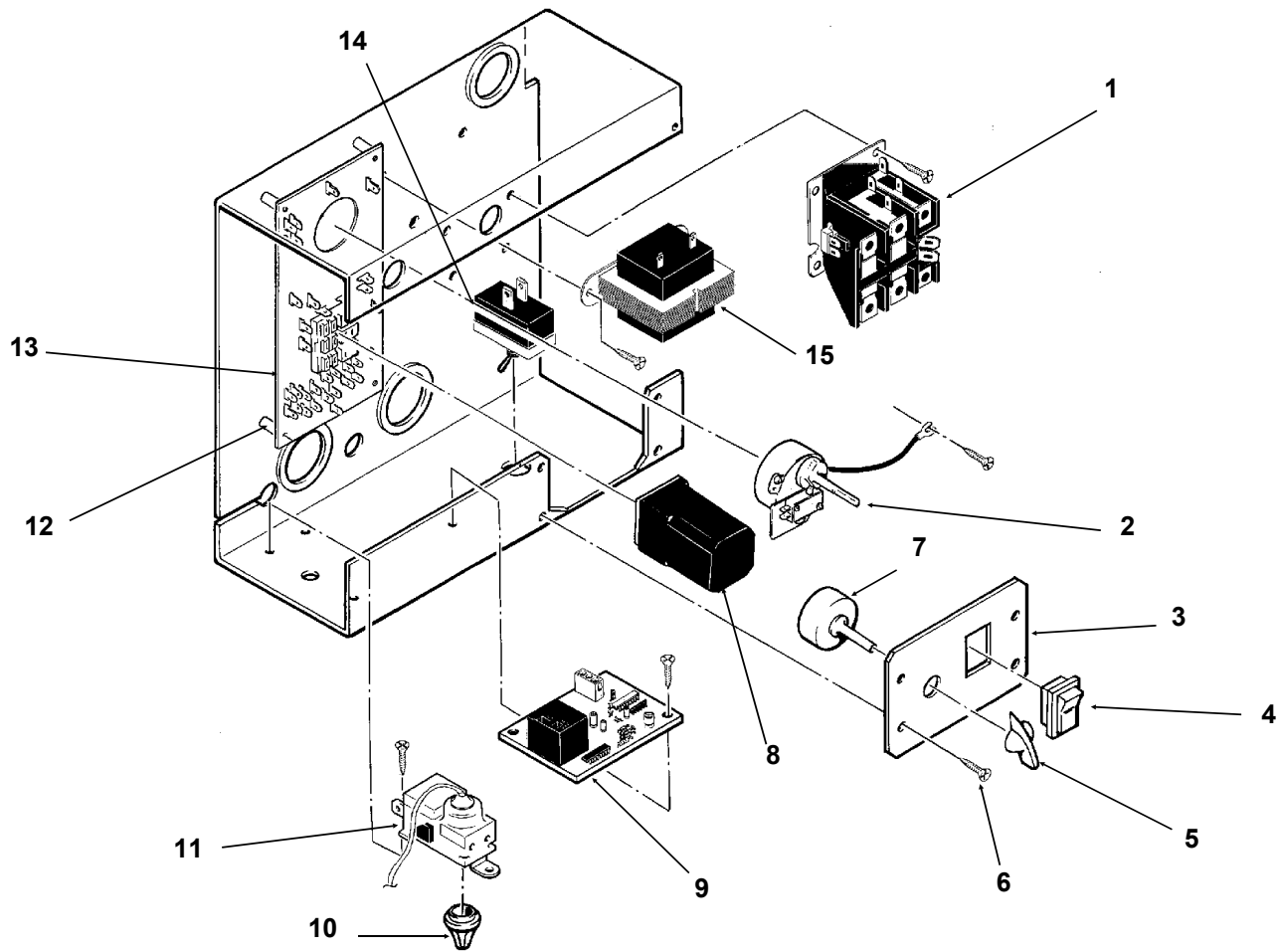

ITEM NUMBER	PART NUMBER	DESCRIPTION
1	12-0739-02	Contactors 3 phase
2	12-2317-22	Timer and microswitch
3	A34880-001	Cover plate
4	12-2375-01	ON/OFF/WASH switch
5	02-3126-01	Knob
6	03-1638-03	Screw
7	12-2400-01	Selector switch, connects to item 9
8	12-1879-03	Relay
9	12-2376-21	Bin level control board
10	no number	Knob for cube size control, part of item 11
11	11-0436-21	Cube size control, includes knob
12	02-2242-02	Stand off
13	12-1912-01	Circuit board
14	12-0426-01	Compressor on off switch
15	12-2285-22	Transformer
Not Shown		
16	A34845-001	Control Box Cover

# MCM1062W SERVICE PARTS

## MDB560 ICE STORAGE BIN SERVICE PARTS

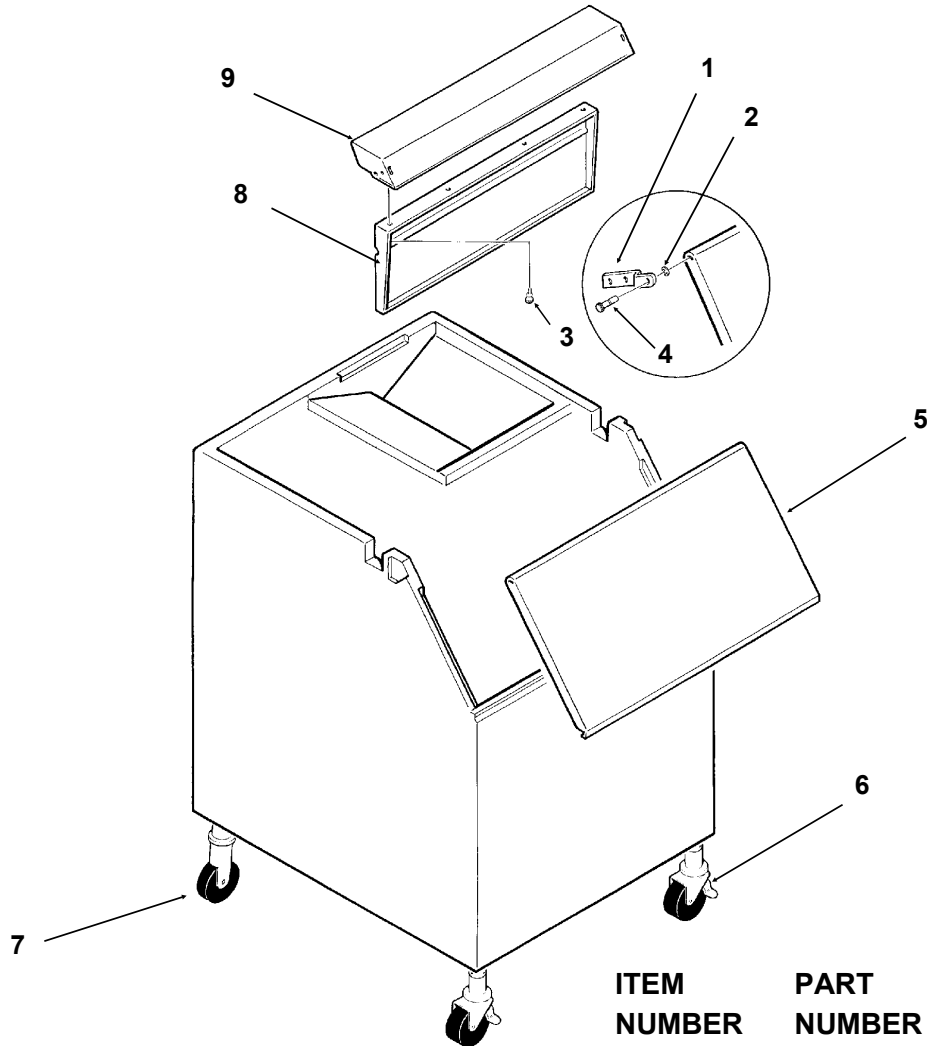

ITEM NUMBER	PART NUMBER	DESCRIPTION
1	02-3139-01	Hinge Bracket
2	03-1539-09	E Ring
3	03-0727-11	Thumb Screw
4	02-2806-01	Shoulder screw
5	A35368-001	Bin Door
6	02-3111-01	Front Caster (swivel)
7	02-3110-01	Back Caster
8	A34932-001	Baffle
9	A35021-020	Canopy Assy

**Not Shown:**

10	19-0503-04	Bin Top Gasket (req. 104")
11	02-0540-01	Scoop
12	A34930-001	Scoop Holder
13	A34931-001	Bumper
14	02-2380-02	Spacer for hinges

# MCM1062W SERVICE PARTS

## MDB550 Ice Storage Bin

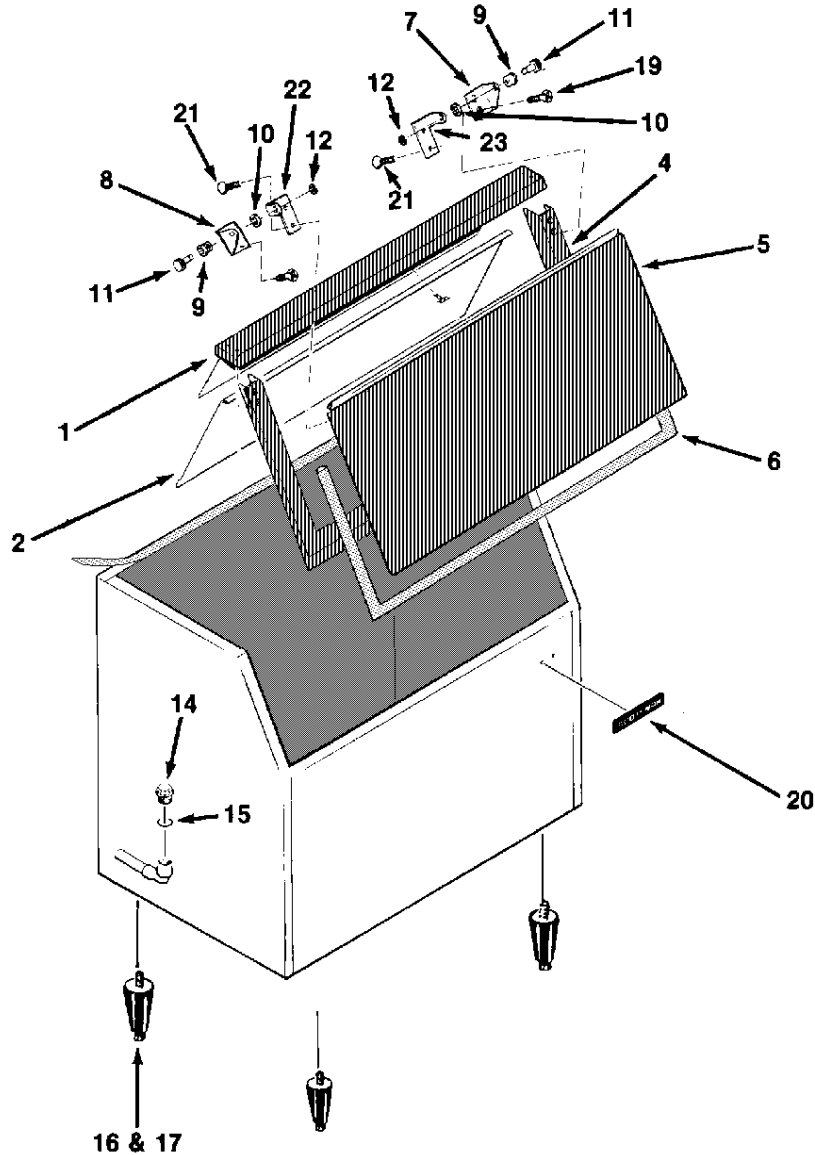

MDB550

ITEM NUMBER	PART NUMBER	DESCRIPTION	ITEM NUMBER	PART NUMBER	DESCRIPTION
1	A33921-001	Canopy	14	02-2809-01	Drain Top
2	a32580-001	Baffle	15	13-0617-11	O-Ring
3	19-0503-04	Gasket	16	no number	Leg, not used.
4	A33922-020	Door Frame	17	02-3111-01	Front caster, swivel
5	A33938-020	Door		02-3110-01	Back caster
6	13-0595-00	Door Gasket, 6' req.	18	03-1404-06	Screw
7	A32396-002	Hinge Right	19	03-1360-02	Screw
8	A32396-001	Hinge Left	20	no number	not used
9	02-2380-02	Hinge Bushing	21	03-1418-41	Screw
10	02-2380-02	Hinge Spacer	22	A32546-001	Door hinge left
11	02-2806-01	Shoulder Screw	23	A32546-002	Door hinge right
12	03-1539-09	E-Clip	24	03-1423-07	Speed nut for baffle
13	03-0727-06	Thumb Screw			

# MCM1062W SERVICE PARTS

## WIRING DIAGRAM 208-230/60/3

NOTE: DASHED LINES INDICATE FIELD WIRING WHICH MUST BE INSTALLED IN ACCORDANCE WITH THE NATIONAL ELECTRICAL CODE AND ALL STATE AND LOCAL CODES.

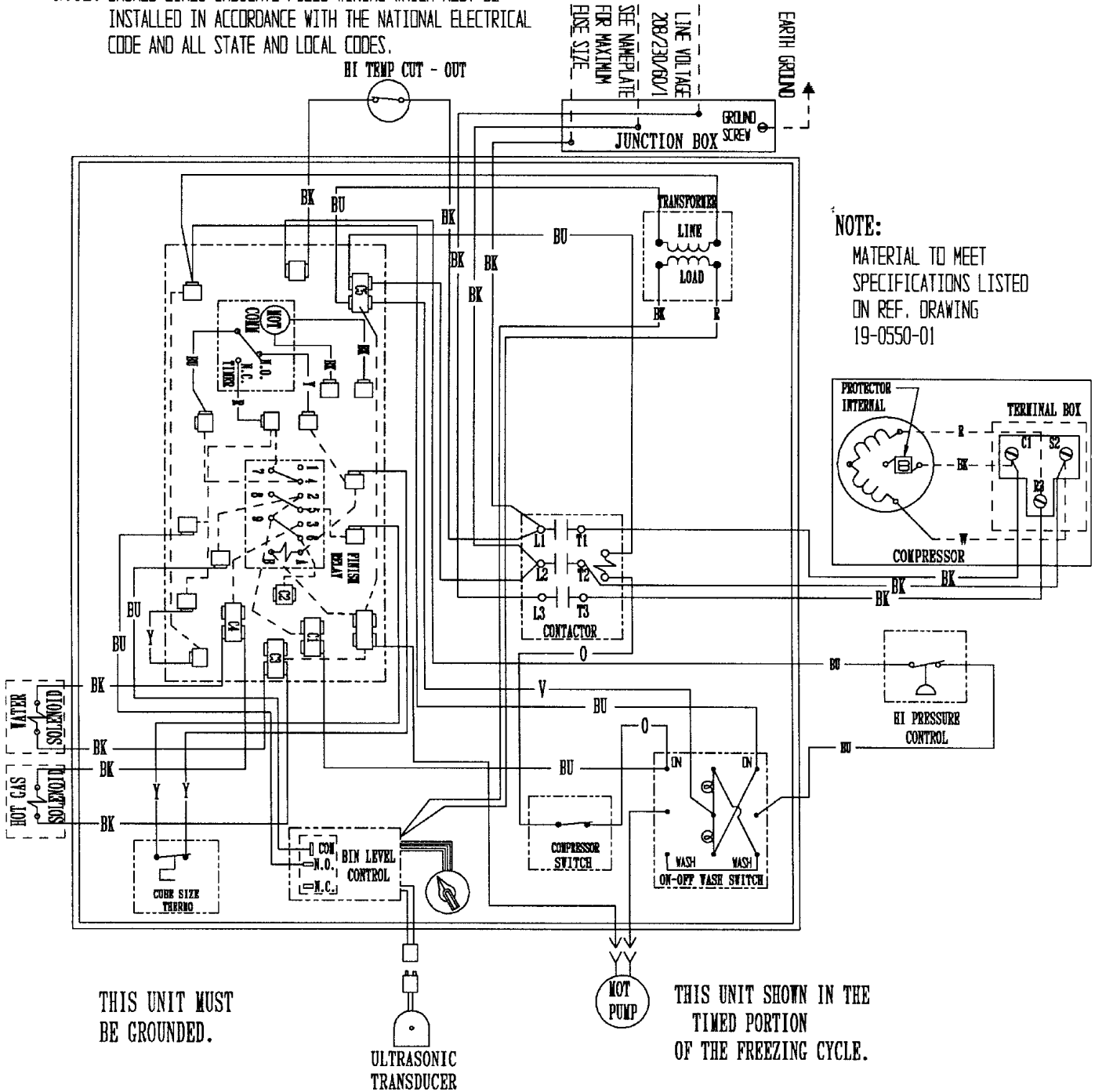

NOTE:  
MATERIAL TO MEET  
SPECIFICATIONS LISTED  
ON REF. DRAWING  
19-0550-01

THIS UNIT MUST  
BE GROUNDED.

THIS UNIT SHOWN IN THE  
TIMED PORTION  
OF THE FREEZING CYCLE.



# MCM1062W SERVICE PARTS

## SCHEMATIC DIAGRAM 208-230/60/3

### CAUTION:

MORE THAN ONE DISCONNECT MEANS MAY BE REQUIRED TO DISCONNECT ALL POWER TO THIS UNIT.

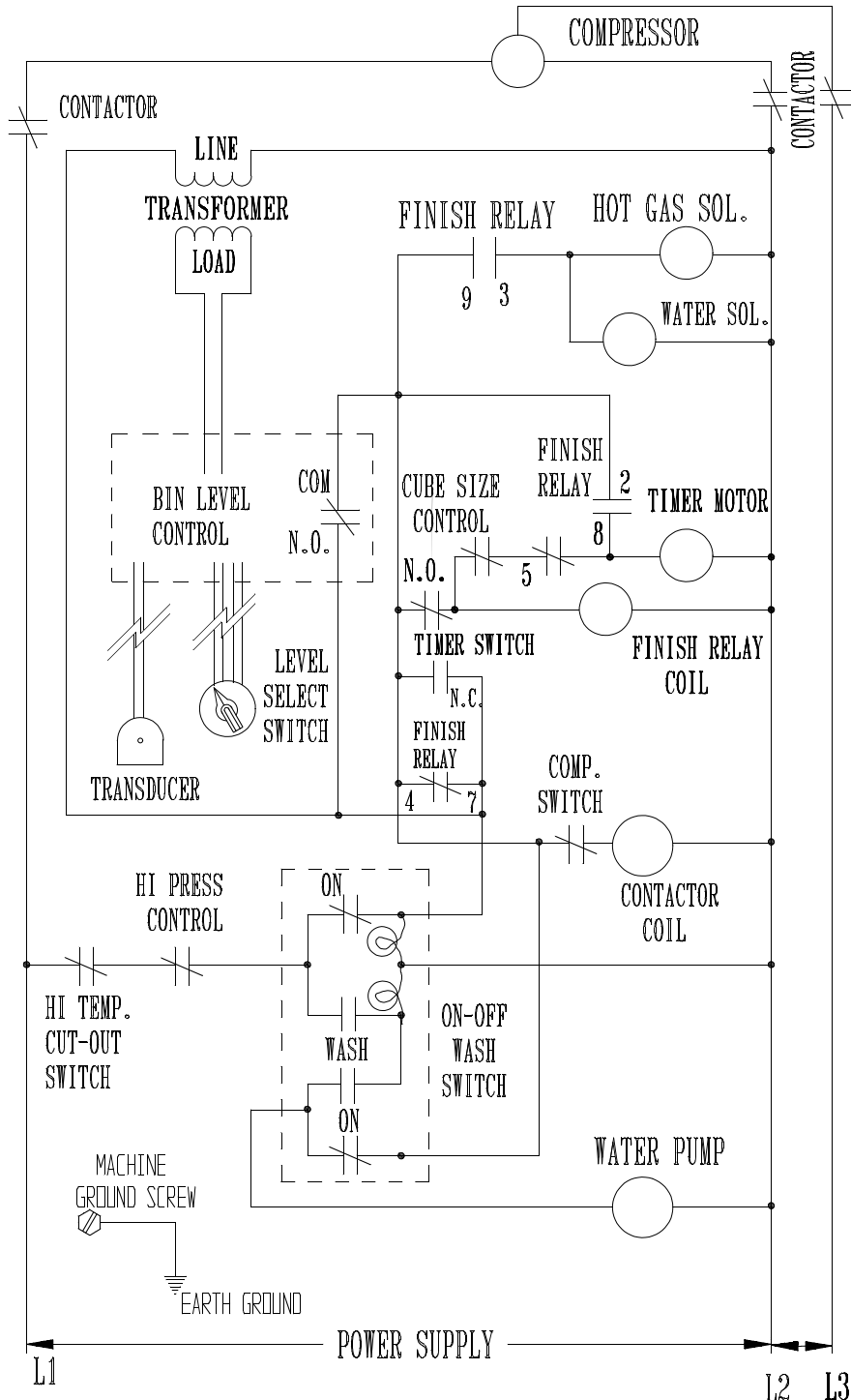

USE COPPER CONDUCTORS ONLY

April, 1993

Page 9