

MCM860R SERVICE PARTS

This parts list contains the parts for the MCM860R. The model number of the machine is located on the ice machine in two places: on the back panel, and behind the front panel below the control box.

Check the model number to be certain of obtaining the correct parts.

TABLE OF CONTENTS

Cabinet	Page 2
Refrigeration System	Page 3
Water System	Page 4
Control Box	Page 5
Remote Condenser	Page 6
MDB560 Ice Storage Bin	Page 7
Wiring Diagrams	Page 8

MCM860R SERVICE PARTS CABINET

ITEM NUMBER	PART NUMBER	DESCRIPTION	ITEM NUMBER	PART NUMBER	DESCRIPTION
1	A32159-002	Top Panel, SS	12	A31461-001	Tube bracket
2	02-2887-02	Right Liner	13	A34908-021	Transducer
3	A32456-002	Right Side Panel, SS	14	02-0836-00	Catch
4	A32470-001	Brace	15	A34038-002	Service Panel
5	A32469-001	Upper cabinet brace	16	03-1404-12	Screw
6	03-1531-01	Screw	17	A32435-002	Left Side Panel
7	A34862-002	Front Panel	18	no number	Base Assembly
	15-0411-00	Strike for front panel	19	A32454-001	Retainer
	03-1406-04	Nut for strike	20	A34826-002	Back Panel
8	A32549-001	Flange retainer	21	A32452-002	Right Back Panel
9	A32587-001	Upper Evap. Brace	22	02-2888-02	Back Liner
10	A32467-001	Lower Evap. Brace			
11	02-2885-02	Left liner			

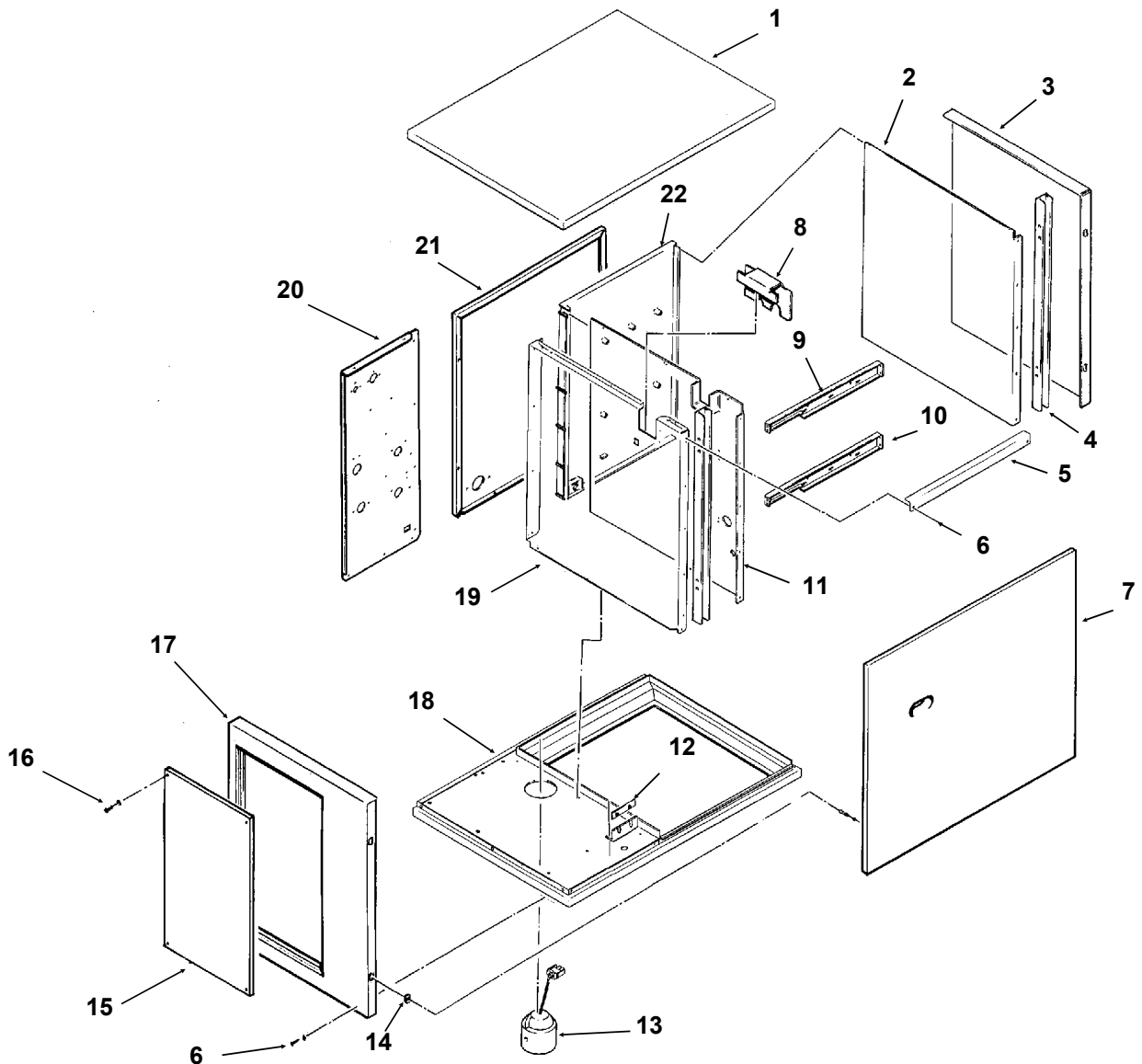

MCM860R SERVICE PARTS

REFRIGERATION SYSTEM

ITEM NUMBER	PART NUMBER	DESCRIPTION	ITEM NUMBER	PART NUMBER	DESCRIPTION
1	A34848-001	Evap. inlet assembly	8	12-2274-01	Liquid line valve
2	A30296-020	Evaporator	9	02-3319-02	Filter dryer
3	11-0446-24	Hi pressure control switch	10	16-0761-01	Receiver
4	16-0560-00	Valve core	11	16-0850-03	3/8" male coupling
	16-0563-00	Cap	12	16-0850-01	1/2" male coupling
5	16-1157-22	Accumulator	13	11-0422-22	Head press. control valve
6	11-0450-21	Pump down control switch	14	12-2320-22	Hot gas valve
7	18-5900-03	Compressor 203-230/60/3	15	12-2300-02	Hi temp cut out
	12-1868-03	Crankcase heater	16	16-0758-24	Thermo expansion valve
	18-2200-27	Sleeve		02-2920-01	Insulation for TXV (half)
	18-2200-28	Grommet			
	03-1405-20	Screw			

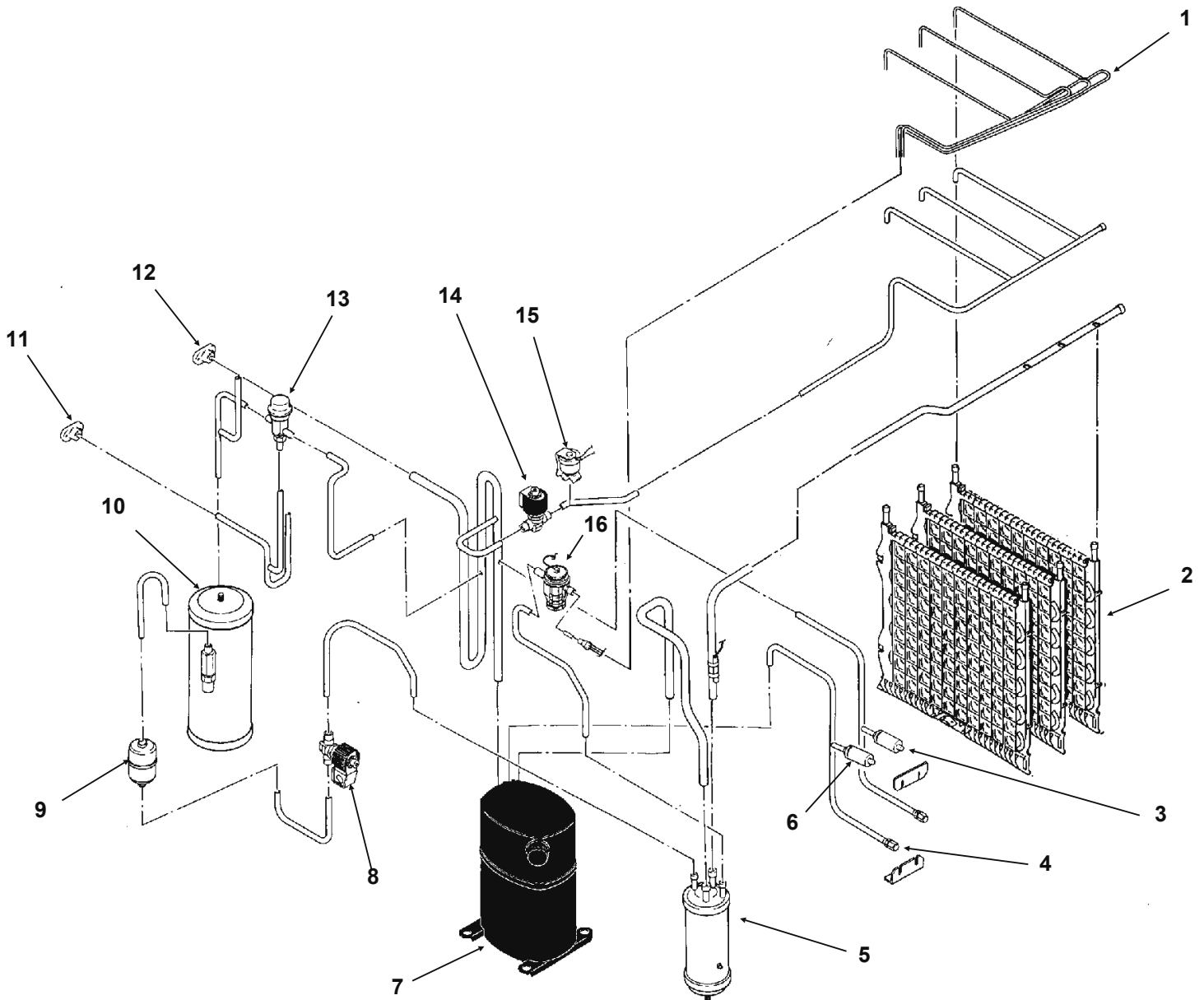

MCM860R SERVICE PARTS

WATER SYSTEM

ITEM NUMBER	PART NUMBER	DESCRIPTION	ITEM NUMBER	PART NUMBER	DESCRIPTION
1	02-2527-01	Water Distributor Tube	8	A30296-020	Evaporator
2	02-2521-01	Water Manifold, long	9	02-2890-02	Evaporator Cover
3	13-0617-48	O-Ring	10	02-2889-02	Reservoir
4	A29703-001	Water Manifold, short	11	12-1646-10	Inlet Water Valve
5	02-2895-01	Water Restrictor	12	13-0674-01	Hose (3" needed)
6	13-0674-07	Tube (need 30")	13	12-2419-62	Water Pump
7	02-3094-01	Hose clamp	14	A32462-001	Housing, pump
			15	A32551-001	Bracket, pump
			16	03-0727-00	Thumb screw
			17	03-1406-05	Nut for top of pump
			18	03-1407-03	Washer for top of pump
			19	13-0674-07	Drain hose (16.5" needed)
			20	02-3094-01	Hose clamp
			21	A32202-003	Drain
			22	03-1394-01	Pal nut
			23	16-0791-01	Coupling (half union)
			24	16-0794-01	Adaptor
			25	16-0631-02	Connector, female
			26	16-0162-00	Strainer
			27	A32474-001	Inlet Tube
			28	13-0796-01	Reservoir Drain Cap

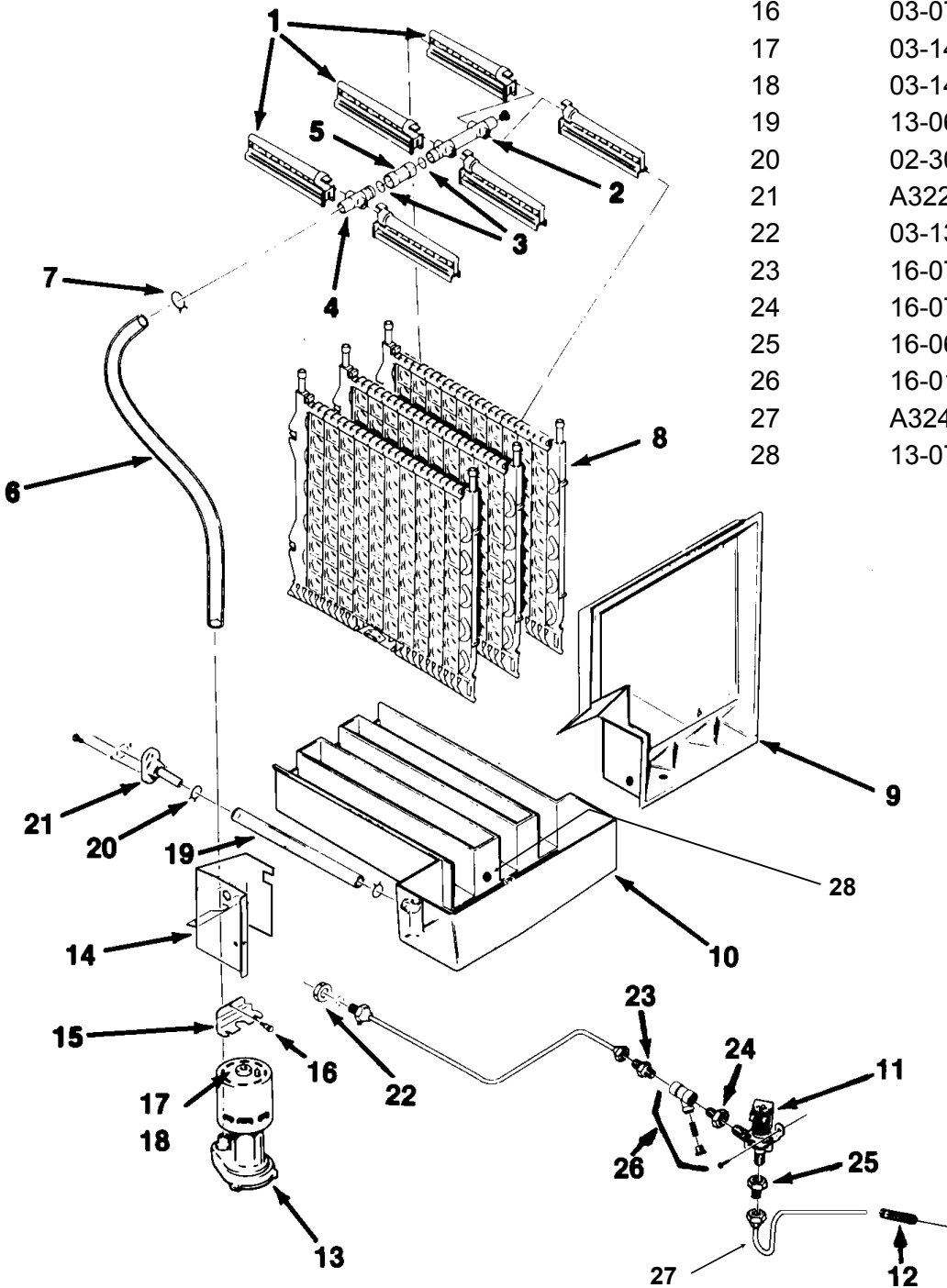

MCM860R SERVICE PARTS CONTROL BOX

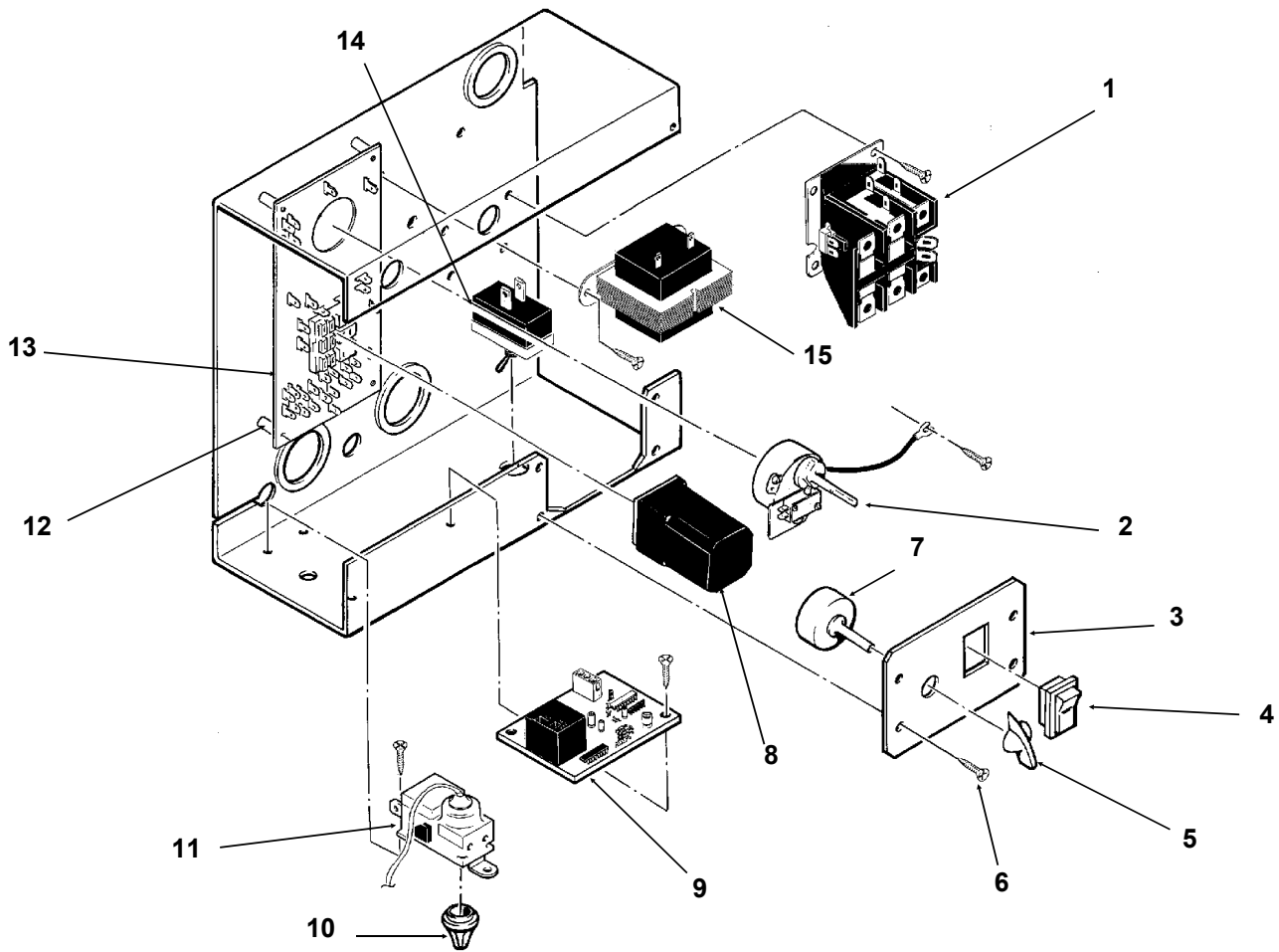

ITEM NUMBER	PART NUMBER	DESCRIPTION
1	12-0739-02	Contactors 3 phase
2	12-2317-22	Timer and microswitch
3	A34880-001	Cover plate
4	12-2375-01	ON/OFF/WASH switch
5	02-3126-01	Knob
6	03-1638-03	Screw
7	12-2400-01	Selector switch, connects to item 9
8	12-1879-03	Relay
9	12-2376-21	Bin level control board
10	no number	Knob for cube size control, part of item 11
11	11-0437-21	Cube size control, includes knob
12	02-2242-02	Stand off
13	12-1912-01	Circuit board
14	12-0426-01	Compressor on off switch
15	12-2285-22	Transformer

Not Shown:

16	A34845-001	Control Box Cover
17	17-1961-01	Label for control box cover

MCM860R SERVICE PARTS

SCOTSMAN REMOTE CONDENSER

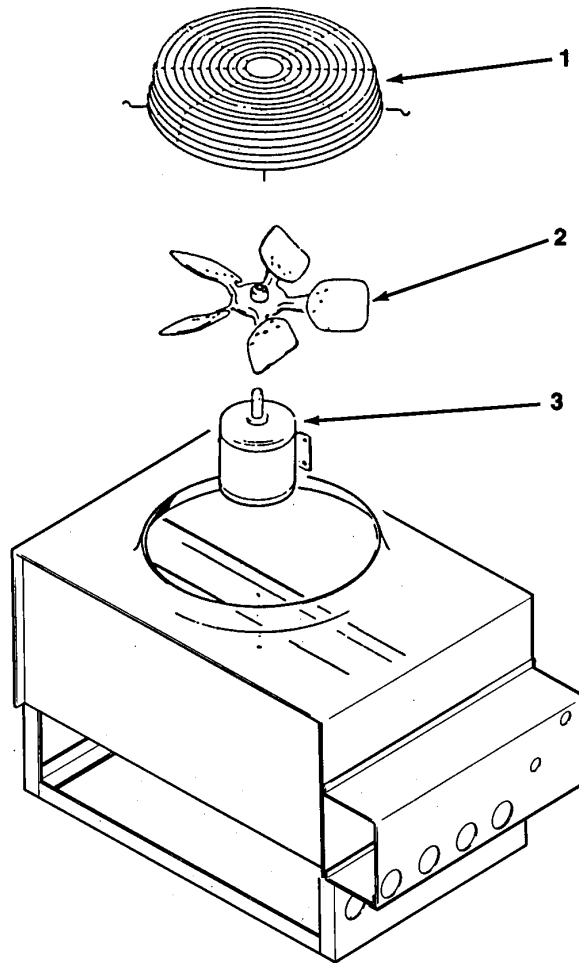

RC1052

ITEM NUMBER	PART NUMBER	DESCRIPTION
1	02-2628-01	Fan Guard
2	18-6304-01	Fan Blade
3	18-5301-01	Fan Motor

For Precharged Line set:

4	16-1057-01	Female coupling (3/8")
5	16-1057-02	Female coupling (1/2")

MCM860R SERVICE PARTS

MDB560 ICE STORAGE BIN SERVICE PARTS

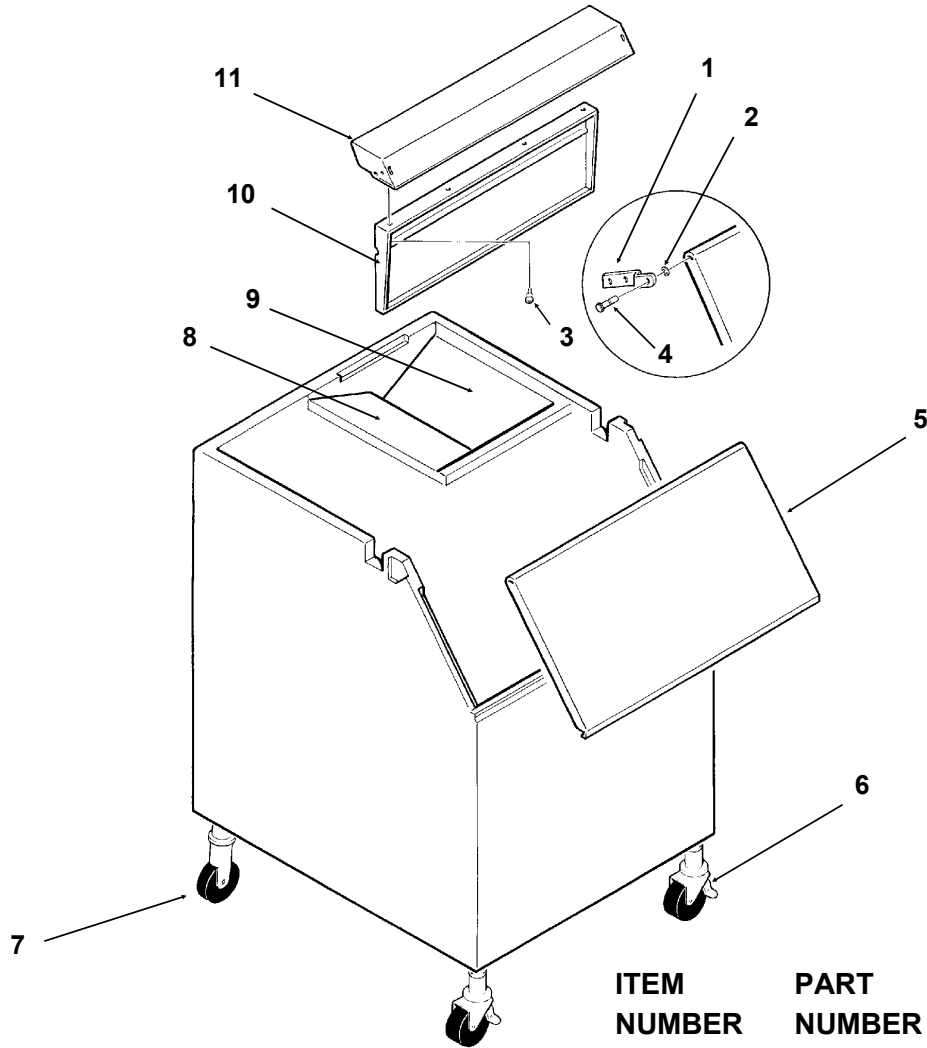

ITEM NUMBER	PART NUMBER	DESCRIPTION
1	02-3139-01	Hinge Bracket
2	03-1539-09	E Ring
3	03-0727-11	Thumb Screw
4	02-3139-01	Hinge Bracket
5	A34895-001	Bin Door
6	02-3111-01	Front Caster (swivel)
7	02-3110-01	Back Caster
8	A34926-001	Water Collector
9	A34927-001	Water Collector Tray
10	A34932-001	Baffle
11	A35021-020	Canopy Assy

Not Shown:

12	19-0503-04	Bin Top Gasket (req. 104")
13	02-0540-01	Scoop
14	A34930-001	Scoop Holder
15	A34931-001	Bumper

MCM860R SERVICE PARTS

WIRING DIAGRAM 208-230/60/3

NOTE: DASHED LINES INDICATE FIELD WIRING WHICH MUST BE INSTALLED IN ACCORDANCE WITH THE NATIONAL ELECTRICAL CODE AND ALL STATE AND LOCAL CODES.

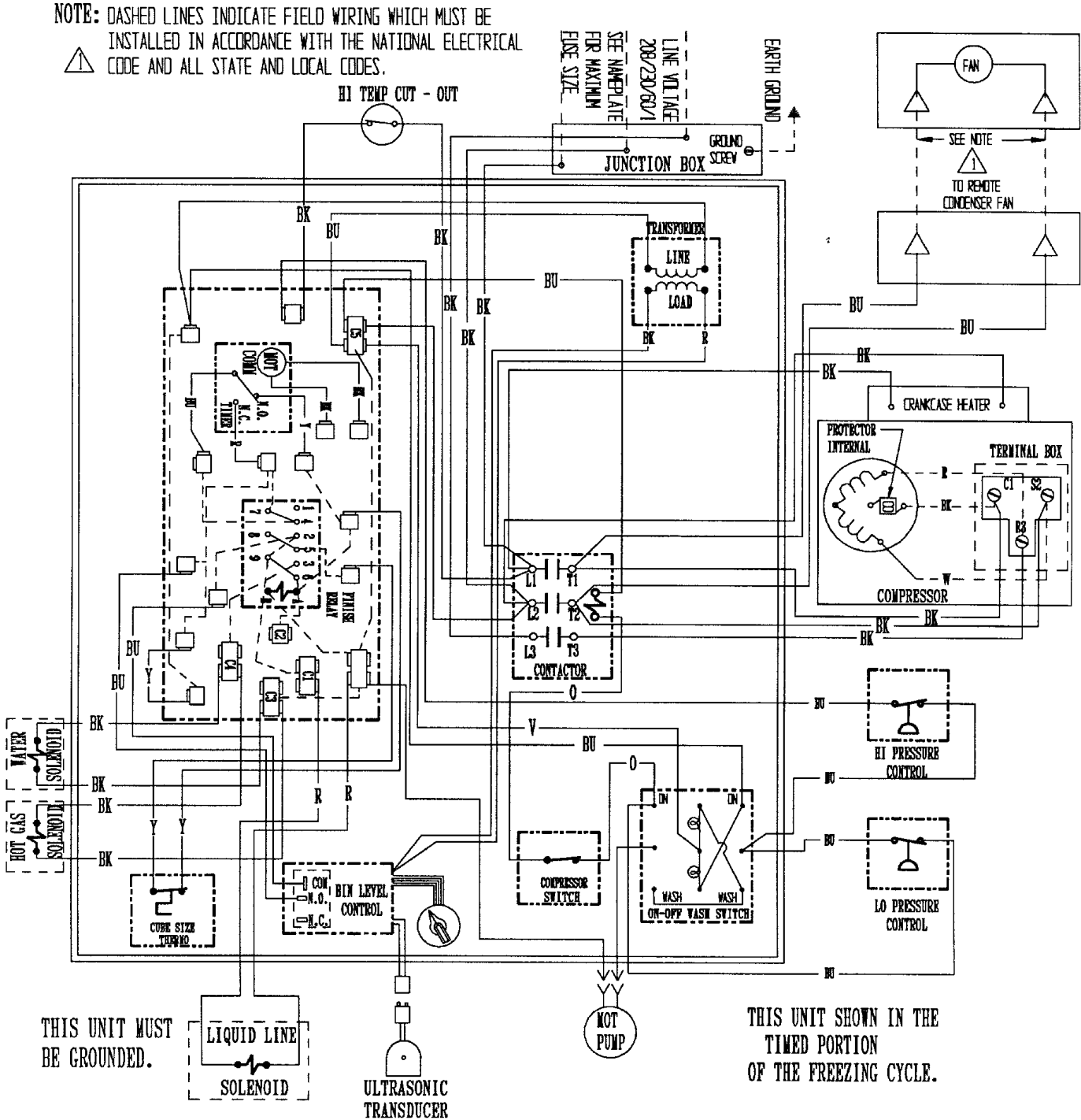

THIS UNIT MUST BE GROUNDED.

THIS UNIT SHOWN IN THE TIMED PORTION OF THE FREEZING CYCLE.

MCM860R SERVICE PARTS

SCHEMATIC DIAGRAM 208-230/60/3

CAUTION:

MORE THAN ONE DISCONNECT MEANS MAY BE REQUIRED TO DISCONNECT ALL POWER TO THIS UNIT.

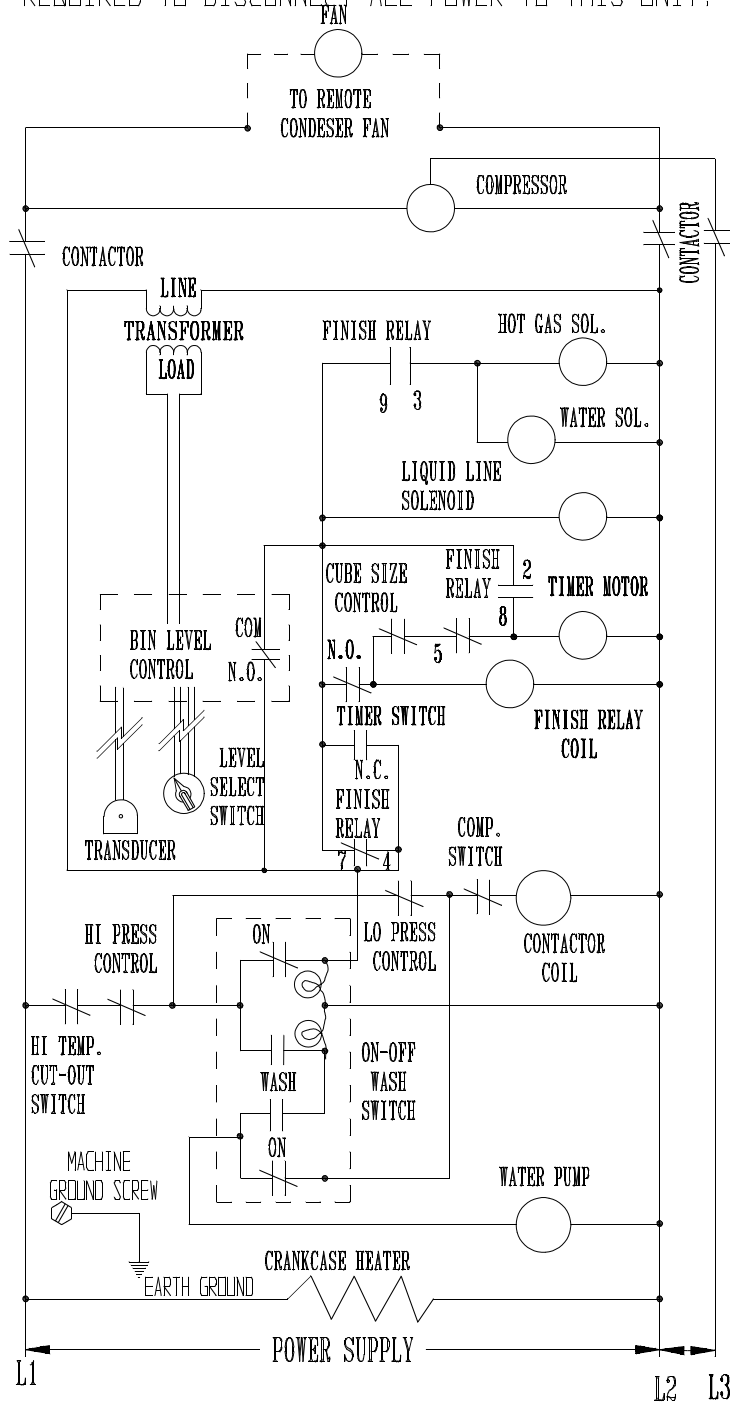

USE COPPER CONDUCTORS ONLY

NOTE:

MATERIAL TO MEET SPECIFICATIONS LISTED
ON REF. DRAWING 19-0550-01