

NM1250R SERVICE PARTS

This section contains the parts illustrations and parts lists for the NM1250R.

When ordering parts of assemblies, to avoid costly delays and errors in shipment, give the part number, the complete description as shown in the list and the quantity of each part or assembly.

Table of Contents

Panels.....	page2
Refrigeration	page3
Evaporator	page 4
Control Box.....	page 5
Gearmotor.....	page 6
Reservoir and drains	page 7
Remote condenser	page 8
Wiring diagrams.....	page 9

NM1250R SERVICE PARTS

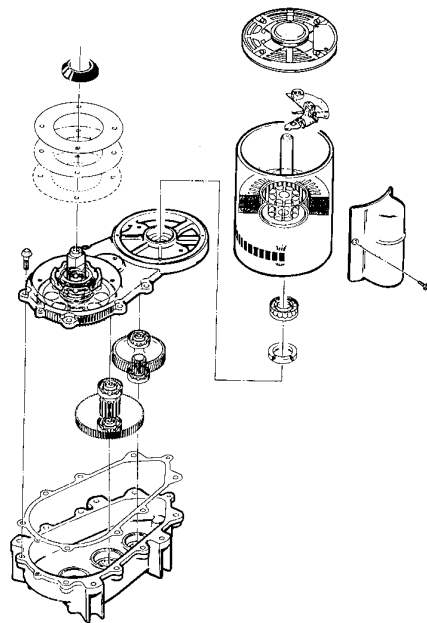
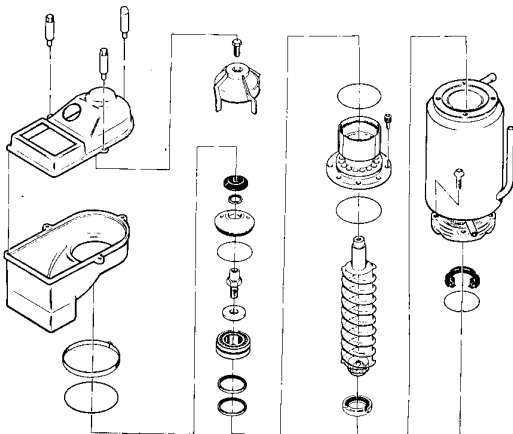
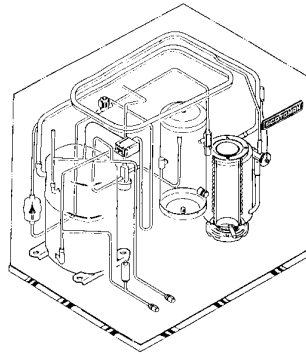
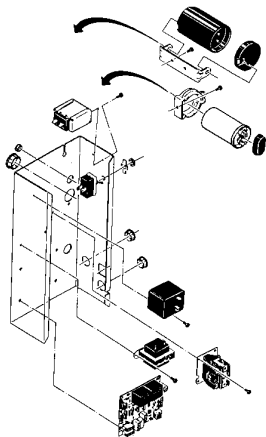
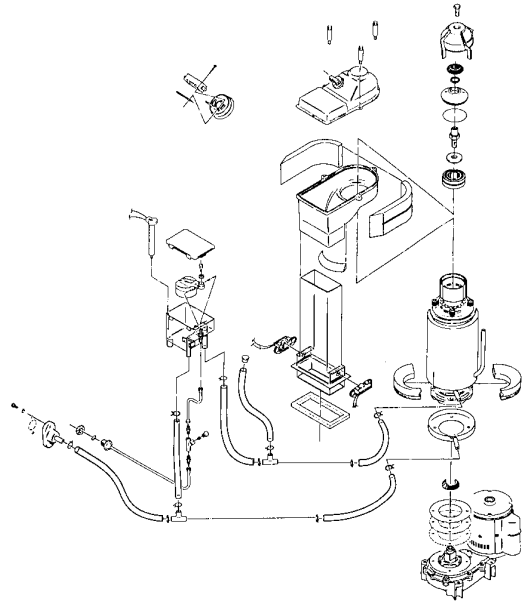
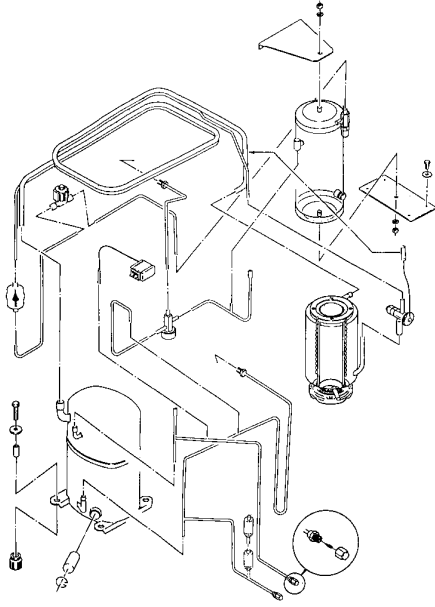

NM1250R SERVICE PARTS PANELS

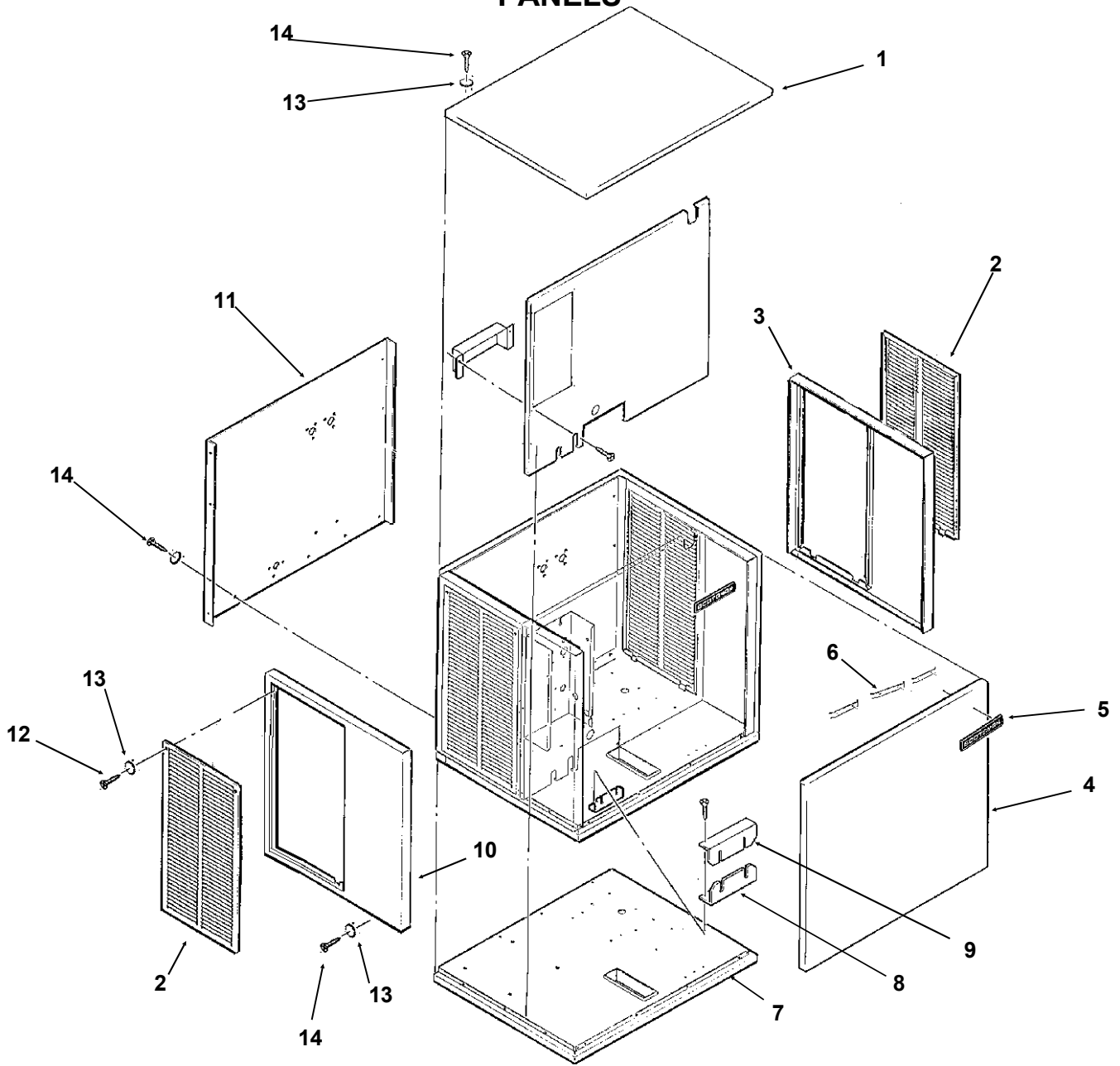

ITEM NUMBER	PART NUMBER	DESCRIPTION	ITEM NUMBER	PART NUMBER	DESCRIPTION
1.	A32159-001	Top Panel Painted	7.	A32542-001	Base Assembly
	A32159-002	Top Panel Stainless	8.	A31462-001	Tube Bracket
2.	A32161-001	Service Panel Paint	9.	A31461-001	Tube Bracket
	A32161-002	Service Panel S.S.	10.	A32163-001	Left End Panel Pt.
3.	A32162-001	Right End Panel Pt.		A32163-002	Left End Panel S.S.
	A32162-002	Right End Panel S.S.	11.	A32201-001	Back Panel
4.	A32160-001	Front Panel Painted	12.	03-1404-12	Screw
	A32160-002	Front Panel S.S.	13.	03-1417-03	Washer
5.	15-0711-01	Emblem	14.	03-1531-01	Screw
6.	03-0271-00	Clip For Emblem (3)			

NM1250R SERVICE PARTS REFRIGERATION

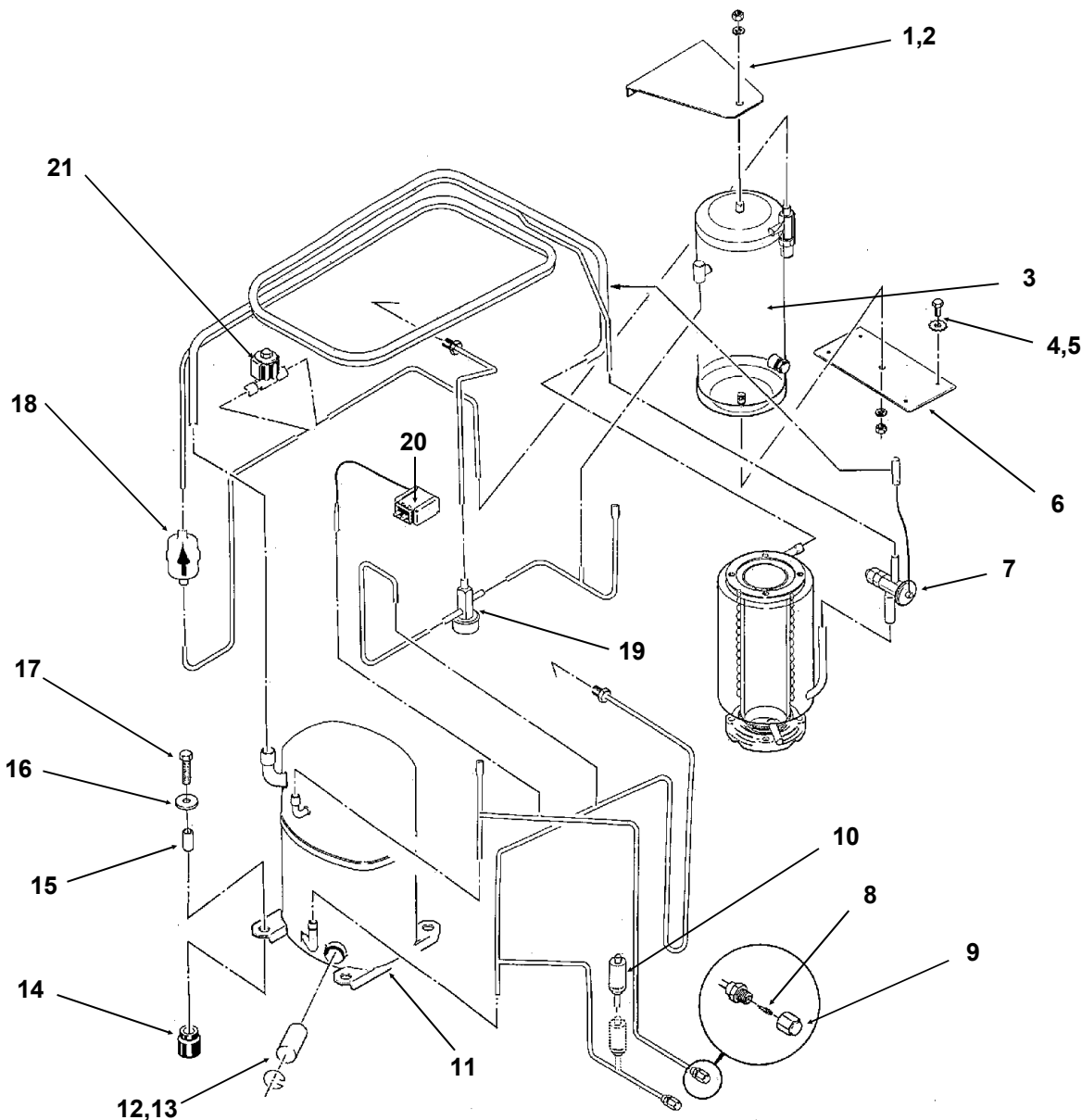

ITEM NUMBER	PART NUMBER	DESCRIPTION	ITEM NUMBER	PART NUMBER	DESCRIPTION
1.	03-1406-13	Nut	11.	18-5900-03	Compressor 208-230/60/3 (includes item 12)
2.	03-1410-06	Washer	12.	12-2308-01	Heater
3.	16-0761-01	Receiver	13.	12-2309-01	clip
4.	03-1645-01	Screw	14.	18-6800-01	Grommet
5.	03-1417-09	Washer	15.	18-2300-26	Sleeve
6.	A31801-002	Bracket	16.	03-1407-07	Washer
7.	16-0780-21	Thermo. Exp. Valve	17.	03-1405-20	Bolt
8.	16-0560-00	Valve Core	18.	02-3319-02	Drier
9.	16-0563-00	Valve Cap	19.	11-0422-22	Lo Temp Valve
10.	11-0446-21	High Press. Switch	20.	11-0420-23	Pump Down Switch
11.	18-5900-04	Compressor 208-230/60/1 (includes item 12)	21.	12-2257-01	Liquid Line Valve

NM1250R SERVICE PARTS EVAPORATOR

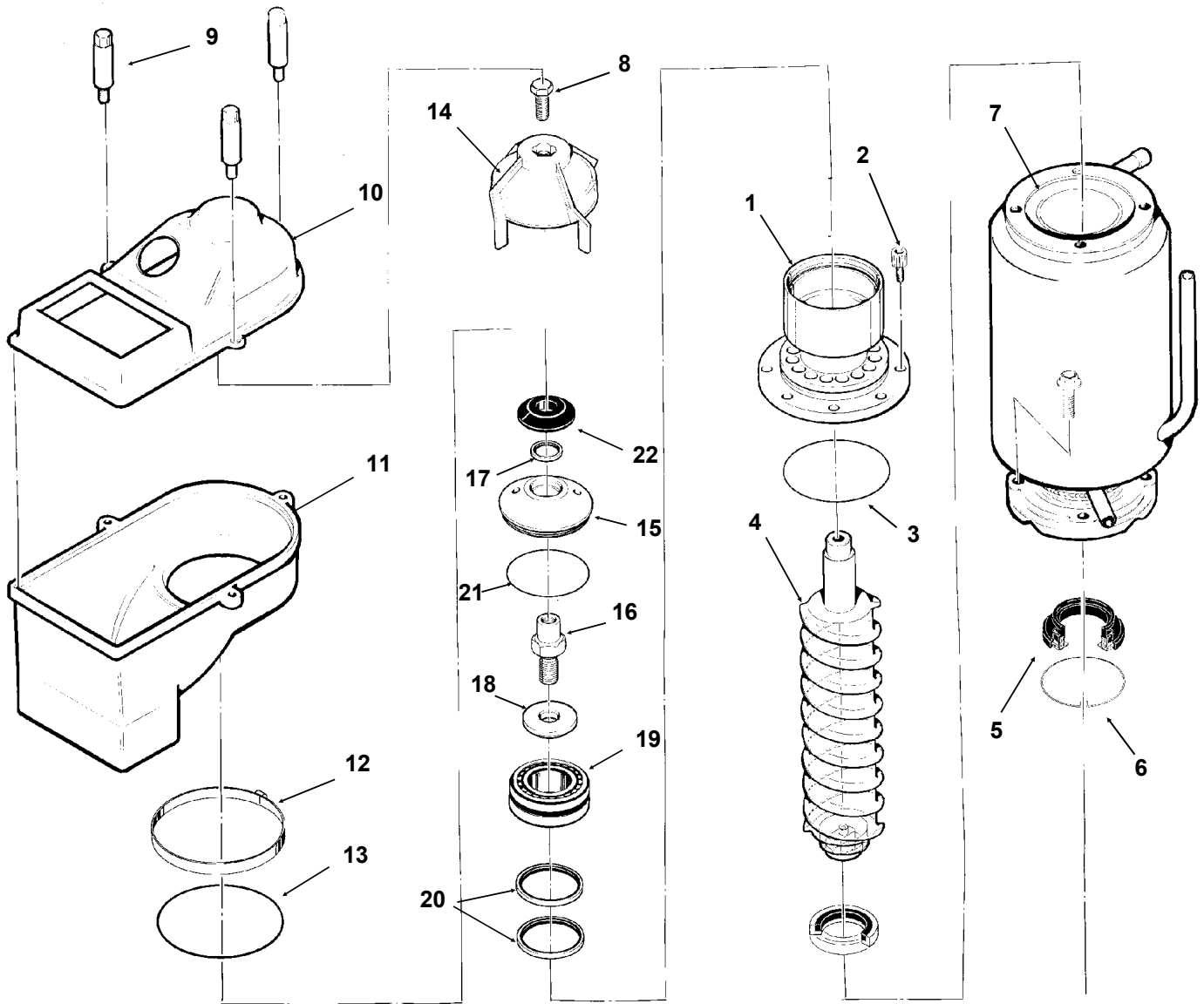

ITEM NUMBER	PART NUMBER	DESCRIPTION	ITEM NUMBER	PART NUMBER	DESCRIPTION
1.	A32900-020	Breaker	10.	02-2930-01	Ice Chute Cover
2.	03-1544-08	Soc. head Screw	11.	02-2926-01	Ice Chute Body
3.	13-0617-45	O-ring	12.	A32905-001	Clamp
4.	A38071-022	Auger	13.	13-0617-52	O-ring
5.	02-0929-23	Water Seal	14.	02-3001-01	Ice Sweep
6.	A32777-001	Ring, Water Seal	15.	02-3128-20	Breaker Cover
7.	A32890-020	Evaporator	16.	08-0660-01	Auger Stud
8.	03-1405-52	Hex Cap Screw	17.	02-2978-01	Lip Seal
9.	02-2933-01	Hex stud	18.	part of item 16	Thrust Washer
	A34969-001	Bail clamp, use began Jan. 91	19.	A34559-020	Bearing
			20.	02-2977-01	Lip Seal
			21.	13-0617-54	O-Ring
			22.	13-0871-01	Water Shed

Note: Evaporator is not available with internal parts. The auger and water seal must be ordered separately.

NM1250R SERVICE PARTS CONTROL BOX

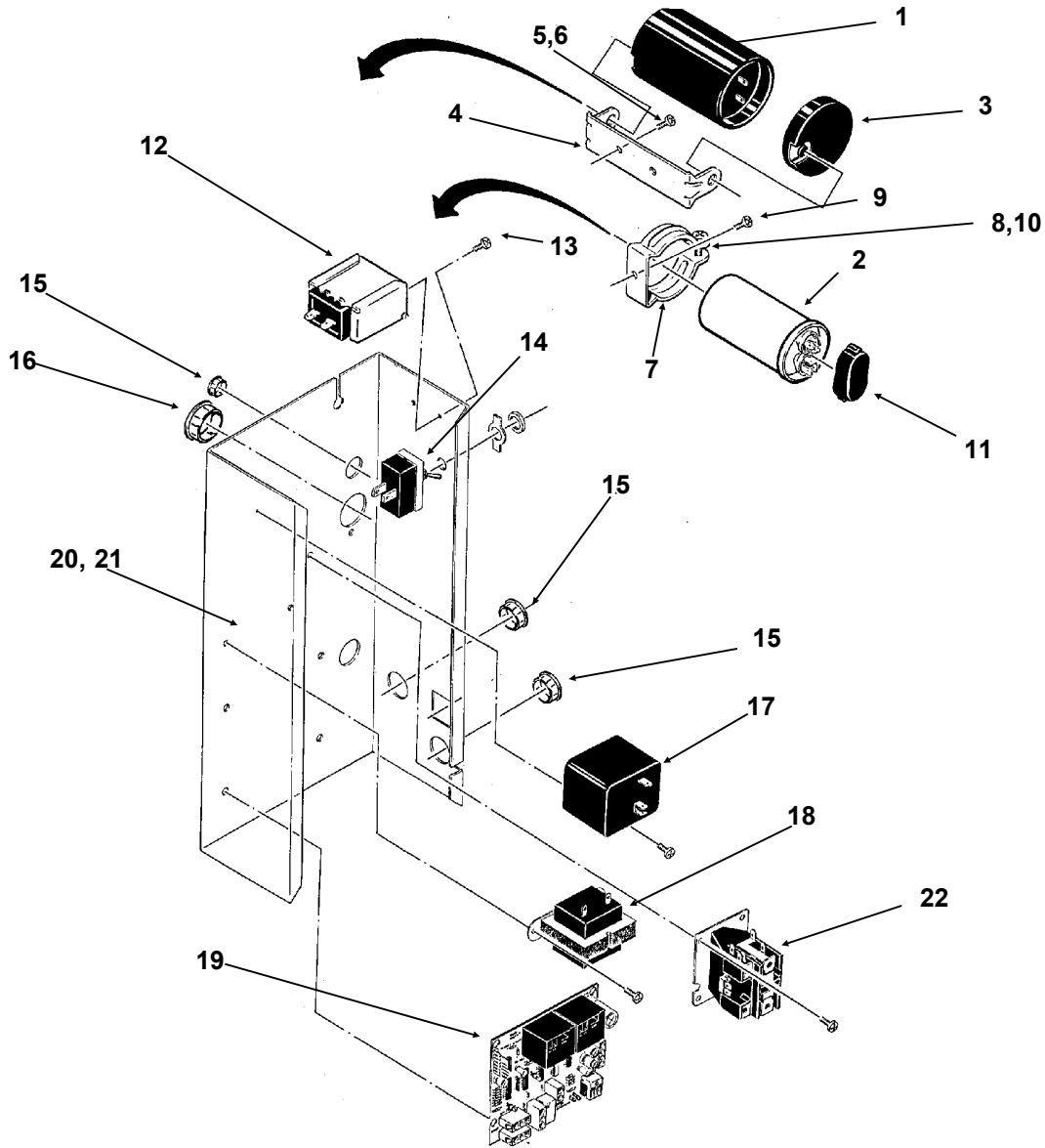

ITEM NUMBER	PART NUMBER	DESCRIPTION	ITEM NUMBER	PART NUMBER	DESCRIPTION
1.	18-1901-48	Start Capacitor	15.	12-1213-10	Snap Bushing
2.	18-1902-53	Run Capacitor	16.	12-1213-11	Snap Bushing
3.	18-4300-50	Start Capacitor Cap	17.	18-1903-46	Relay
4.	18-2200-39	Start Cap. Bracket	18.	12-2285-22	Transformer
5.	03-1638-04	Screw	19.	A37750-021	Circuit Board
6.	03-1417-15	Lockwasher	20.	No Number	Control Box
7.	A32872-001	Run Cap. Bracket	21.	A32896-001	Cont. Box Cover
8.	03-1652-02	Bolt	22.	12-2469-02	1 Phase Contactor
9.	03-1638-03	Screw		12-0739-02	3 Phase Contactor
10.	03-0255-04	Wing Nut	NOT ILLUSTRATED		
11.	13-0666-00	Terminal Cover	23.	12-2337-02	3 pin plug assy (safety circuit to circuit board)
12.	11-0420-23	Pump Down Control	24.	12-2340-01	4 pin plug assy (transformer to circuit board)
13.	03-1403-02	Screw			
14.	12-0426-01	Master Switch			

NM1250R SERVICE PARTS GEARMOTOR

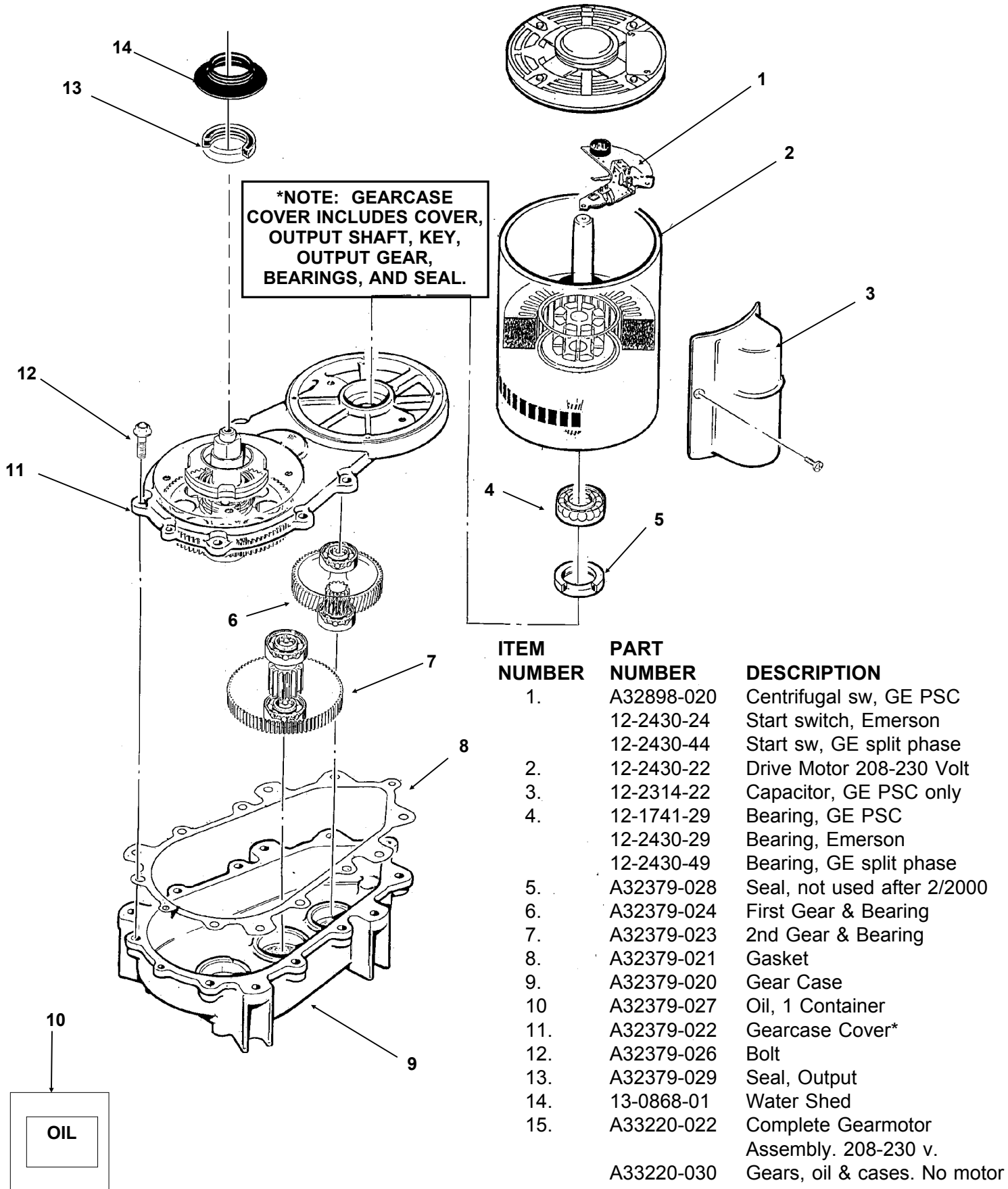

NM1250R SERVICE PARTS

RESERVOIR, DRAINS, ICE CHUTE, ICE LEVEL SENSORS

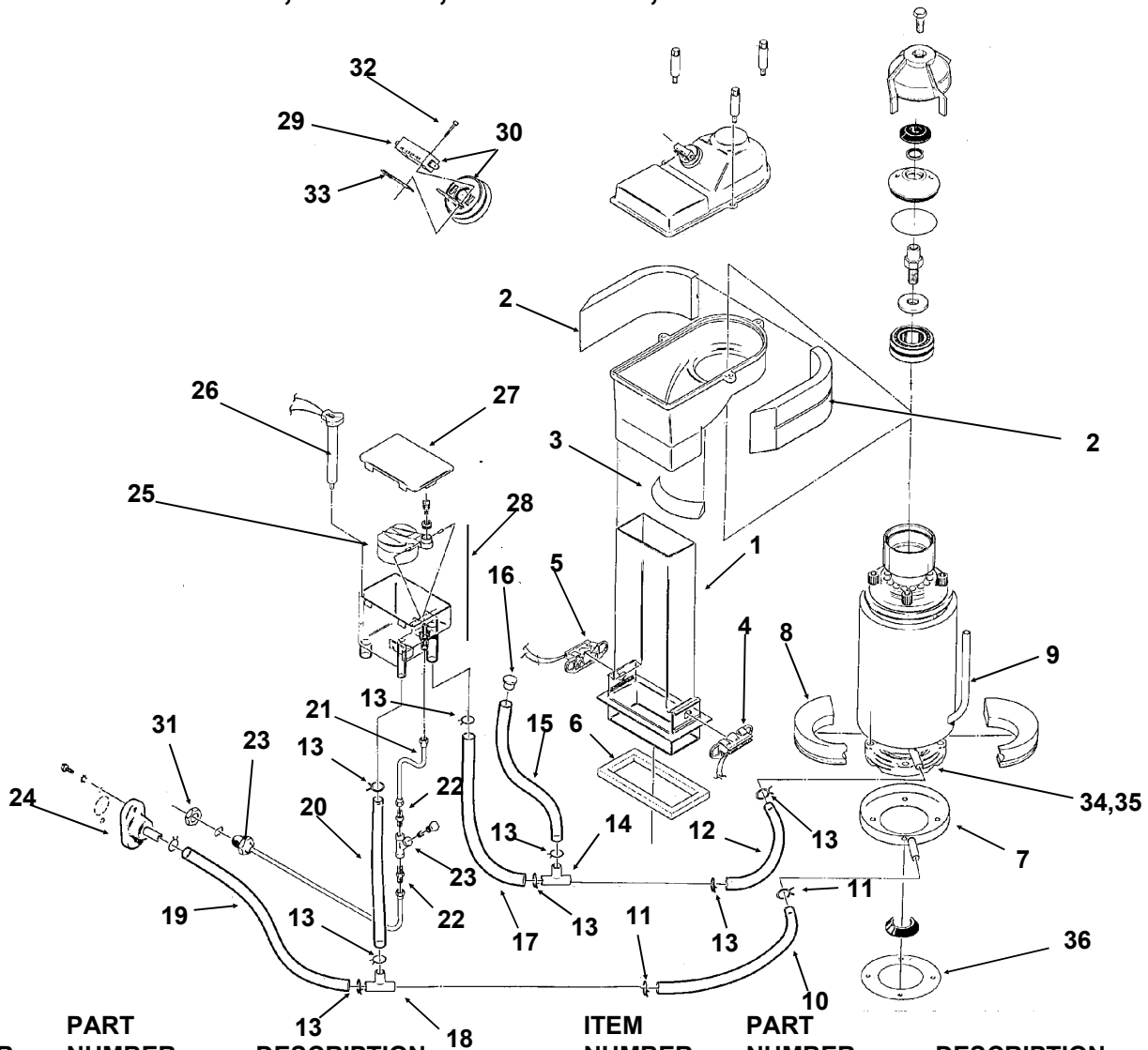

ITEM NUMBER	PART NUMBER	DESCRIPTION	ITEM NUMBER	PART NUMBER	DESCRIPTION
1.	02-2929-01	Ice Chute Lower	20.	13-0079-03	Tube, 11" Order By Ft.
2.	A32963-001	Insulation Collar Top	21.	A32748-001	Tube
3.	A33102-001	Insulation Collar Inside	22.	16-0791-01	Coupling Union
	A33210-001	Rubber Band	23.	A32878-001	Inlet Water Tube
4.	A37708-021	LED & Phototransistor Assy. (set - includes item 5)	24.	A32282-004	Drain
5.	no number	same as item 4	25.	A32922-020	Float Assy With Pin, Housing Seal, Rubber Seal, Insert & Float.
6.	A32930-001	Chute Gasket	26.	A33101-023	Thermo Probe
7.	A37705-021	Drip Pan	27.	02-2936-01	Reservoir Cover
8.	A32962-001	Insulation Collar Bottom	28.	A32929-020	Float And Reservoir Complete
9.	A32962-002	Insulation Collar Bottom	29.	12-2329-01	Switch, auto reset
10.	13-0079-03	Hose 3.3" Order By Ft.		12-2398-01	Switch, manual reset
11.	02-0538-00	Hose Clamp	30.	A32891-020	Switch Housing With Switch
12.	A33203-001	Preformed Hose	31.	03-1394-01	Pal Nut
13.	02-2814-08	Hose Clamp	32.	03-1403-09	Screw
14.	16-0670-01	Tee	33.	03-0886-00	Speed Nut
15.	13-0674-06	Tube, 14" Order By Ft.	34.	03-1405-41	Stud, Evap to GM
16.	A33205-001	Plug	35.	03-1417-13	Lock washer
17.	13-0674-06	Tube, 9" Order By Ft.	36.	13-0704-00	Drip pan gasket
18.	16-0670-02	Tee			
19.	13-0079-03	Tube, 18" Order By Ft.			

NM1250R SERVICE PARTS REMOTE CONDENSER

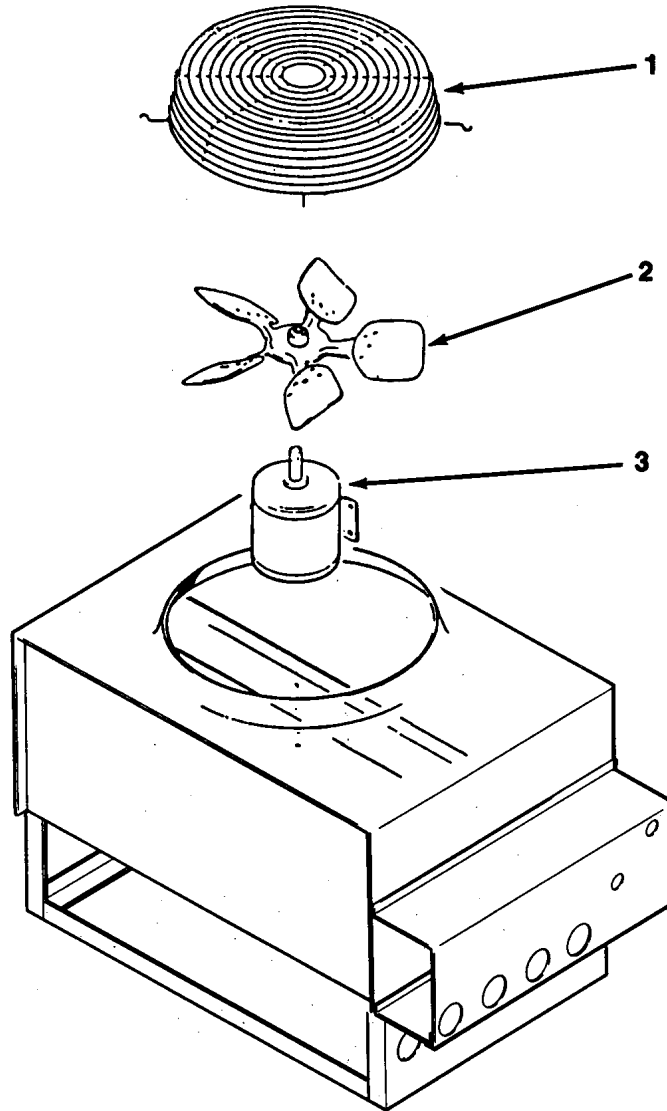

RC1451-32B or
RC1051-32A or RC1052-32A

ITEM NUMBER	PART NUMBER	DESCRIPTION
1.	02-2618-01	Fan Guard
2.	18-6304-01	Fan Blade
3.	18-5301-01	Fan Motor

RC651-32B or RC652-32B

ITEM NUMBER	PART NUMBER	DESCRIPTION
1.	02-2618-01	Fan Guard
2.	18-3733-01	Fan Blade
3.	18-5301-01	Fan Motor

NM1250R SERVICE PARTS

Component Layout Diagram

208-230/60/1

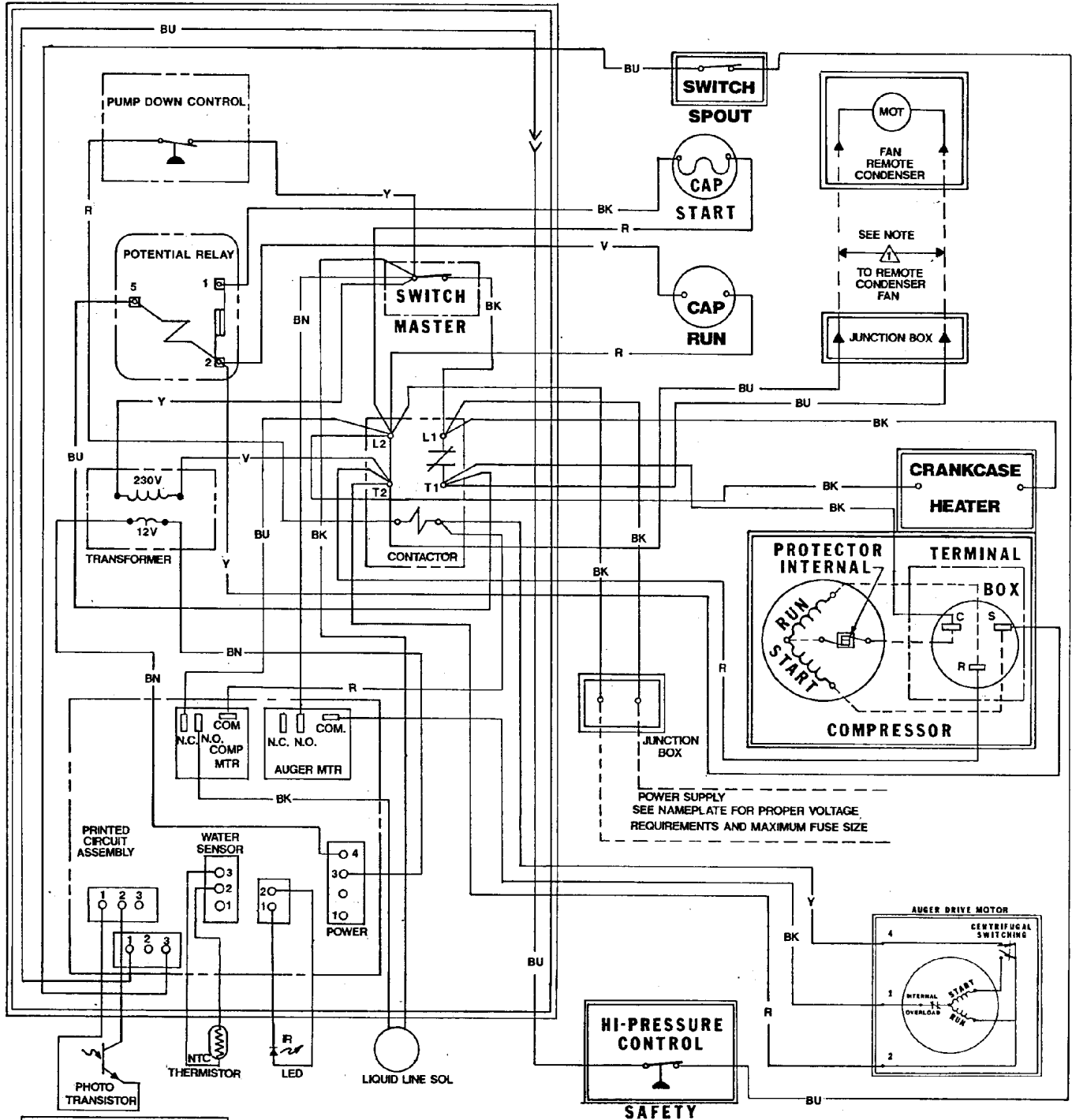

A34492-032

NM1250R SERVICE PARTS

Schematic Diagram

208-230/60/1

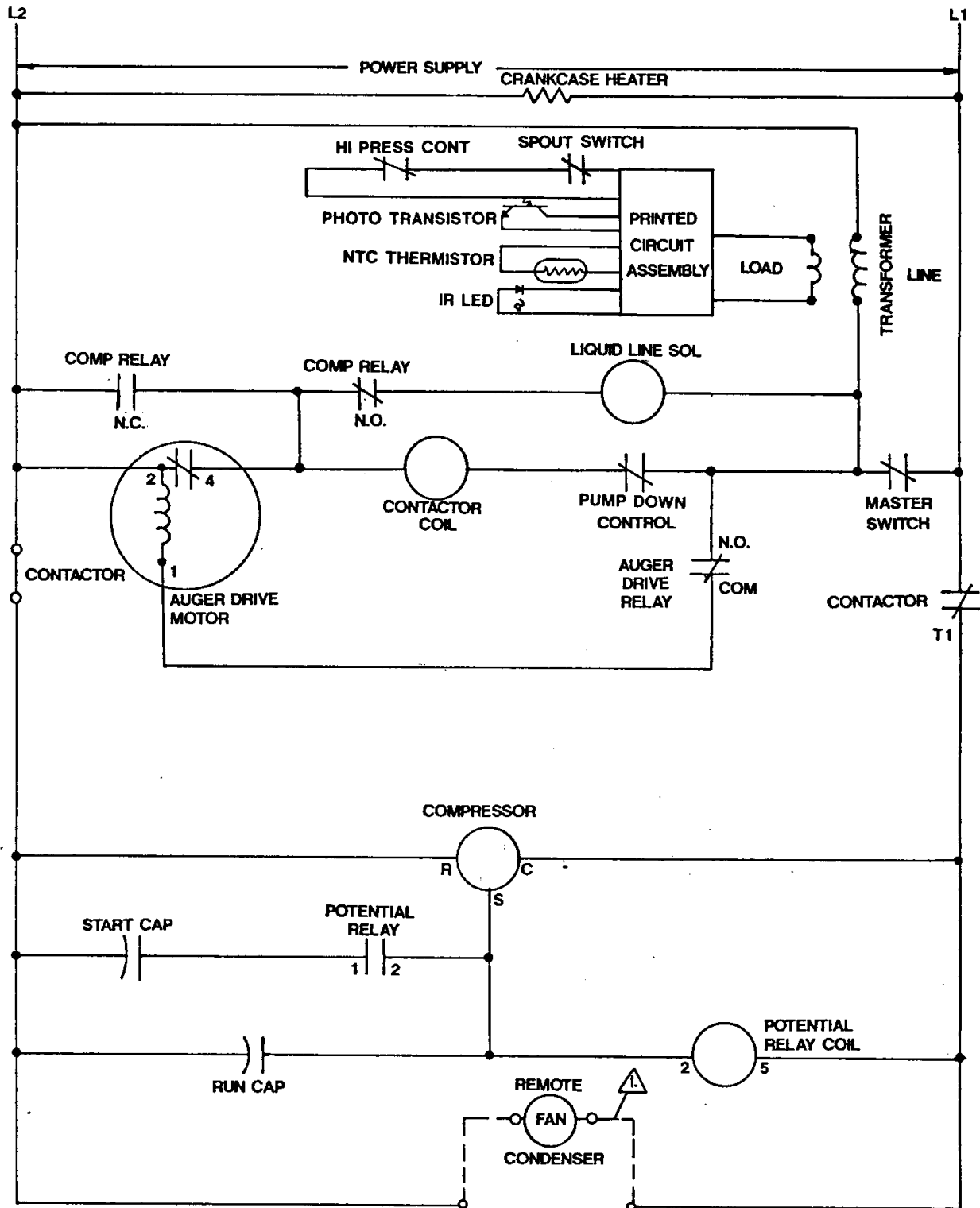

USE COPPER CONDUCTORS ONLY THIS UNIT MUST BE GROUNDED

All Controls Shown in Normal Ice Making Mode.

Note: Dashed lines indicate field wiring which must be installed in accordance with the National Electric Code Using a Minimum of 14 ga. awg. wire.

NM1250R SERVICE PARTS

Component Layout Diagram

208-230/60/3

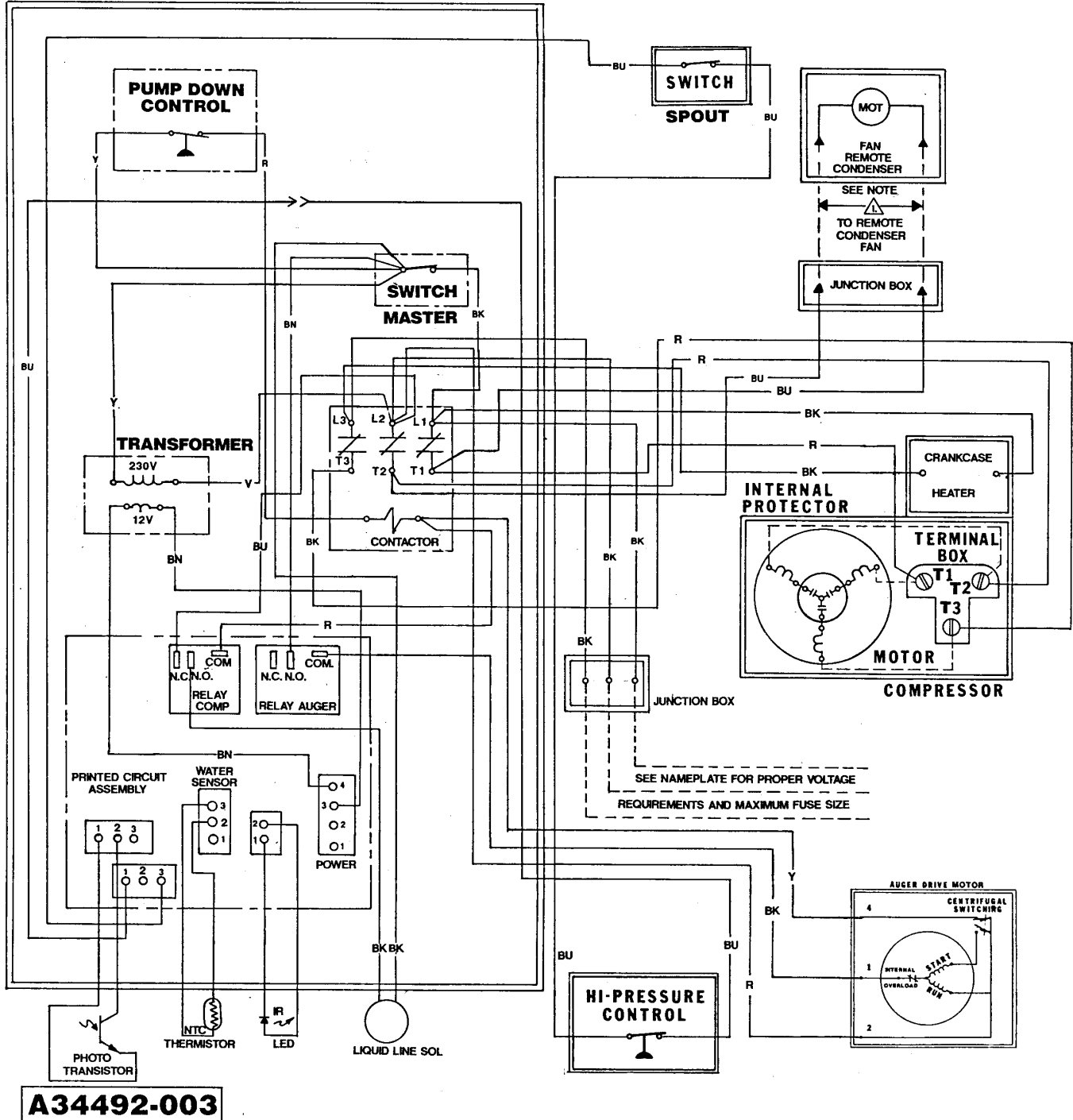

NM1250R SERVICE PARTS

Schematic Diagram

208-230/60/3

