



Model E131-YG2 / F131-YG2
OPERATORS MANUAL

Manual No. 513649

Rev.0

This manual provides basic information about the machine. Instructions and suggestions are given covering its operation and care.

The illustrations and specifications are not binding in detail. We reserve the right to make changes to the machine without notice, and without incurring any obligation to modify or provide new parts for machines built prior to date of change.

DO NOT ATTEMPT to operate the machine until instructions and safety precautions in this manual are read completely and are thoroughly understood. If problems develop or questions arise in connection with installation, operation, or servicing of the machine, contact Stoelting.



stoeltingfoodservice.com

Stoelting Foodservice Equipment
502 Highway 67
Kiel, WI 53042-1600
U.S.A.

Main Tel: 800.558.5807
Fax: 920.894.7029

Customer Service: 888.429.5920
Fax: 800.545.0662
Email: foodservice@stoelting.com

© 2014 PW Stoelting, LLC

A Few Words About Safety

Safety Information

Read and understand the entire manual before operating or maintaining Stoelting equipment.

This manual provides the operator with information for the safe operation and maintenance of Stoelting equipment. As with any machine, there are hazards associated with their operation. For this reason safety is emphasized throughout the manual. To highlight specific safety information, the following safety definitions are provided to assist the reader.

The purpose of safety symbols is to attract your attention to possible dangers. The safety symbols, and their explanations, deserve your careful attention and understanding. The safety warnings do not by themselves eliminate any danger. The instructions or warnings they give are not substitutes for proper accident prevention measures.

If you need to replace a part, use genuine Stoelting parts with the correct part number or an equivalent part. We strongly recommend that you do not use replacement parts of inferior quality.



Safety Alert Symbol:

This symbol Indicates danger, warning or caution. Attention is required in order to avoid serious personal injury. The message that follows the symbol contains important information about safety.

Signal Word:

Signal words are distinctive words used throughout this manual that alert the reader to the existence and relative degree of a hazard.



The signal word "WARNING" indicates a potentially hazardous situation, which, if not avoided, may result in death or serious injury and equipment/property damage.



The signal word "CAUTION" indicates a potentially hazardous situation, which, if not avoided, may result in minor or moderate injury and equipment/property damage.

CAUTION

The signal word "CAUTION" not preceded by the safety alert symbol indicates a potentially hazardous situation, which, if not avoided, may result in equipment/property damage.

NOTE (or NOTICE)

The signal word "NOTICE" indicates information or procedures that relate directly or indirectly to the safety of personnel or equipment/property.

TABLE OF CONTENTS

Section	Description	Page
1	Description and Specifications	
1.1	Description	1
1.2	Specifications	1
1.3	Modes of Normal Operation	4
1.4	Mix Level Indicators	6
1.5	Hopper Refrigeration	6
1.7	Motor Profile Cutout Compensation	6
2	Installation Instructions	
2.1	Safety Precautions	3
2.2	Shipment and Transit	3
2.3	Machine Installation	3
3	Initial Set-Up and Operation	
3.1	Operator's Safety Precautions	5
3.2	Operating Controls and Indicators	5
3.3	Important Information Regarding Cleaning and Sanitizing	7
3.4	Disassembly of Machine Parts	8
3.5	Cleaning Disassembled Parts	9
3.6	Sanitizing Machine Parts	9
3.7	Cleaning the Machine	9
3.8	Assembling the Machine	10
3.9	Sanitizing	10
3.10	Initial Freeze Down and Operation	11
3.11	Normal Freeze Down and Operation	12
3.12	Mix Information	12

Section	Description	Page
4	Maintenance and Adjustments	
4.1	Machine Adjustment	13
4.2	Product Consistency Adjustment	13
4.3	Locking the Control Panel	13
4.4	Obtaining Readings and Modifying Settings	13
4.5	Readings	15
4.6	Adjustments	16
4.7	Other Settings	16
4.8	Drive Belt Tension Adjustment	17
4.9	Condenser Cleaning	17
4.10	Preventative Maintenance	18
4.11	Extended Storage	18
5	Troubleshooting	
5.1	Error Codes	19
5.2	Troubleshooting	19
5.3	Troubleshooting - Machine	21
6	Replacement Parts	
6.1	Decals & Lubrication	23
6.2	Auger Shaft and Faceplate Parts	24

SECTION 1 INTRODUCTION

1.1 DESCRIPTION

The Stoelting E131YG2 and F131YG2 counter machines are gravity fed. The machines are equipped with fully automatic controls to provide a uniform product. They are designed to operate with almost any type of commercial soft serve or non-dairy mixes available, including: ice milk, ice cream, yogurt, and frozen dietary desserts.

This manual is designed to assist qualified service personnel and operators in the installation, operation and maintenance of the Stoelting E131YG2 and F131YG2 gravity machine.



Figure 1-1 E131YG2 / F131YG2 Machine

1.2 SPECIFICATIONS

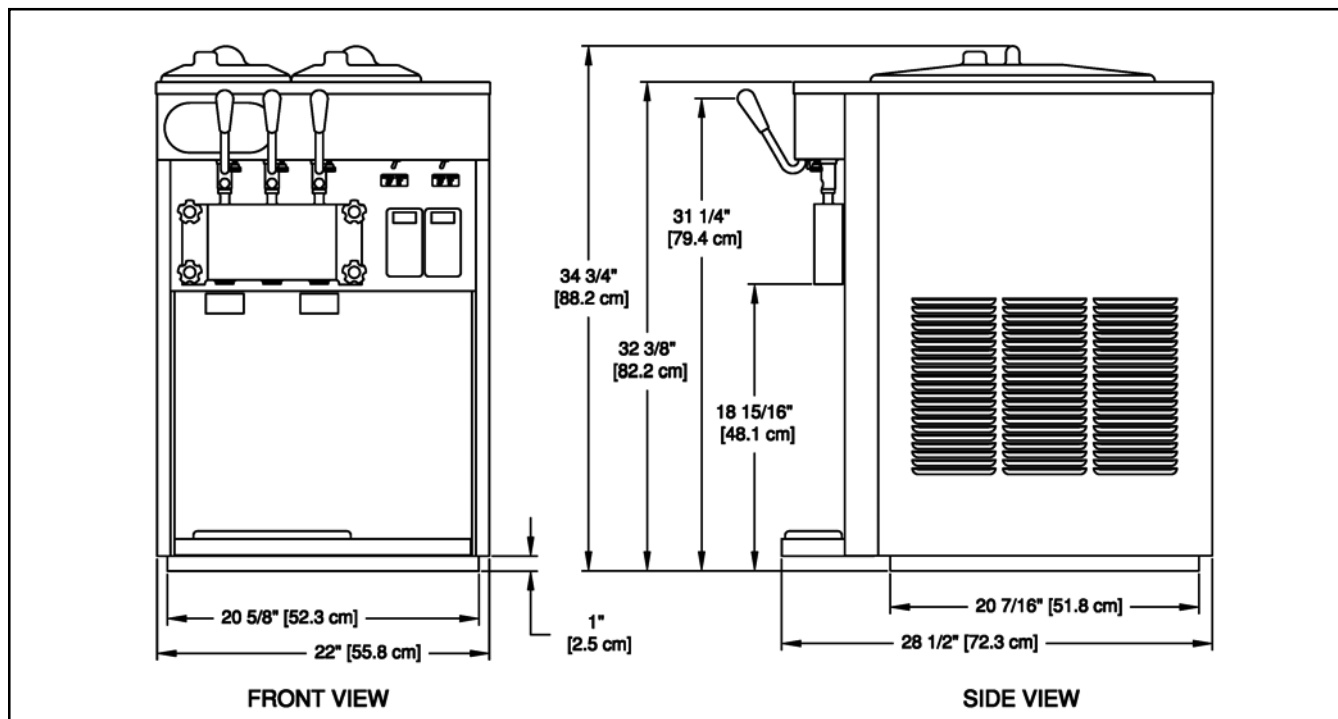

Figure 1-2 Specification

1.2 SPECIFICATIONS

Model E131YG2		
Dimensions	Machine	with crate
width	22" (55,9 cm)	28" (71,1 cm)
height	34-3/4" (88,3 cm)	40-1/4" (102,2 cm)
depth	28-1/2" (72,4 cm)	35-1/4" (89,5 cm)
Weight	370 lbs (167,8 kg)	450 lbs (204,1 kg)
Electrical	1 Phase, 208-230 VAC, 60Hz	
running amps	approximately 12A	
connection type	NEMA6-20P power cord provided	
International Option	1 Phase, 220-240 VAC, 50Hz	
Compressor	8,600 Btu/hr (R-404A)	
Drive Motor	Two - 3/4 hp	
Air Flow	Air cooled units require 3" (7,6 cm) air space on both sides	
Plumbing Fittings	Water cooled units require 3/8" N.P.T. water and drain fittings.	
Hopper Volume	Two - 3 gallon (11,35 liters)	
Freezing Cylinder Volume	Two - 0.5 gallon (2 quart), 1,89 liters	
Production Capacity	5 GPH (18,93 liters) each Freezing Cylinder 8.5 GPH (32,18 liters) both Freezing Cylinders	

Model F131YG2		
Dimensions	Machine	with crate
width	22" (55,9 cm)	28" (71,1 cm)
height	34-3/4" (88,3 cm)	40-1/4" (102,2 cm)
depth	28-1/2" (72,4 cm)	35-1/4" (89,5 cm)
Weight	385 lbs (174,6 kg)	470 lbs (213,1 kg)
Electrical	1 Phase, 208-230 VAC, 60Hz	
running amps	approximately 12A	
connection type	NEMA6-20P power cord provided	
International Option	1 Phase, 220-240 VAC, 50Hz	
Compressor	12,000 Btu/hr (R-404A)	
Drive Motor	Two - 3/4 hp	
Air Flow	Air cooled units require 3" (7,6 cm) air space on both sides	
Plumbing Fittings	Water cooled units require 3/8" N.P.T. water and drain fittings.	
Hopper Volume	Two - 3 gallon (11,35 liters)	
Freezing Cylinder Volume	Two - 0.85 gallon (3.4 quart), 3,22 liters	
Production Capacity	8 GPH (30,29 liters) each Freezing Cylinder 11.5 GPH (43,53 liters) both Freezing Cylinders	

SECTION 2 INSTALLATION INSTRUCTIONS

2.1 SAFETY PRECAUTIONS

Do not attempt to operate the machine until the safety precautions and operating instructions in this manual are read completely and are thoroughly understood.

Take notice of all warning labels on the machine. The labels have been put there to help maintain a safe working environment. The labels have been designed to withstand washing and cleaning. All labels must remain legible for the life of the machine. Labels should be checked periodically to be sure they can be recognized as warning labels.

If danger, warning or caution labels are needed, indicate the part number, type of label, location of label, and quantity required along with your address and mail to:

STOELTING
ATTENTION: Customer Service
502 Hwy. 67
Kiel, Wisconsin 53042

2.2 SHIPMENT AND TRANSIT

The machine has been assembled, operated and inspected at the factory. Upon arrival at the final destination, the entire machine must be checked for any damage which may have occurred during transit.

With the method of packaging used, the machine should arrive in excellent condition. **THE CARRIER IS RESPONSIBLE FOR ALL DAMAGE IN TRANSIT, WHETHER VISIBLE OR CONCEALED.** Do not pay the freight bill until the machine has been checked for damage. Have the carrier note any visible damage on the freight bill. If concealed damage and/or shortage is found later, advise the carrier within 10 days and request inspection. The customer must place claim for damages and/or shortages in shipment with the carrier. Stoelting, Inc. cannot make any claims against the carrier.

2.3 MACHINE INSTALLATION

WARNING

Installation must be completed by a qualified electrician/refrigeration specialist.

Incorrect installation may cause personal injury, severe damage to the machine and will void factory warranty.

Installation of the machine involves moving the machine close to its permanent location, removing all crating, setting in place, assembling parts, and cleaning.

- A. Uncrate the machine.
- B. Accurate leveling is necessary for correct drainage of machine barrel and to insure correct overrun.



Figure 2-1 Space and Ventilation Requirements

Place a bubble level on top of the machine at each corner to check for level condition. If adjustment is necessary, level the machine by turning the bottom part of each leg in or out.

- C. The machine has a base gasket that must be installed. Separate the gasket and install it with the seam to the back. Make sure the angled side of the gasket is facing up.
- D. Correct ventilation is required. The right side of the machine is the air intake and left side is the discharge. Both sides must have 3" clearance.

CAUTION

Failure to provide adequate ventilation will void warranty.

- E. Place the Main Freezer Power Off/On switch in the OFF position.
- F. Connect the power cord to the proper power supply. The plug connected to the machine is a NEMA 6-20P. Check the nameplate on your machine for proper supply. The unit must be connected to a properly grounded receptacle. The electrical cord furnished as part of the machine has a three prong grounding type plug. The use of an extension cord is not recommended, if necessary use one with a size 12 gauge or heavier with ground wire. Do not use an adapter to circumvent the grounding requirement.

WARNING

Do not alter or deform electrical plug in any way. Altering the plug to fit into an outlet of different configuration may cause fire, risk of electrical shock, product damage and will void warranty.

SECTION 3 INITIAL SET-UP AND OPERATION

3.1 OPERATOR'S SAFETY PRECAUTIONS

SAFE OPERATION IS NO ACCIDENT; observe these rules:

- A. Know the machine. Read and understand the Operating Instructions.
- B. Notice all warning labels on the machine.
- C. Wear proper clothing. Avoid loose fitting garments, and remove watches, rings or jewelry that could cause a serious accident.
- D. Maintain a clean work area. Avoid accidents by cleaning up the area and keeping it clean.
- E. Stay alert at all times. Know which switch, push button or control you are about to use and what effect it is going to have.
- F. Disconnect power for maintenance. Never attempt to repair or perform maintenance on the machine until the main electrical power has been disconnected.
- G. Do not operate under unsafe operating conditions. Never operate the machine if unusual or excessive noise or vibration occurs.

3.2 OPERATING CONTROLS AND INDICATORS

Before operating the machine, it is required that the operator know the function of each operating control. Refer to Figure 3-1 for the location of the operating controls on the machine. For the information regarding error codes displayed on the control panel, refer to the troubleshooting section of this manual.

WARNING

High voltage will shock, burn or cause death. The OFF-ON switch must be placed in the OFF position prior to disassembling for cleaning or servicing. Do not operate machine with panels removed.

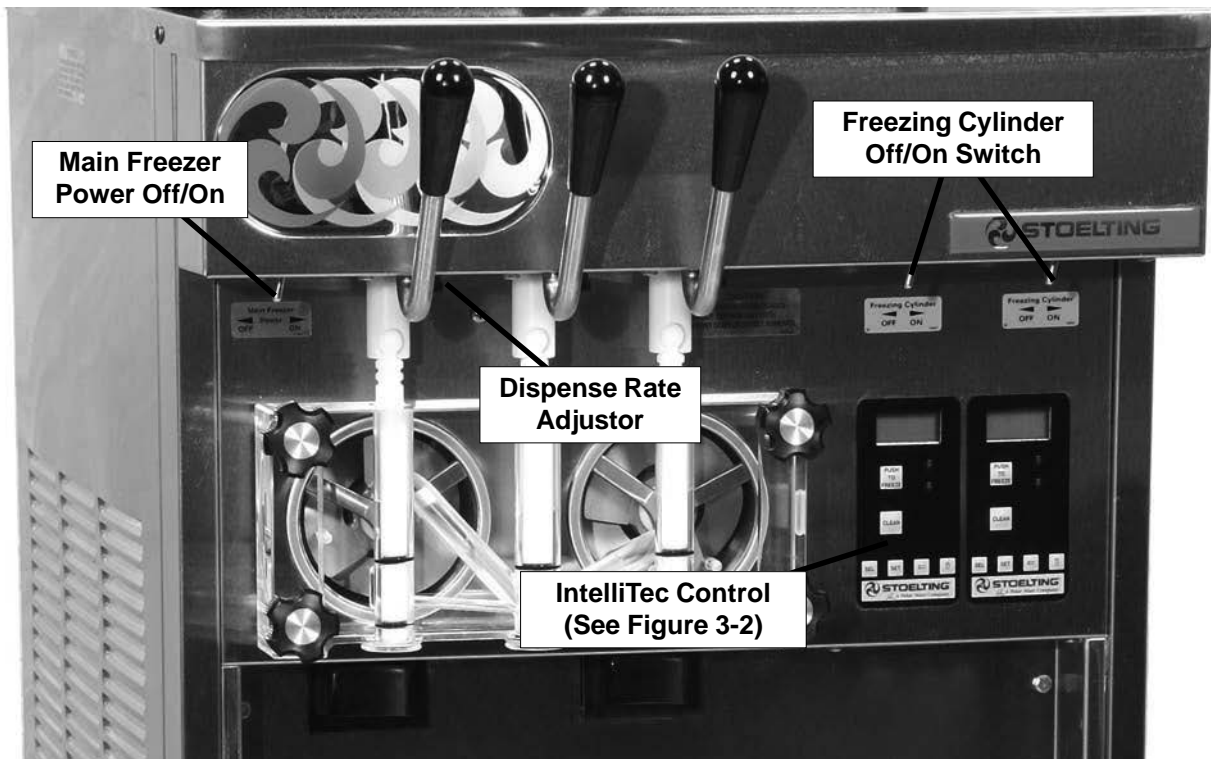

Figure 3-1 Machine Controls

A. MAIN FREEZER POWER SWITCH

The Main Freezer Power switch is a two position rocker switch that supplies power to the IntelliTec control, freezing cylinder circuits and hopper refrigeration system. When the switch is placed in the ON position, the hopper refrigeration system will run until the preset temperature is reached; then it will cycle ON and OFF to maintain that temperature.

B. FREEZING CYLINDER OFF/ON SWITCH

The Freezing Cylinder OFF/ON switch is a two position toggle switch used to supply power to the freezing cylinder control circuit. When the switch is in the OFF position, the freezing cylinder's refrigeration system and auger will not operate. When the switch is in the ON position, the machine will be operational.

C. SPIGOT SWITCH

The spigot switch is mounted to the spigot cam assembly behind the header panel. When the spigot is opened to dispense product, the spigot switch opens and the "Serve Mode" begins.

D. DISPENSE RATE ADJUSTOR

The dispense rate adjustor is located under the header panel, to the immediate right of the spigot handles. Turning the knob counterclockwise will decrease the dispense rate.

E. PUSH TO FREEZE BUTTON

The PUSH TO FREEZE button is a membrane or snap switch used to initiate "Serve Mode".

NOTE

After the PUSH TO FREEZE button is pressed, the drive motor starts. After a 3-second delay, the compressor will start.

F. LEDS

The membrane switch (touchpad) features two lights: a green LED and an amber LED. The green LED is lit during "Serve Mode". During freeze down, it is not lit. When product consistency approaches 75% in the freezing cylinder, the green LED flashes. The amber LED is on during all other modes. Both LEDs alternatively flash if an error occurs or if the freezing cylinder is off.

G. CLEAN BUTTON

The CLEAN button is a membrane, or snap switch. When the button is pressed, the freezing cycle stops and the drive motor will start. A CLEAN message will display on the LCD screen along with a 5-minute countdown timer. To exit the CLEAN mode, turn the Freezing Cylinder OFF/ON switch to the OFF position or press the CLEAN button again. If the machine is left in CLEAN for more than 20 minutes, an error code (E4) will be displayed on the display panel. Place the Freezing Cylinder OFF/ON switch in the OFF position and back in the ON position to clear this error.

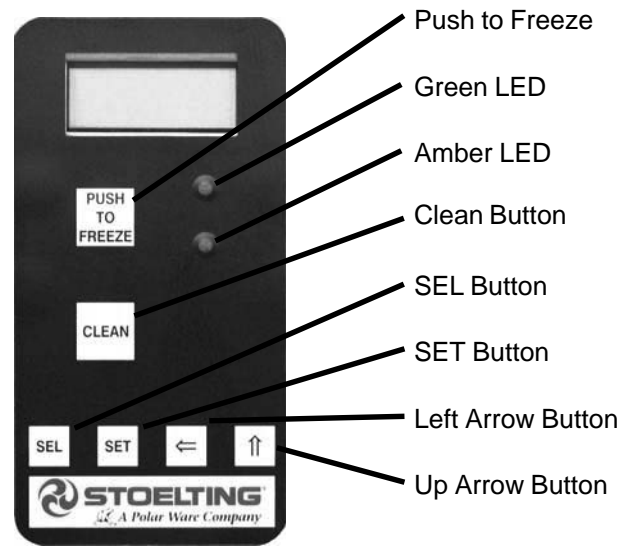

Figure 3-2 IntelliTec Control

H. DRIVE MOTOR OVERLOAD

The internal drive motor overload will trip if the drive motor is overloaded. It will reset after approximately 10-12 minutes. If the drive motor continues to trip, refer to Troubleshooting in Section 7.

I. MIX LOW LIGHT INDICATOR

A MIX LOW message will appear on the LCD display to alert the operator of a low mix condition. The message will display when there is approximately one gallon of mix left in the hopper. When the MIX LOW message is displayed, refill the hopper immediately.

L. MENU NAVIGATION BUTTONS

The Menu Navigation Buttons allow the user to display information regarding the machine's status of operation as well as adjust product consistency (Fig. 3-2).

Selection Button (SEL) The SEL button is used in combination with the up arrow button to enter into the settings of the IntelliTec control. This button is also used to navigate through the control settings menu.

Set Button (SET) The SET button is used to save a change made to the product consistency setting. It is also used to save changes when modifying control settings.

Left Arrow Button (←) If the left arrow button is pressed for 5 seconds, the display will remain lit. To turn the light off, press the left arrow button for 5 seconds. The left arrow button is used primarily to navigate through the control settings.

Up Arrow Button (↑) After pressing the SET button, the up arrow button will change the value of the product consistency setting. This button is also used to navigate through the control settings.

3.3 IMPORTANT INFORMATION REGARDING CLEANING AND SANITIZING

Soft serve machines require special consideration when it comes to food safety and proper cleaning and sanitizing.

The following information specifically covers issues for cleaning and sanitizing frozen dessert machines. This information is meant to supplement a comprehensive food safety program.

SOIL MATERIALS ASSOCIATED WITH FROZEN DESSERT MACHINES

MILKFAT/BUTTERFAT – As components of ice-cream/frozen custard mix, these soils will accumulate on the interior surfaces of the machine and its parts. Fats are difficult to remove and help attribute to milkstone buildup.

MILKSTONE – Is a white/gray film that forms on equipment and utensils that are exposed to dairy products. These films will accumulate slowly on surfaces because of ineffective cleaning, use of hard water, or both. Milkstone is usually a porous deposit, which will harbor microbial contaminants and eventually defy sanitizing efforts.

Once milkstone has formed, it is very difficult to remove. Without using the correct product and procedure, it is nearly impossible to remove a thick layer of milkstone.

(NOTE: general-purpose cleaners DO NOT remove milkstone.) This can lead to high bacteria counts and a food safety dilemma.

IT IS BEST TO CONTROL MILKSTONE ON A DAILY BASIS BEFORE IT CAN BECOME A SIGNIFICANT FOOD SAFETY PROBLEM.

In addition to food safety, milkstone can cause premature wear to machine parts, which can add to costs for replacement parts or possibly more expensive repairs if worn machine parts are not replaced once they have become excessively worn.

IMPORTANT DIFFERENCES BETWEEN CLEANING AND SANITIZING

CLEANING vs. SANITIZING

It is important to distinguish between cleaning and sanitizing. Although these terms may sound synonymous, they are not. BOTH are required for adequate food safety and proper machine maintenance.

CLEANING

- Is the removal of soil materials from a surface.
- Is a prerequisite for effective sanitizing.

NOTE

An UNCLEAN surface will harbor bacteria that can defy sanitizing efforts.

Bacteria can develop and resist sanitizing efforts within a layer of soil material (milkstone). Thorough cleaning procedures that involve milkstone removal are critical for operators of frozen dessert machines.

SANITIZING

- Kills bacteria.
- Can be effective on clean surfaces only.

NOTE

Using a SANITIZER on an unclean surface will not guarantee a clean and safe frozen dessert machine.

PROPER DAILY MAINTENANCE:

The Only Way to Assure Food Safety and Product Quality
Proper daily maintenance can involve a wide variety of products and procedures. Overall, the products and procedures fall into three separate categories. (Please note that this is a brief overview intended for informational purposes only.)

1. **CLEANING** – This involves draining mix from the freezing cylinder and rinsing the machine with water. Next, a cleaner is run through the machine. Then, the machine is disassembled and removable parts are taken to the sink for cleaning.
2. **MILKSTONE REMOVAL** – Since most cleaners do not have the ability to remove milkstone, the use of a delimer becomes necessary. Although this procedure may not be needed on a daily basis, it will usually follow the cleaning procedure. It requires letting a delimer solution soak in the machine for an extended period. Individual parts are also soaked in a deliming solution for an extended period of time (more about delimers in Additional Information).
3. **SANITIZING** – After the machine has been cleaned and contains no milkstone, the machine is reassembled. Then a FDA-approved sanitizing solution is run through the machine to kill bacteria. The machine is then ready for food preparation.

As a recommended cleaner and sanitizer for your frozen dessert machine, STERA-SHEEN has proven to be one of the best daily maintenance products for:

- **CLEANING** – Thorough removal of all solids including butterfat and milk fat.
- **MILKSTONE REMOVAL** – Complete removal of milkstone.
- **SANITIZING** – FDA-approved no rinse sanitizer for food contact surfaces.

ADDITIONAL INFORMATION

THE USE OF DELIMERS

A delimer is a strong acid that has the ability to dissolve milkstone. This type of chemical may become necessary once high levels of milkstone have developed. While these products are very effective for removing HIGH levels of milkstone, they are not ideal for two reasons:

1. **PRODUCT SAFETY** – Strong acids are dangerous chemicals. Carefully follow safety instructions provided with delimer products.

2. **MACHINE DAMAGE** – Strong acids will attack metal and rubber causing premature wear of parts. The use of a delimer needs to be closely monitored to avoid damage to machine surfaces and parts.

With proper daily use of STERA-SHEEN or its equivalent, there is no need for the use of a DELIMER.

DO NOT USE BLEACH

- BLEACH HAS ABSOLUTELY NO CLEANING PROPERTIES.
- BLEACH IS CORROSIVE. It will damage components of the machine causing premature wear and metal corrosion.

GENERAL PURPOSE CLEANERS

General purpose cleaners do not have the ability to remove milkstone. Milkstone will become a problem if not remedied with additional products and procedures.

THE USE OF CHLORINE TEST STRIPS

“Test strips” are used to determine concentrations of active chlorine in sanitizing solutions. To use the strips, tear off a small portion and submerge it into the sanitizing solution. Then, compare the color change to the color key on the side of the test strip dispenser to determine the approximate chlorine concentration.

The ideal concentration of chlorine needs to be 100 ppm (as stated by the FDA).

NOTE

Follow the directions on the container for proper concentration.

Two main factors contribute to falling chlorine concentrations in a sanitizing solution.

1. **PRODUCT USE** – As the chlorine in the solution is being used, chlorine concentrations fall.
2. **TIME** – As time passes, small amounts of chlorine “evaporate” from the solution. (That is why you can smell it.)

Sanitizing solutions should not be allowed to fall below 100 ppm chlorine. New solutions should be mixed once old solutions become ineffective.

3.4 DISASSEMBLY OF MACHINE PARTS

 WARNING
<p>High voltage will shock, burn or cause death. The OFF-ON switch must be placed in the OFF position prior to disassembling for cleaning or servicing. Do not operate machine with panels removed.</p>

Before using the machine for the first time, complete machine disassembly, cleaning and sanitizing procedures need to be followed. Routine cleaning intervals and procedures must comply with the local and state health codes.

Inspection for worn or broken parts should be made at every disassembly of the machine. All worn or broken parts should be replaced to ensure safety to both the operator and the customer and to maintain good machine performance and a quality product. Check the wear line on the auger flights on a regular basis (Fig. 3-3) and replace as needed. Frequency of cleaning must comply with the local health regulations.



Figure 3-3 Auger Flight Wear

To disassemble the machine, refer to the following steps:

A. DISASSEMBLY OF FRONT DOOR

1. Turn the Main Freezer Power Off/On switch to the OFF position.
2. Remove the knobs on the front door.
3. Remove the front door by pulling it off the studs.
4. Remove the spigot through the bottom of the front door.
5. Remove all o-rings from parts by first wiping off the lubrication using a clean towel. Then squeeze the o-ring upward to form a loop (Fig. 3-4). Roll the o-ring out of the groove.

CAUTION
<p>Do not use any type of sharp object to remove the o-rings.</p>



Figure 3-4 Removing O-Ring

B. DISASSEMBLY OF AUGER

1. Remove the front auger support and bushing.
2. Remove the auger assembly from the machine. Pull the auger out of the machine barrel slowly. As the auger is being pulled out, carefully remove each of the plastic flights with springs.
3. Keep the rear of the auger tipped up once it is clear of the freezing cylinder to prevent the rear seal assembly from dropping.
4. Wipe the spline lubricant off of the hex end of the auger with a paper towel. Remove the rear seal assembly (Fig. 3-5).
5. Unscrew the springs from the auger flights.



Figure 3-5 Rear Seal Assembly

3.5 CLEANING DISASSEMBLED PARTS

Disassembled machine parts require complete cleaning, sanitizing and air drying before assembling. Local and state health codes will dictate the procedure required. Some state health codes require a four sink process (pre-wash, wash, rinse, sanitize, air dry), while others require a three sink process (without the pre-wash step). The following procedures are a general guideline only. Consult your local and state health codes for the procedures required in your location.

- A. Prepare detergent water by mixing 2 oz. of Palmolive detergent or equivalent in 2 gallons of 90° to 110°F (32° to 43°C) water. Place all parts in the detergent solution and clean with provided brushes.
- B. Rinse all parts with clean 90° to 110°F (32° to 43°C) water.
- C. Wash the hopper and freezing cylinder with the 90° to 110°F (32° to 43°C) detergent water and brushes provided (Refer to Figure 3-6).



Figure 3-6 Clean Hoppers

- D. Clean the rear seal surfaces from the inside of the freezing cylinder with the 90° to 110°F (32° to 43°C) detergent water.

3.6 SANITIZING MACHINE PARTS

- A. Use Stera-Sheen or equivalent sanitizing solution mixed according to manufacturer's instructions to provide a 100 parts per million strength solution. Mix sanitizer in quantities of no less than 2 gallons of 90° to 110°F (32°C to 43°C) water. Any sanitizer must be used only in accordance with the manufacturer's instructions.
- B. Place all parts in the sanitizing solution for 5 minutes, then remove and let air dry completely before assembling in machine.

3.7 CLEANING THE MACHINE

The exterior should be kept clean at all times to preserve the luster of the stainless steel. A high grade of stainless steel has been used on the machine to ease cleanup. To remove spilled or dried mix, wash the exterior with 90° to 110°F (32°C to 43°C) detergent water and wipe dry.

Do not use highly abrasive materials, as they will mar the finish. A mild alkaline cleaner is recommended. Use a soft cloth or sponge to apply the cleaner. For best results, wipe with the grain of the steel.

- A. Clean the rear seal surface from inside of the freezing cylinder.
- B. Using sanitizing solution and the large barrel brush provided, sanitize the freezing cylinder by dipping the brush in the sanitizing solution and brushing the inside of the freezing cylinder.
- C. Remove the drip tray by pulling from the front panel. Clean and replace the drip tray.

3.8 ASSEMBLING MACHINE

To assemble the machine parts, refer to the following steps:

NOTICE

Petrol-Gel sanitary lubricant or equivalent must be used when lubrication of machine parts is specified.

NOTICE

The United States Department of Agriculture and the Food and Drug Administration require that lubricants used on food processing equipment be certified for this use. Use lubricants only in accordance with the manufacturer's instructions.

- A. Assemble all o-rings onto parts dry, without lubrication. Then apply a thin film of sanitary lubricant to exposed surfaces of the o-rings.
- B. Lubricate the rear seal area on the auger shaft with a thin layer of sanitary lubricant. Install the rear seal o-ring. Lubricate the outside of the rear seal o-ring with sanitary lubricant.
- C. Install the stainless steel rear seal adapter into the rear seal dry (without lubricant). Lubricate the inside metal surface of the rear seal adapter and install it onto the auger shaft. **DO NOT** lubricate the outside of the rear auger seal (Fig. 3-6).



Figure 3-6 Lubricate Rear Seal

- D. Lubricate the hex drive end of the auger with a small amount of spline lubricant. A small container of spline lubricant is shipped with the machine.
- E. Screw the springs onto the studs in the plastic flights. The springs must be screwed into the flights completely to provide proper compression.
- F. Install the two plastic flights onto the rear of the auger and insert it part way into the freezing cylinder.
- G. Install the remaining plastic flights, push the auger into the freezing cylinder and rotate slowly until the auger engages the drive shaft.

- H. Apply a thin layer of sanitary lubricant to the inside and outside of the auger support bushing. Install the bushing onto the auger support and install the auger support into the front of the auger. Rotate the auger support so that one leg of the support points straight up.
- I. Apply a thin layer of sanitary lubricant to the o-rings on the spigot body and install the spigot body through the bottom of the front door.
- K. Apply a thin film of sanitary lubricant to the door seal o-ring and fit it into the groove on the rear of the front door.
- M. Place the front door assembly on the mounting studs and the push front door against the machine carefully.
- N. Secure the front door to the machine by placing the knobs on the studs and tightening until finger tight. Do not overtighten. A proper o-ring seal can be observed through the transparent front door.

3.9 SANITIZING

Sanitizing must be done after the machine is clean and just before the machine is filled with mix. Sanitizing the night before is not effective. However, you should always clean the machine and parts after using it.

NOTE

The United States Department of Agriculture and the Food and Drug Administration require that all cleaning and sanitizing solutions used with food processing equipment be certified for this use.

When sanitizing the machine, refer to local sanitary regulations for applicable codes and recommended sanitizing products and procedures. The frequency of sanitizing must comply with local health regulations. Mix sanitizer according to manufacturer's instructions to provide a 100 parts per million strength solution. Mix sanitizer in quantities of no less than 2 gallons of 90°F to 110°F (32°C to 43°C) water. Allow sanitizer to contact the surfaces to be sanitized for 5 minutes. Any sanitizer must be used only in accordance with the manufacturer's instructions.

CAUTION

Risk of Product Damage

Avoid prolonged contact of sanitizer with machine parts. Sanitizer may cause corrosion of stainless steel parts if there is prolonged contact.

- A. Prepare 2 gallons of sanitizing solution following the manufacturer's instructions.
- B. Install the mix inlet regulator into the hopper.
- C. Pour the sanitizing solution into the hopper.

- D. Place the Main Power OFF/ON and Freezing Cylinder OFF/ON switches in the ON position. Press the CLEAN button.
- E. Check for leaks.
 1. Check for leaks at the front door seals.
 2. Check the drain tray located under the front door for leaks coming from the rear of the rear auger seal.
- F. Using a sanitized soft bristle brush (or equivalent) dipped in sanitizing solution, clean the hopper sides, mix inlet regulator and underside of the hopper cover.
- G. After five minutes, open the spigot to expel sanitizing solution. Drain all of the solution from the machine.
- H. When the solution has drained, press the CLEAN button to stop the auger and place the Main Power OFF/ON and Freezing Cylinder OFF/ON switches in the OFF position. Allow the freezing cylinder to drain completely.

The machine is now sanitized and ready for adding mix.

3.10 INITIAL FREEZE DOWN AND OPERATION

Every Stoelting soft serve machine needs to be set on site. The following adjustment will provide optimal product consistency while prolonging product life.

NOTE

The machine is designed for correct operation in ambient temperatures between 50°F and 110°F. Temperatures out of that range may cause refrigeration problems and product quality issues.

A. ADDING MIX

1. Sanitize the machine immediately before use.
2. Make sure the Freezing Cylinder OFF/ON switch is in the OFF position.
3. Fill the hopper with at least 2.5 gallons of mix.
4. Place a container under the spigot and open the spigot to allow the mix to flush out about 8 ounces (0.23 liters) of sanitizing solution and liquid mix. Close the spigot.

B. PREPARING THE INTELLITEC CONTROL

5. On the IntelliTec control, press and hold the SEL button for 8 seconds. While still holding the SEL button, press the up arrow (↑) button. The LCD will read "DISPLAY".
6. Press the left arrow (←) button once. The display will read "BASIC".
7. Press the up arrow (↑) button once. The display will read "CutOut amps".
8. Press the SET button. A cursor will start blinking under the far right digit.

9. Change the value to 8.0. Press the left arrow (←) button to move the cursor. Press the up arrow (↑) button to increase the digit. When a digit reaches 9, pressing the up arrow (↑) button again will change the value to 0.
10. After entering 8.0, press SET to save this value. The LCD will read "CutOut Set -- OK".
11. Press the SEL button. The LCD will read "CutOut amps 8.0".
12. Press the SEL button twice. The LCD will read "DISPLAY".
13. Press the up arrow (↑) button to navigate to the "°F" and "amps" readings.

C. INITIAL FREEZE DOWN

14. Press the PUSH TO FREEZE button.

NOTE

After the drive motor starts, there is a 3-second delay before the compressor starts.

15. As the product freezes, the "amps" value on the display will increase. When it reaches 2.8A, open the spigot, take a 6-8 ounce sample and measure the temperature. For most soft serve mixes, the desired temperature is between 19.0°F and 19.5°F.
16. Draw samples at every increase of 0.2A until reaching the desired consistency and temperature.

NOTE

Show the sample to the customer and make sure it meets their required consistency and temperature.

17. Record the "amps" value.
18. Place the Freezing Cylinder OFF/ON switch in the OFF position.

D. ADJUSTING THE INTELLITEC CONTROL

19. Press the SEL button. The display will read "DISPLAY".
20. Press the left arrow (←) button once. The display will read "BASIC".
21. Press the up arrow (↑) button once. The display will read "CutOut amps".
22. Change the value to the recorded value by pressing the SET button. A cursor will start blinking under the far right digit.
23. Press the left arrow (←) button to move the cursor. Press the up arrow (↑) button to increase the digit. When a digit reaches 9, pressing the up arrow (↑) button again will change the value to 0.
24. Press the SET button to save the value. The LCD will read "CutOut Set -- OK".
25. Press the SEL button. The LCD will read "CutOut amps" along with the programmed value from the previous step.

- 26. Press the SEL button three times. The LCD will read "EXITMENU".
- 27. Press the up arrow (↑) button to exit the menu.
- 28. Adjustment to the control is completed.

E. SERVING PRODUCT

- 29. Place the Freezing Cylinder OFF/ON switch in the ON position.
- 30. Press the PUSH TO FREEZE button.
- 31. When the product is at 75% consistency, the display will read "SERVE".
- 32. For normal dispensing, move the spigot handle fully open.
- 33. The machine dispenses product at a reasonable draw rate. If the machine is overdrawn, the result is a soft product or a product that will not dispense at all. If this occurs, allow the machine to run for approximately 30 seconds before dispensing more product. A dispense rate adjuster is located under the header panel, to the immediate right of the spigot handle. Turning the knob counterclockwise will decrease the dispense rate.
- 34. Do not operate the machine when the MIX LOW message is displayed. Refill hopper immediately.

NOTE

The machine has a standby and sleep mode. After a preset number of freezing cycles, it will enter the standby mode (followed by sleep mode) and remain there until someone draws product or presses the PUSH TO FREEZE button. In the sleep mode, the machine will keep the product below 41°F (5°C). Sleep modes do not take the place of cleaning and sanitizing. Federal, State, and local regulatory agencies determine frequency of cleaning and sanitizing.

3.11 NORMAL FREEZE DOWN AND OPERATION

The following section contains the recommended operating procedures for the safe operation of the machine.

- A. Sanitize immediately before use.
- B. Make sure the Freezing Cylinder Off/On switch is in the OFF position.
- C. Fill the hopper with at least 2.5 gallons of mix.
- D. Place a container under the spigot and open the spigot to allow the mix to flush out about 8 ounces (0.23 liters) of sanitizing solution and liquid mix.
- E. Place the Freezing Cylinder OFF/ON switch in the ON position.
- F. Press the PUSH TO FREEZE button.

NOTE

After the drive motor starts, there is a 3-second delay before the compressor starts.

- G. When the product is at 75% consistency, the display will read "SERVE". Open the spigot to dispense product.
- H. The machine dispenses product at a reasonable draw rate. If the machine is overdrawn, the result is a soft product or a product that will not dispense at all. If this occurs, allow the machine to run for approximately 30 seconds before dispensing more product. A dispense rate adjuster is located under the header panel, to the immediate right of the spigot handle. Turning the knob counterclockwise will decrease the dispense rate.
- I. Do not operate the machine when the MIX LOW message is displayed. Refill the mix container immediately.

NOTE

The machine has a standby and sleep mode. After a preset number of freezing cycles, it will enter the standby mode (followed by sleep mode) and remain there until someone draws product or presses the PUSH TO FREEZE button. In the sleep mode, the machine will keep the product below 41°F (5°C). Sleep modes do not take the place of cleaning and sanitizing. Federal, State, and local regulatory agencies determine frequency of cleaning and sanitizing.

3.12 MIX INFORMATION

Mix can vary considerably from one manufacturer to another. Differences in the amount of butterfat content and quantity and quality of other ingredients have a direct bearing on the finished frozen product. A change in machine performance that cannot be explained by a technical problem may be related to the mix.

Proper product serving temperature varies from one manufacturer's mix to another. Mixes should provide a satisfactory product in the 20°F to 24°F range. Diet and low-carb mixes typically freeze to proper consistency at higher temperatures.

When checking the temperature, stir the thermometer in the frozen product to get an accurate reading.

Old mix, or mix that has been stored at too high a temperature, can result in a finished product that is unsatisfactory. To retard bacteria growth in dairy based mixes, the best storage temperature range is between 33° to 38°F (0.5° to 3.3° C).

SECTION 4 MAINTENANCE AND ADJUSTMENTS

4.1 MACHINE ADJUSTMENT

This section is intended to provide maintenance personnel with a general understanding of the machine adjustments. It is recommended that any adjustments in this section be made by a qualified person.

4.2 PRODUCT CONSISTENCY ADJUSTMENT

The operator can adjust product consistency by modifying the Fine Adjustment setting on the membrane switch. This is the only adjustment that can be made by the operator without using a pass code key sequence. Increasing this setting will increase the drive motor amperage cutout and increase product consistency. Follow the instructions below to make fine adjustments to product consistency.

- A. Place the Main Freezer Power switch in the ON position.
- B. Press the SET button on the Control Panel once. Fine Adj will appear on the LCD screen.
- C. Press the up arrow button (↑) until the desired consistency setting is displayed. The higher the number, the firmer the product consistency. The control may be set from 1 to 9. The value increases by 1 each time the up arrow button is pressed. After the value reaches 9, numbering restarts at 0. The 0 setting cannot be set.
- D. Press the SET button once to save the setting and return to the current mode display.

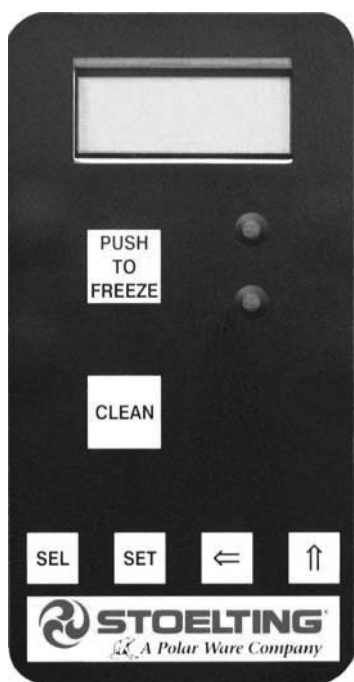

Figure 4-1 Membrane Switch

4.3 LOCKING THE CONTROL PANEL

The IntelliTec control has a tamper proof mode to prevent unauthorized use. When set, all buttons on the control panel are disabled. Follow the instructions below to lock the control panel

- A. Press and hold the PUSH TO FREEZE button for at least 5 seconds.
- B. While still holding the PUSH TO FREEZE button, press the CLEAN button once.
- C. Release both buttons. An asterisk (*) will appear on the bottom line of the display, indicating that the control is in the lock out mode.

NOTE:

Repeat steps A, B, and C to unlock the control panel.

4.4 OBTAINING READINGS AND MODIFYING SETTINGS (SERVICE PERSONNEL ONLY)

Readings and settings on the IntelliTec control are accessed through the IntelliTec Control Menu Settings (Refer to Figure 4-2). Locating machine readings and system function settings are completed using the up arrow (↑) and left arrow (←) buttons on the membrane switch. A printed IntelliTec Menu Settings sheet is located in the information pouch behind the header panel.

IntelliTec Control Readings

To obtain machine readings, locate the value on the machine's menu settings sheet and follow the steps below.

- A. Press and hold SEL button for 8 seconds. While still holding the SEL button, press the up arrow button (↑). The LCD Screen will read DISPLAY.
- B. Release both buttons.
- C. Press the up arrow button (↑) to navigate to the correct reading under DISPLAY or press the left arrow (←) button to navigate to the ERRCODES menu.
- D. Press the up arrow (↑) and left arrow (←) buttons to navigate through the rest of the readings as needed.
- E. When all readings have been obtained, press the up arrow button (↑) from ExitMenu to return to the current mode display.

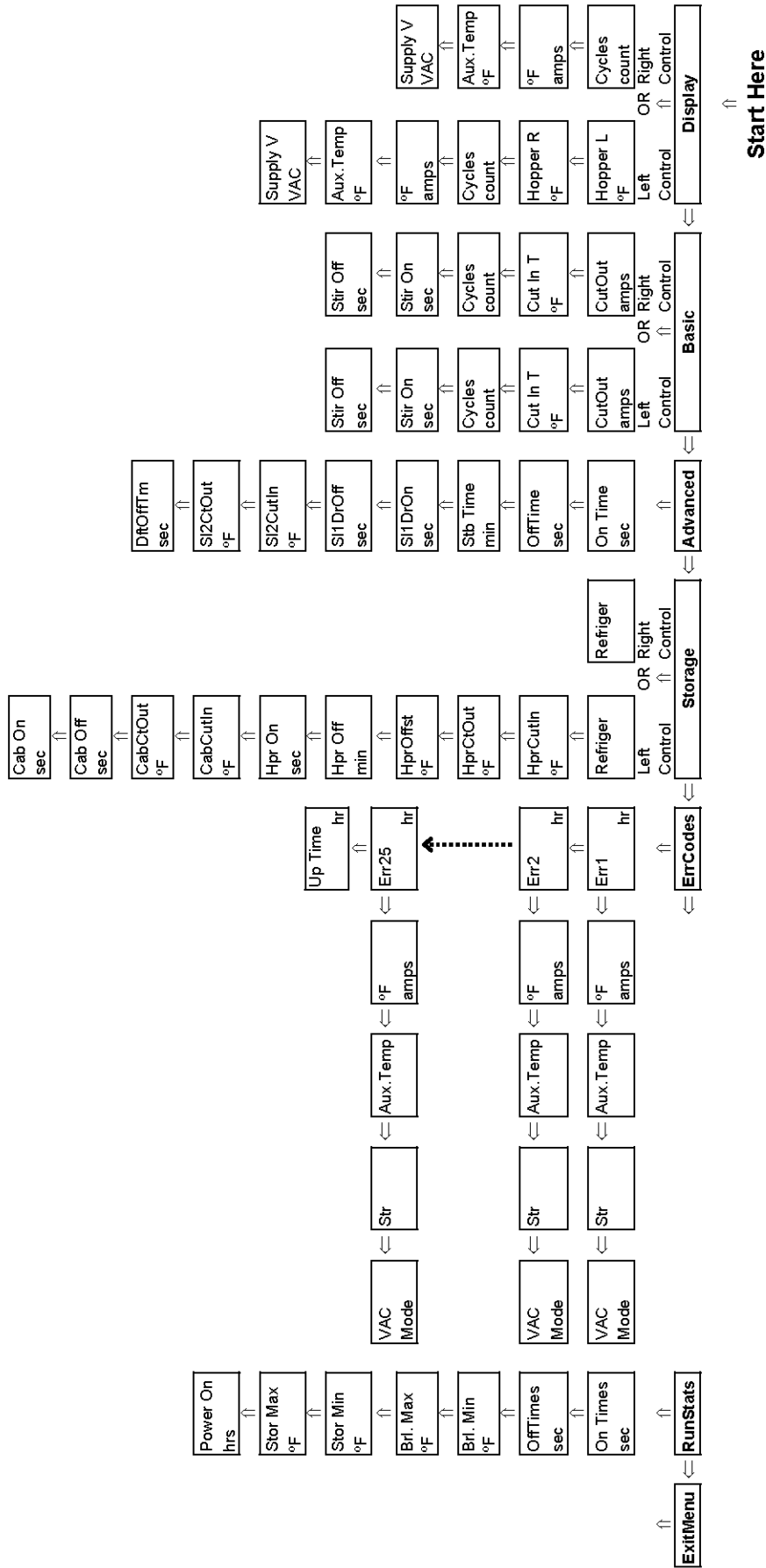

Figure 4-2 IntelliTec Control Menu Settings

Modifying Control Settings

To change the value of a system function, locate the function on the IntelliTec Settings Menu and follow the steps below.

IMPORTANT:

Before making changes to any settings, record the original values. If the setting changes do not achieve desired results, revert settings to their original values.

- A. Press and hold SEL button for 8 seconds. While still holding the SEL button, press the up arrow button (↑). The LCD Screen will read DISPLAY.
- B. Release both buttons.
- C. Press the left arrow button (←) to get to the correct menu (Basic, Advanced, or Storage).
- D. Press the up arrow button (↑) to navigate to the value that needs to be changed.
- E. Press SET button to enter edit mode.
- F. Press the up arrow button (↑) to change setting.
- G. Press SET button to save the setting and exit the edit mode.
- H. Press the up arrow (↑) and left arrow (←) buttons to navigate through the rest of the settings as needed.
- I. When all changes have been completed, press the up arrow button (↑) from ExitMenu to return to the current mode display.

4.5 READINGS (SERVICE PERSONNEL ONLY)

The IntelliTec control continuously monitors and records temperatures, voltages, amps, and error code details. Each of these readings are beneficial to service personnel when troubleshooting.

DISPLAY READINGS

Following are the readings available under the DISPLAY menu:

Hopper L (°F) / Hopper R (°F)

The temperature of the left and right hoppers are constantly monitored by the IntelliTec control.

Cycles (count)

This reading counts down the number of cycles in the current "Serve Mode". The starting value is dependant upon the Cycles setting on the IntelliTec control.

°F and amps

Suction line temperature on the freezing cylinder and drive motor amps are available on the same screen to assist with setup and troubleshooting.

Aux. Temp (°F)

This reading provides the ambient temperature around the IntelliTec control.

Supply V (VAC)

A calculated input voltage is recorded.

ERROR CODE READINGS

The following details are recorded under the ERRCODES menu for each of the last 25 error codes received:

Err1 (hours)

A numerical count of the last 25 error codes is recorded. When the 26th error has occurred the earliest error code is erased. A timer also begins when an error occurs. The timer records the number of hours since the error occurred. If power to the machine is interrupted, the timer will stop until power has been restored.

°F and amps

The suction gas temperature on the freezing cylinder and the drive motor amps are recorded at the time of the error.

Aux. Temp (°F)

Ambient temperature of the IntelliTec control is recorded at the time of the error.

Str (°F)

The storage temperature is recorded at the time of the error.

VAC and Mode

A calculated input voltage and mode at which the error occurred are recorded. Following are descriptions of each mode:

Mode	Description
0	Start of freezing cycle
1	Compressor and drive motor on
2	Stir Cycle
3	Compressor off
4	"Standby Mode"
5	"Sleep 1 Mode"
6	"Sleep 2 Mode"
7	"Clean Mode"
8	Startup
9	Storage only refrigeration
10	Freezing cycle is shut down
11	Door safety switch triggered
12	High pressure cutout

Up Time (hours)

This value is a record of the total time the machine has been in service. If power is interrupted, the timer will stop until power is restored. This timer does not reset.

RUN STATISTICS

In addition to dynamic readings and recorded error code details, the IntelliTec control records rolling averages of run statistics. Following are the readings available under the RUNSTATS menu:

On Times (sec)

The control records the time of each freezing cycle and provides a rolling average.

Off Times (sec)

The control records the time between freezing cycles and provides a rolling average.

Brl. Min (°F)

The lowest average barrel temperature is recorded.

Brl. Max (°F)

The highest average barrel temperature is recorded.

Stor Min (°F)

The lowest average hopper or cabinet temperature is recorded.

Stor Max (°F)

The highest average hopper temperature is recorded.

Power On (hrs)

This value is a record of the time the machine has been in service. If power is interrupted, the timer will reset.

4.6 ADJUSTMENTS (SERVICE PERSONNEL ONLY)

The following adjustments directly affect product consistency and length of time in "Serve Mode". The default settings have been created using a 5% milkfat soft serve mix and provide optimal product consistency while prolonging product life.

CutOut (amps)

It is recommended to change the CutOut value at initial startup and when changing mix types. Adjustments to this setting directly affect the length of the freezing cycle which changes product consistency. To properly set the CutOut value, refer to Section 3-10.

Cut In T (°F)

After the consistency value has been determined, the Cut In T value can be adjusted. The Cut In T is the temperature of the refrigerant gas in the evaporator. Changing this setting changes the temperature at which the freezing cycle starts. This value along with the CutOut value determines the range of temperatures (or "temperature window") of the product. Decreasing the temperature decreases the temperature window and, under normal use, increases the amount of freezing cycles. This creates a greater chance of product breakdown by stirring the product often. Increasing the Cut In T increases the temperature window which decreases freezing cycles and increases the chance of heat shock within the product.

Cycles (count)

This setting determines the number of freezing cycles during "Serve Mode". Increasing the value will increase the total time in "Serve Mode". Factory default is 16 cycles. This results in "Serve Mode" lasting about 2 to 2-1/2 hours without the PUSH TO FREEZE button being pressed or a spigot handle being pulled. If the PUSH TO FREEZE button is pressed or the spigot handle is pulled at any time during "Serve Mode", the Cycles count will reset.

4.7 OTHER SETTINGS (SERVICE PERSONNEL ONLY)

Changing any setting on the IntelliTec control will alter machine operation and affect the product temperature, consistency, or life. Refer to the IntelliTec Control System Settings sheet located in the information pouch behind the header panel of the machine. If any of the following settings on the IntelliTec control differ from the System Settings sheet, it is recommended to revert those settings to factory defaults.

Stir On (sec)

Adjustments to this setting affect the amount of time the auger rotates in the stir cycle. The stir cycle occurs in "Serve Mode", "Standby Mode", and "Sleep 2 Mode".

Stir Off (sec)

Adjustments to this setting affect the time between stir cycles. The stir cycle occurs in "Serve Mode", "Standby Mode", and "Sleep 2 Mode".

On Time (sec)

Increasing this value will increase the length of the freezing cycle during "Standby Mode" and result in a decrease of average product temperature in the barrel.

Off Time (sec)

Increasing this value will increase the time between freezing cycles in "Standby Mode" and result in an increase of product temperature in the barrel.

Stb Time (sec)

This setting determines the total amount of time in "Standby Mode".

SI1DrvOn (sec)

Adjustments to this setting affect the amount of time the auger rotates in the stir cycle. This stir cycle only occurs in "Sleep 1 Mode".

SI1DrOff (sec)

Adjustments to this setting affect the time between stir cycles. The stir cycle only occurs in "Sleep 1 Mode".

SI2CutIn (°F)

Changing this setting affects the temperature at which the freezing cycle starts in "Sleep 2 Mode".

SI2CtOut (°F)

Changing this setting affects the temperature at which the freezing cycle stops in "Sleep 2 Mode".

DftOffTm (sec)

In "Serve Mode", this value determines the maximum time without a freezing cycle. If this value is met, a freezing cycle will start. In the event of a freezing cylinder temperature sensor failure, this value affects the amount of time between freezing cycles during "Serve Mode".

Refriger

This setting changes how the control handles the storage refrigeration cycle. The setting for the E131 and F131 is 2 Hopper on the left control and None on the right control.

HprCutIn (°F)

This setting determines the temperature at which the hopper refrigeration cycle starts. This setting is only available on the left control.

HprCtOut (°F)

This setting determines the temperature at which the hopper refrigeration cycle stops. This setting is only available on the left control..

Hpr Off (min)

If the temperature sensor in the hopper fails, this setting determines the time between hopper refrigeration cycles. This setting is only available on the left control..

Hpr On (sec)

If the temperature sensor in the hopper fails, this setting determines the length of the hopper refrigeration cycle. This setting is only available on the left control..

4.8 DRIVE BELT TENSION ADJUSTMENT

To check belt tension, refer to Figure 4-4 and follow the steps below:



WARNING

Hazardous voltage

The Main Freezer Power switch must be placed in the OFF position when disassembling for servicing. The freezer must be disconnected from electrical supply before removing any access panel. Failure to disconnect power before servicing could result in death or serious injury.

- A. Remove the back panel.
- B. Use a Burroughs Belt Tension Gauge to set the tension for the drive belt. Set the belt tension to 35-40 lbs.
- C. If an adjustment is necessary, loosen the four motor plate retaining nuts, adjust belt tension then retighten the four nuts.
- D. Using a straightedge, check that the drive motor pulley is aligned with the speed reducer pulley. Align the pulley if necessary.

NOTE

Belt life will be increased if new drive belts are tightened after two or three weeks of operation.

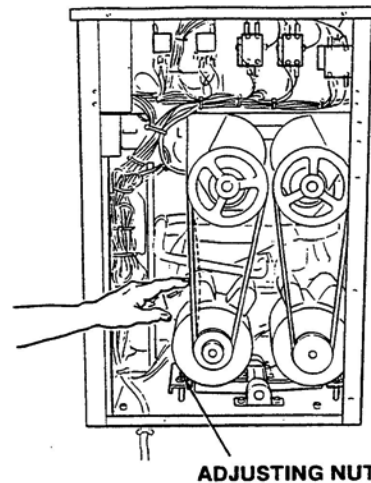

Figure 4-4 Belt Tension Adjustment

4.9 CONDENSER CLEANING

The air-cooled condenser is a copper tube and aluminum fin type. Condensing is totally dependent upon airflow. A plugged condenser filter, condenser, or restrictions in the louvered panel will restrict airflow. This will lower the capacity of the system and damage the compressor. The condenser must be kept clean of dirt and grease. The machine must have a minimum of 3" (7.5 cm) of ventilation

on the right and left sides of the unit for free flow of air. Make sure the machine is not pulling over 100° F (37° C) air from other equipment in the area.

The water-cooled condenser is a tube and shell type. The condenser needs a cool, clean supply of water to properly cool the machine, inlet and discharge lines must be 3/8" I.D. minimum.

The condenser and condenser filter require periodic cleaning. To clean, refer to the following procedures.

1. Remove the Phillips head screw from the bottom of the right side panel, and then slide the panels down and out.
2. To remove the condenser filter, grasp the top and pull off. Visually inspect for dirt. If the filter is dirty, shake or brush excess dirt off the filter and wash in warm, soapy water. Once the filter is clean rinse thoroughly in warm, clear water and shake dry, taking care not to damage the filter in any way (Figure 4-5).

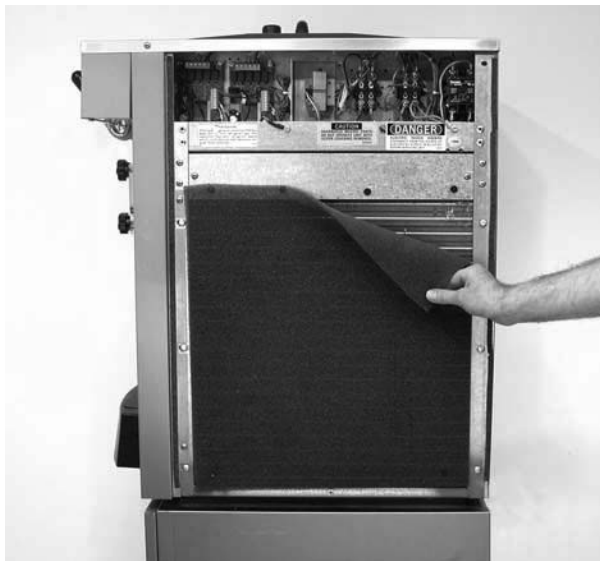

Figure 4-5 Condenser Filter Removal

3. Visually inspect the condenser for dirt by shining a light through the coil from the back (inside) of the condenser.
4. If the condenser is dirty, place a wet towel over the outside of the condenser.
5. Using compressed air or a CO2 tank, blow out the dirt from the inside of the condenser. Most of the dirt will cling to the wet towel.

NOTE

If the condenser is not kept clean, refrigeration efficiency will be lost.

4.10 PREVENTATIVE MAINTENANCE

It is recommended that a preventative maintenance schedule be followed to keep the machine clean and operating properly. The following steps are suggested as a preventative maintenance guide.

The United States department of agriculture and the food and drug administration require that lubricants used in food zones be certified for this use. Use lubricants only in accordance with the manufacturer's instructions.

- A. Daily checks
Check for any unusual noise or condition and repair immediately.
- B. Monthly checks
Check the condenser filter for dirt. (Refer to section 4.9).
- C. Quarterly Checks
Check drive belts for wear and tighten belts if necessary. (Refer to section 4.8)

4.11 EXTENDED STORAGE

Refer to the following steps for storage of the machine over any long period of shutdown time:

- A. Clean thoroughly with warm detergent all parts that come in contact with mix. Rinse in clear water and dry all parts. Do not sanitize.

NOTE

Do not let cleaning solution stand in machine barrel or mix pump during the shutdown period.

- B. Remove, disassemble, and clean the front door, and auger shaft. Leave disassembled during the shutdown period.
- C. Place the auger flights and auger support bushing in a plastic bag with a moist paper towel. This will prevent them from becoming brittle if exposed to dry air over an extended period of time (over 30 days).
- D. For water-cooled machines that are left in unheated buildings, or buildings subject to freezing, the water must be shut off and disconnected. Disconnect the water inlet fitting. The fitting is located at the rear of the machine. Run the compressor for 2 - 3 minutes to open water valve (the front door must be attached for the compressor to run). Blow out all water through water inlet. Drain the water supply line coming to the machine. Disconnect the water outlet fitting.
- E. Place the Main Freezer Power OFF/ON switch in the OFF position.
- F. Disconnect the machine from the source of electrical supply.

SECTION 5 TROUBLESHOOTING

5.1 ERROR CODES

When the machine experiences a problem, one of the following error codes will be displayed on the control panel. Each error code directs you to the system location of the malfunction.

ERROR CODE	MALFUNCTION
1	Soft
2	High Torque
3	Run Time
4	Clean
5	Freezing Cylinder Sensor
6	Hopper Sensor (single hopper machines)
7	Drive Motor
8	Cab Sensor
9	High Pressure Cutout
10	Auxiliary Sensor
11	Low Temperature
12	Left Hopper Sensor
13	Right Hopper Sensor

To return the machine to normal operation, any error causing condition must be corrected and the Freezing Cylinder Off-On switch must be placed in the Off position and back in the On position before the affected side of the machine will return to normal operation.

5.2 TROUBLESHOOTING

Error Code 1 - Soft Error

The Soft Error (E1) is an internal control board error that is logged for future analysis. The refrigeration is never stopped and the machine will continue to operate normally.

Error Code 2 - High Torque

If the control panel displays a High Torque Error (E2), the controller has sensed that the drive motor is running at 125% of the preset CutOut amp setting for 10 or more seconds. This may be due to the product consistency adjustment being set too high. Place the Main Power OFF/ON switch in the OFF position, wait until the product in the freezing cylinder thaws and return the switch to the ON position. Follow the instructions in Section 3 to reduce the product consistency by a few levels. If the error persists, contact your Authorized Stoelting Distributor for further assistance.

Error Code 3 - Run Time

The Run Time Error (E3) occurs when the compressor runs continuously for 20 minutes without the product reaching consistency in "Serve Mode" or if the product does not reach proper temperature in "Sleep 2 Mode". This error is generally caused by very low mix levels in the machine's mix container or from product breakdown. Another common cause results from a restriction preventing mix from entering the freezing cylinder. Check the mix in the hopper. If the level mix is low, add mix. If there is a possibility that the mix has broken down, clean and sanitize the machine and replace the mix with fresh product.

Ice crystals in the hopper can clog the mix inlet system and prevent mix from entering the freezing cylinder. Thoroughly thaw mix per manufacturer's recommendations. To check for ice crystals, pour a small amount of product from the mix container through a clean and sanitized sieve or strainer. If ice crystals are in the mix, check temperature of the walk-in cooler where the mix is stored.

In air cooled machines, the Run Time Error may indicate that airflow within the machine has reduced or stopped. Check the sides and top of the machine for anything that would restrict airflow.

If the error persists after attempting to clear it, contact your Authorized Stoelting Distributor for further assistance.

Error Code 4 - Clean

If the machine is left in the Clean Mode for more than 20 minutes, the control panel will display a Clean Error (E4). This condition does not reflect a problem with the machine itself. The Clean Error has been programmed into the controller as a safeguard to protect the machine from potential damage caused by the machine being accidentally left in "Clean Mode". The control will attempt to restart itself after 5 minutes. The display will then flash and read Restart. To clear the Clean Error, turn the Freezing Cylinder Off-On switch Off and back On. After restarting the machine, a refrigeration cycle will begin. This protects the product in case the clean button was pressed by mistake.

Error Code 5 - Freezing Cylinder Sensor

The Freezing Cylinder Sensor Error (E5) indicates a failure of the barrel sensor or an extreme out of range condition (< -34°F or > 99°F). If the control panel displays an E5, place the Freezing Cylinder Off-On switch Off and back On. If the error persists, contact your Authorized Stoelting Distributor for further assistance.

NOTE

When the machine encounters a Freezing Cylinder Sensor Error, the machine will continue to run using preset timers. This mode will allow the operator to continue serving product until the machine can be serviced.

Error Code 6 - Hopper Sensor (single hopper machines)

The Hopper Sensor Error (E6) will not occur on the machine.

Error Code 7 - Drive Motor

If the control panel displays a Drive Motor Error (E7), the control does not sense current coming from the drive motor. Turn the Freezing Cylinder Off-On switch Off and back On. If the error persists, contact your Authorized Stoelting Distributor for further assistance.

Error Code 8 - Cab Sensor

A Cab Sensor Error (E8) will not occur on the machine.

Error Code 9 - High Pressure Cutout

High Pressure Cutout Errors (E9) are usually caused by a dirty or inefficient condenser. If the control panel displays an E9 on an air cooled machine, check for proper air clearance around the machine. If the error persists, contact your Authorized Stoelting Distributor for further assistance.

Error Code 10 - Auxiliary Sensor

An Auxiliary Temperature Sensor Error (R10) occurs if the temperature sensor on the control board fails. Turn the Freezing Cylinder Off-On switch Off and back On. If the error persists, contact your Authorized Stoelting Distributor for further assistance.

Error Code 11 - Low Temperature

The Low Temperature Error (E11) occurs when the temperature of the gas refrigerant at the barrel sensor falls below -20°F. Although the machine will not shut down, the active freezing cycle will immediately end. This error usually occurs when the machine continues to run in a low mix condition or if the machine runs out of mix. The product towards the front of the barrel tends to freeze solid.

Error Code 12 - Left Hopper Sensor

The Left Hopper Sensor Error (E12) indicates a failure of the hopper sensor or an extreme out of range condition (< -34°F or > 99°F). If the control panel displays an E12, turn the left Freezing Cylinder Off-On switch Off and back On. If the error persists, contact your Authorized Stoelting Distributor for further assistance.

NOTE:

If the right control panel shows an E12, make sure the storage setting is set to NONE.

Error Code 13 - Right Hopper Sensor

The Right Hopper Sensor Error (E13) indicates a failure of the hopper sensor or an extreme out of range condition (< -34°F or > 99°F). If the control panel displays an E13, turn the right Freezing Cylinder Off-On switch Off and back On. If the error persists, contact your Authorized Stoelting Distributor for further assistance.

NOTE:

If the right control panel shows an E13, make sure the storage setting is set to NONE.

Alternating Flashing Control Panel Lights

The display panel lights will flash in an alternating sequence under any error codes. Clear the error and place the Freezing Cylinder Off-On switch in the Off position and back in the On position.

5.3 TROUBLESHOOTING - MACHINE

PROBLEM	POSSIBLE CAUSE	REMEDY
Machine does not run.	<ol style="list-style-type: none"> 1. Power to machine is off. 2. Blown fuse or tripped circuit. 3. Freeze-up (auger will not turn). 4. High pressure cut-out tripped. 5. Front door not in place. 	<ol style="list-style-type: none"> 1. Supply power to machine. 2. Replace or reset. 3. Turn CLEAN-OFF-ON switch to OFF (middle) position for 15 minutes, then restart. 4. Wait until automatic reset for machine to start. 5. Assemble front door in place.
Machine will not shut off.	<ol style="list-style-type: none"> 1. Drive belt failure. 2. Consistency temperature setting is too firm. 3. Refrigeration problem. 	<ol style="list-style-type: none"> 1. Replace drive belt. 2. Turn Consistency Adjustment knob counter-clockwise. 3. Check system. (See Section 5)
Product is too firm.	<ol style="list-style-type: none"> 1. CutOut setting is too high. 2. Product break down. 	<ol style="list-style-type: none"> 1. Adjust the CutOut amps (See Section 3-10). 2. Drain, clean and sanitize machine. Fill with fresh mix.
Product is too soft.	<ol style="list-style-type: none"> 1. No vent space for free flow of cooling air. 2. Air temperature entering condenser is above 100°F. 3. Condenser is dirty. 4. CutOut setting is too low. 5. Stabilizers in mix are broken down. 6. Auger is assembled incorrectly. 7. Refrigeration problem. 	<ol style="list-style-type: none"> 1. A minimum of 3" of vent space required. (See Section 2) 2. Change location or direct hot air away from machine. 3. Clean. (See Section 3) 4. Adjust the CutOut amps (See Section 3-10). 5. Remove mix, clean, sanitize and freeze down with fresh mix. 6. Remove mix, clean, reassemble, sanitize and freeze down. 7. Check system. (See Section 5)
Product does not dispense.	<ol style="list-style-type: none"> 1. No mix in hopper. 2. Capacity of machine is being exceeded. 3. Drive motor overload tripped. 4. Drive belt failure. 5. Freeze-up (Auger will not turn). 	<ol style="list-style-type: none"> 1. Fill hopper with mix. 2. Slow up on the draw rate. 3. Wait for automatic reset. (If condition continues, call distributor for service.) 4. Replace drive belt. 5. Turn CLEAN-OFF-ON switch to OFF (middle) position for 15 minutes, then restart.
Drive belt slipping or squealing.	<ol style="list-style-type: none"> 1. Worn drive belt. 2. Freeze-up (Auger will not turn). 3. Not tensioned properly 	<ol style="list-style-type: none"> 1. Replace drive belt. 2. Turn CLEAN-OFF-ON switch to OFF (middle) position for 15 minutes, then restart. 3. Adjust belt tension
Rear auger seal leaks.	<ol style="list-style-type: none"> 1. Outside surface of rear auger seal is lubricated. 2. Rear seal missing or damaged. 3. Seal o-ring missing, damaged or installed incorrectly. 4. Worn or scratched auger shaft. 	<ol style="list-style-type: none"> 1. Clean lubricant from outside of rear seal, lubricate inside of seal and reinstall. 2. Check or replace. 3. Check. or replace. 4. Replace auger shaft.
Front door leaks.	<ol style="list-style-type: none"> 1. Front door knobs are loose. 2. Spigot parts are not lubricated. 3. Chipped or worn spigot o-rings. 4. O-rings or spigot installed wrong. 5. Inner spigot hole in front door nicked or scratched. 	<ol style="list-style-type: none"> 1. Tighten knobs. 2. See Section 3. 3. Replace o-rings. 4. Remove spigot and check o-ring. 5. Replace front door.

SECTION 6 REPLACEMENT PARTS

6.1 DECALS AND LUBRICATION

Part	Description	Quantity
208135	Brush - 4" X 8" X 16" (Barrel)	1
208380	Brush - 1/4" X 3" X 14"	1
208401	Brush - 1" X 3" X 10"	1
208467	Brush - 3/8" X 1" X 5"	1
236025	Card - Cleaning Instruction	1
324065	Decal - Water Inlet	1
324105	Decal - Caution Electrical Shock	1
324106	Decal - Caution Electrical Wiring Materials	1
324107	Decal - Caution Hazardous Moving Parts	1
324141	Decal - Caution Rotating Blades	1
324200	Decal - High Pressure Cut-Out (Water-Cooled)	1
324208	Decal - Attention Refrigerant Leak Check	1
324393	Decal - Stoelting Swirl Logo (Drip Tray Support)	1
324509	Decal - Cleaning Instructions	1
324566	Decal - Wired According To	1
324584	Decal - Adequate Ventilation 3"	1
324592	Decal - Hold Ready	1
324593	Decal - Power	1
324594	Decal - Attention Heat Sensitive	1
324612	Decal - Control	1
324686	Decal - Danger Automatic Start	1
324803	Decal - Domed Stoelting Logo (Large) (Header Panel)	1
324804	Decal - Domed Stoelting Swirl (Header Panel)	1
324806	Decal - Domed A & W Logo (Header Panel)	1
324825	Decal - Main Freezer Power	1
324827	Decal - Freezing Cylinder	1
324889	Decal - Orange Tree	1
368140	Filter - Air (Condenser)	1
396241	Gasket - Freezer Base	1
508048	Lubricant - Spline (2 oz Squeeze Tube)	1
508135	Petrol Gel - 4 oz Tube	1
513650	Manual - Service	-
1159584	Mix Out Audible Signal	-
2177917	Brush Kit	-

6.2 AUGER SHAFT AND FACEPLATE PARTS

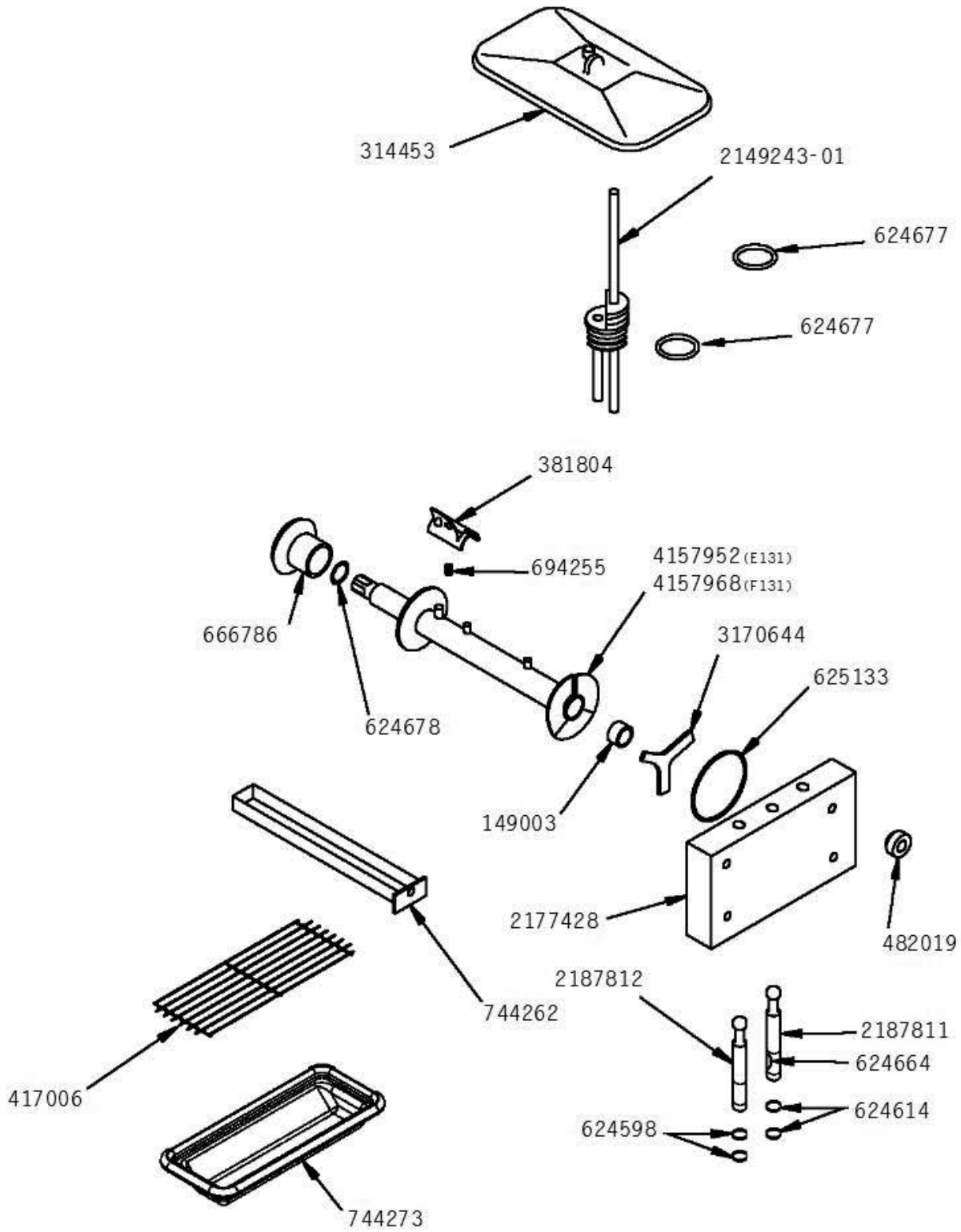

6.2 AUGER SHAFT AND FACEPLATE PARTS (CONTINUED)

Part	Description	Quantity
149003	Bushing - Front Auger Support	2
232734	Cap - Rosette - Teardrop	3
266076	Clip - Drip Tray	2
314453	Cover - Hopper	2
381804	Auger Flight	6 (E131) 8 (F131)
417006	Grid - Drip Tray (Metal)	1
482019	Knob - Front Door (Black)	4
624598-5	O-Ring - Outside Spigot - Black (5 Pack)	4
624614-5	O-Ring - Top & Bottom Center Spigot - Black (5 Pack)	2
624664-5	O-Ring - Middle Center Spigot - Black (5 Pack)	1
624677-5	O-Ring - Mix Inlet - Black (5 Pack) (Spigot Extension - Ser. #5687 Plus)	4
624678-5	O-Ring - Rear Seal - Black (5 Pack)	2
625133	O-Ring - Front Door - Red	2
666786	Seal - Rear Auger - Black	2
694255	Spring - Auger Flight	6 (E131) 8 (F131)
744260-SV	Tray - Drip	1
744273	Tray - Drain (Black Plastic)	1
1159501	O-Ring & Bushing Kit	-
1177429	O-Ring & Spigot Extension Kit	-
2149243-01	Mix Inlet Assembly - 3/16" Hole - Standard Length (2A)	2
2177072	Extension - Spigot - 1.5"	-
2177073	Extension - Spigot - 2.5"	-
2177074	Extension - Spigot - 3.2"	-
2177428	Door w/Pins (Requires #1177429)	1
2187811	Spigot Body - Center	1
2187812	Spigot Body - Outer	2
3170644	Support - Front Auger	2
4157952	Auger Shaft	2 (E131)
4157968	Auger Shaft	2 (F131)



WARRANTY SOFT SERVE / SHAKE FREEZERS

1. Scope:

Stoelting, LLC warrants to the first user (the "Buyer") that the freezer cylinders, hoppers, compressors, drive motors, speed reducers, augers and auger flights of Stoelting soft serve / shake freezers will be free from defects in materials and workmanship under normal use and proper maintenance appearing within five (5) years, and that all other components of such equipment manufactured by Stoelting will be free from defects in material and workmanship under normal use and proper maintenance appearing within twelve (12) months after the date that such equipment is originally installed.

2. Disclaimer of Other Warranties:

THIS WARRANTY IS EXCLUSIVE; AND STOELTING HEREBY DISCLAIMS ANY IMPLIED WARRANTY OF MERCHANTABILITY OR FITNESS FOR PARTICULAR PURPOSE.

3. Remedies:

Stoelting's sole obligations, and Buyer's sole remedies, for any breach of this warranty shall be the repair or (at Stoelting's option) replacement of the affected component at Stoelting's plant in Kiel, Wisconsin, or (again, at Stoelting's option) refund of the purchase price of the affected equipment, and, during the first twelve (12) months of the warranty period, deinstallation/reinstallation of the affected component from/into the equipment. Those obligations/remedies are subject to the conditions that Buyer (a) signs and returns to Stoelting, upon installation, the Checklist/Warranty Registration Card for the affected equipment, (b) gives Stoelting prompt written notice of any claimed breach of warranty within the applicable warranty period, and (c) delivers the affected equipment to Stoelting or its designated service location, in its original packaging/crating, also within that period. Buyer shall bear the cost and risk of shipping to and from Stoelting's plant or designated service location.

4. Exclusions and Limitations:

This warranty does not extend to parts, sometimes called "wear parts", which are generally expected to deteriorate and to require replacement as equipment is used, including as examples but not intended to be limited to o-rings, auger seals, auger support bushings and drive belts. All such parts are sold

AS IS.

Further, Stoelting shall not be responsible to provide any remedy under this warranty with respect to any component that fails by reason of negligence, abnormal use, misuse or abuse, use with parts or equipment not manufactured or supplied by Stoelting, or damage in transit.

THE REMEDIES SET FORTH IN THIS WARRANTY SHALL BE THE SOLE LIABILITY STOELTING AND THE EXCLUSIVE REMEDY OF BUYER WITH RESPECT TO EQUIPMENT SUPPLIED BY STOELTING; AND IN NO EVENT SHALL STOELTING BE LIABLE FOR ANY INCIDENTAL OR CONSEQUENTIAL DAMAGES, WHETHER FOR BREACH OF WARRANTY OR OTHER CONTRACT BREACH, NEGLIGENCE OR OTHER TORT, OR ON ANY STRICT LIABILITY THEORY.

January 30, 2003
721-013, Rev. 0