



**Model F431**  
**OPERATORS MANUAL**  
Manual No. 513604 Rev.5



This manual provides basic information about the machine. Instructions and suggestions are given covering its operation and care.

The illustrations and specifications are not binding in detail. We reserve the right to make changes to the machine without notice, and without incurring any obligation to modify or provide new parts for machines built prior to date of change.

**DO NOT ATTEMPT** to operate the machine until instructions and safety precautions in this manual are read completely and are thoroughly understood. If problems develop or questions arise in connection with installation, operation, or servicing of the machine, contact Stoelting.



[stoeltingfoodservice.com](http://stoeltingfoodservice.com)

Stoelting Foodservice Equipment  
502 Highway 67  
Kiel, WI 53042-1600  
U.S.A.

Main Tel: 800.558.5807  
Fax: 920.894.7029

Customer Service: 888.429.5920  
Fax: 800.545.0662  
Email: [foodservice@stoelting.com](mailto:foodservice@stoelting.com)

© 2014 PW Stoelting, LLC

---

## ***A Few Words About Safety***

### **Safety Information**

**Read and understand the entire manual before operating or maintaining Stoelting equipment.**

This manual provides the operator with information for the safe operation and maintenance of Stoelting equipment. As with any machine, there are hazards associated with their operation. For this reason safety is emphasized throughout the manual. To highlight specific safety information, the following safety definitions are provided to assist the reader.

The purpose of safety symbols is to attract your attention to possible dangers. The safety symbols, and their explanations, deserve your careful attention and understanding. The safety warnings do not by themselves eliminate any danger. The instructions or warnings they give are not substitutes for proper accident prevention measures.

If you need to replace a part, use genuine Stoelting parts with the correct part number or an equivalent part. We strongly recommend that you do not use replacement parts of inferior quality.



### **Safety Alert Symbol:**

**This symbol** Indicates danger, warning or caution. Attention is required in order to avoid serious personal injury. The message that follows the symbol contains important information about safety.

### **Signal Word:**

Signal words are distinctive words used throughout this manual that alert the reader to the existence and relative degree of a hazard.



The signal word "WARNING" indicates a potentially hazardous situation, which, if not avoided, may result in death or serious injury and equipment/property damage.



The signal word "CAUTION" indicates a potentially hazardous situation, which, if not avoided, may result in minor or moderate injury and equipment/property damage.

### **CAUTION**

The signal word "CAUTION" not preceded by the safety alert symbol indicates a potentially hazardous situation, which, if not avoided, may result in equipment/property damage.

### **NOTE (or NOTICE)**

The signal word "NOTICE" indicates information or procedures that relate directly or indirectly to the safety of personnel or equipment/property.

# TABLE OF CONTENTS

<b>Section</b>	<b>Description</b>	<b>Page</b>
<b>Section 1</b>	<b>Introduction</b>	
1.1	Description.....	1
1.2	Specifications .....	2
<b>Section 2</b>	<b>Installation Instructions</b>	
2.1	Safety Precautions .....	3
2.2	Shipment & Transit .....	4
2.3	Machine Installation.....	4
2.4	Installing Permanent Wiring.....	4
2.5	Mix Pump.....	5
<b>Section 3</b>	<b>Initial Set-Up and Operation</b>	
3.1	Safety Precautions .....	9
3.2	Operating Controls and Indicators.....	9
3.3	Important Cleaning and Sanitizing Information.....	11
3.4	Disassembly of Machine Parts .....	12
3.5	Cleaning Disassembled Parts .....	13
3.6	Sanitizing Machine Parts.....	14
3.7	Cleaning the Machine.....	14
3.8	Assembling the Machine .....	14
3.9	Sanitizing Assembled Machine.....	15
3.10	Initial Freeze Down and Operation.....	16
3.11	Normal Freeze Down and Operation.....	18
3.12	Mix Information.....	18
3.13	Operation of Mix Pump.....	19
3.14	Mix Pump Cleaning .....	19
3.15	Disassembly and Inspection of Removable Parts .....	19

<b>Section</b>	<b>Description</b>	<b>Page</b>
<b>Section 4</b>	<b>Maintenance and Adjustments</b>	
4.1	Machine Adjustment .....	21
4.2	Product Consistency Adjustment.....	21
4.3	Locking Out Control Panel.....	21
4.4	Obtaining Readings and Modifying Settings (Service Personnel Only).....	21
4.5	Readings (Service Personnel Only) .....	22
4.6	Adjustments (Service Personnel Only).....	23
4.7	Other Settings (Service Personnel Only).....	23
4.8	Overrun Adjustment.....	24
4.9	Mix Pump Hose Reposition .....	25
4.10	Mix Pump Hose Replacement .....	25
4.11	Cab Temperature Adjustment .....	26
4.12	Drive Belt Tension Adjustment.....	26
4.13	Condenser Cleaning (Air Cooled Machines) .....	27
4.14	Preventative Maintenance .....	27
4.15	Extended Storage.....	27
<b>Section 5</b>	<b>Troubleshooting</b>	
5.1	Error Codes .....	29
5.2	Troubleshooting - Error Codes .....	29
5.3	Troubleshooting - Machine .....	31
5.4	Troubleshooting - Mix Pump.....	32
<b>Section 6</b>	<b>Replacement Parts</b>	
6.1	Decals and Miscellaneous Parts .....	35
6.2	Front Door and Auger Parts.....	36
6.3	Cab Tubing Assembly .....	37

# SECTION 1 INTRODUCTION

## 1.1 DESCRIPTION

The Stoelting F431 floor model machine is pressure fed. The machine is equipped with fully automatic controls to provide a uniform product. The machine is designed to operate with almost any type of commercial soft-serve or non-dairy mixes available, including ice milk, ice cream, yogurt, and frozen dietary desserts.

This manual is designed to assist qualified personnel and operators in the installation, operation and maintenance of the Stoelting Model F431 pressure machine.



**Figure 1-1 Model F431 Machine**

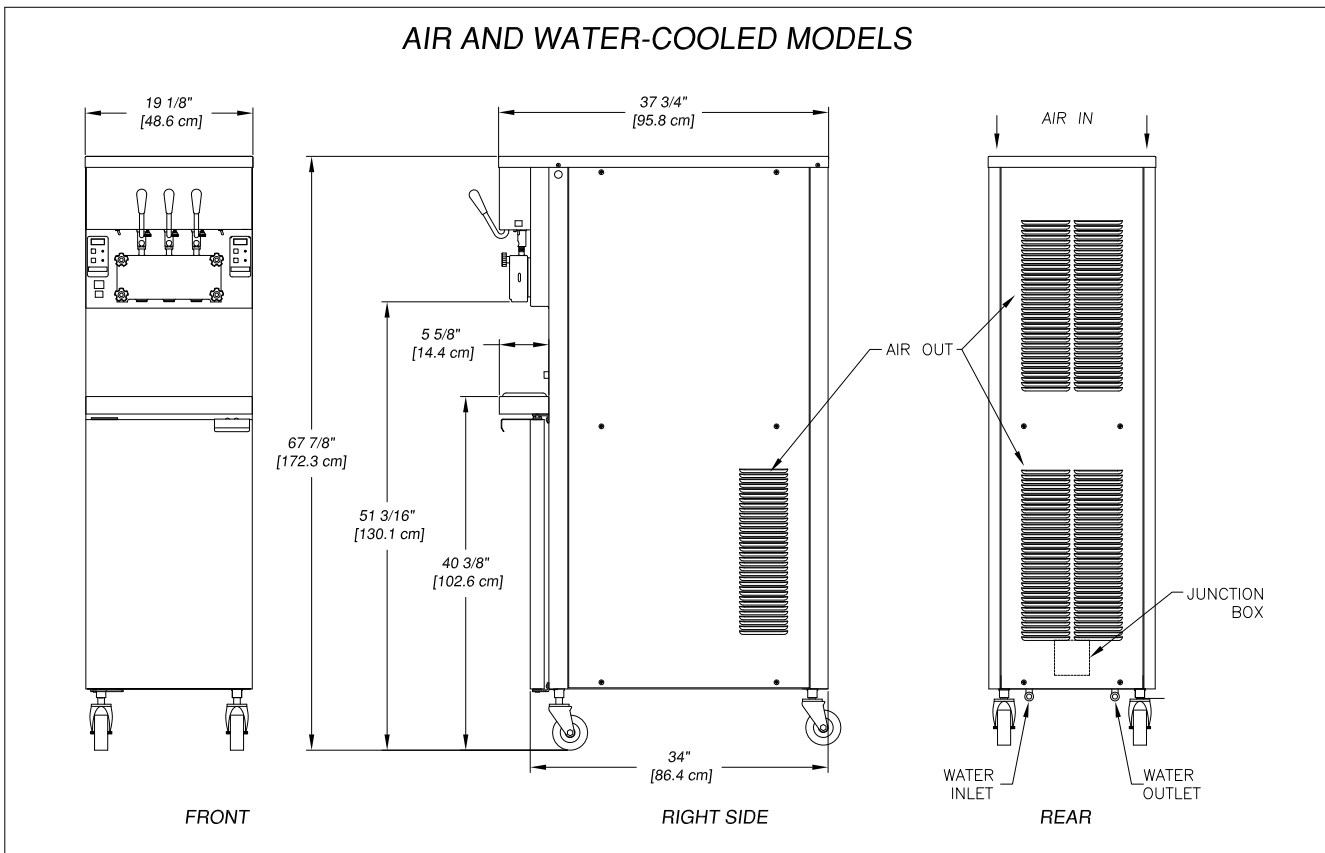

## 1.2 SPECIFICATIONS

<b>Model F431</b>													
<b>Dimensions</b>	<table style="width: 100%; border-collapse: collapse;"> <thead> <tr> <th style="width: 30%;"></th> <th style="width: 35%; text-align: center;"><b>Machine</b></th> <th style="width: 35%; text-align: center;"><b>with crate</b></th> </tr> </thead> <tbody> <tr> <td style="padding-left: 20px;">width</td> <td style="text-align: center;">19-1/8" (48,6 cm)</td> <td style="text-align: center;">27" (68,6 cm)</td> </tr> <tr> <td style="padding-left: 20px;">height</td> <td style="text-align: center;">67-7/8" (172,4 cm)</td> <td style="text-align: center;">78" (198,1 cm)</td> </tr> <tr> <td style="padding-left: 20px;">depth</td> <td style="text-align: center;">37-3/4" (95,9 cm)</td> <td style="text-align: center;">48" (121,9 cm)</td> </tr> </tbody> </table>		<b>Machine</b>	<b>with crate</b>	width	19-1/8" (48,6 cm)	27" (68,6 cm)	height	67-7/8" (172,4 cm)	78" (198,1 cm)	depth	37-3/4" (95,9 cm)	48" (121,9 cm)
	<b>Machine</b>	<b>with crate</b>											
width	19-1/8" (48,6 cm)	27" (68,6 cm)											
height	67-7/8" (172,4 cm)	78" (198,1 cm)											
depth	37-3/4" (95,9 cm)	48" (121,9 cm)											
<b>Weight</b>	<table style="width: 100%; border-collapse: collapse;"> <tbody> <tr> <td style="width: 30%;"></td> <td style="width: 35%; text-align: center;">500 lbs (226,7 kg)</td> <td style="width: 35%; text-align: center;">650 lbs (294,8 kg)</td> </tr> </tbody> </table>		500 lbs (226,7 kg)	650 lbs (294,8 kg)									
	500 lbs (226,7 kg)	650 lbs (294,8 kg)											
<b>Electrical</b>	<b>1 Phase, 208-240 VAC, 60Hz</b>												
circuit ampacity	24A minimum												
overcurrent protection device	30A maximum												
International Option	1 Phase, 220-240 VAC, 50Hz												
<b>Compressor</b>	11,000 Btu/hr Scroll™ Compressor												
<b>Drive Motor</b>	Two - 3/4 hp												
<b>Air Flow</b>	Air cooled units require 3" (7,6 cm) air space on both sides, 6" back.												
<b>Plumbing Fittings</b>	Water cooled units require 1/2" N.P.T. water and drain fittings.												
<b>Hopper Volume</b>	Two - 5.5 gallons (20,82 liters)												
<b>Freezing Cylinder Volume</b>	Two - 0.85 gallon (3,22 liters)												



## SECTION 2 INSTALLATION INSTRUCTIONS

### 2.1 SAFETY PRECAUTIONS

Do not attempt to operate the machine until the safety precautions and operating instructions in the manual are read completely and are thoroughly understood.

Take notice of all warning labels on the machine (see Figure 2-1). The labels have been put there to help you maintain a safe working environment. The labels have been designed to withstand washing and cleaning. All labels must remain legible for the life of the machine. Labels should be checked periodically to be sure they have not been painted over, rubbed off, fallen off, and can be recognized as warning labels.

If you are in need of replacement labels, indicate the part number, type of label, location of label, and quantity required along with your name and address and mail to:

**Stoelting, LLC**  
**Commercial Products**  
**502 Hwy. 67**  
**Kiel, WI 53042**

### 2.2 SHIPMENT AND TRANSIT

The machine has been assembled, operated, and inspected at the factory. Upon arrival at the final destination, the machine must be checked for any damage which may have occurred during final transit.

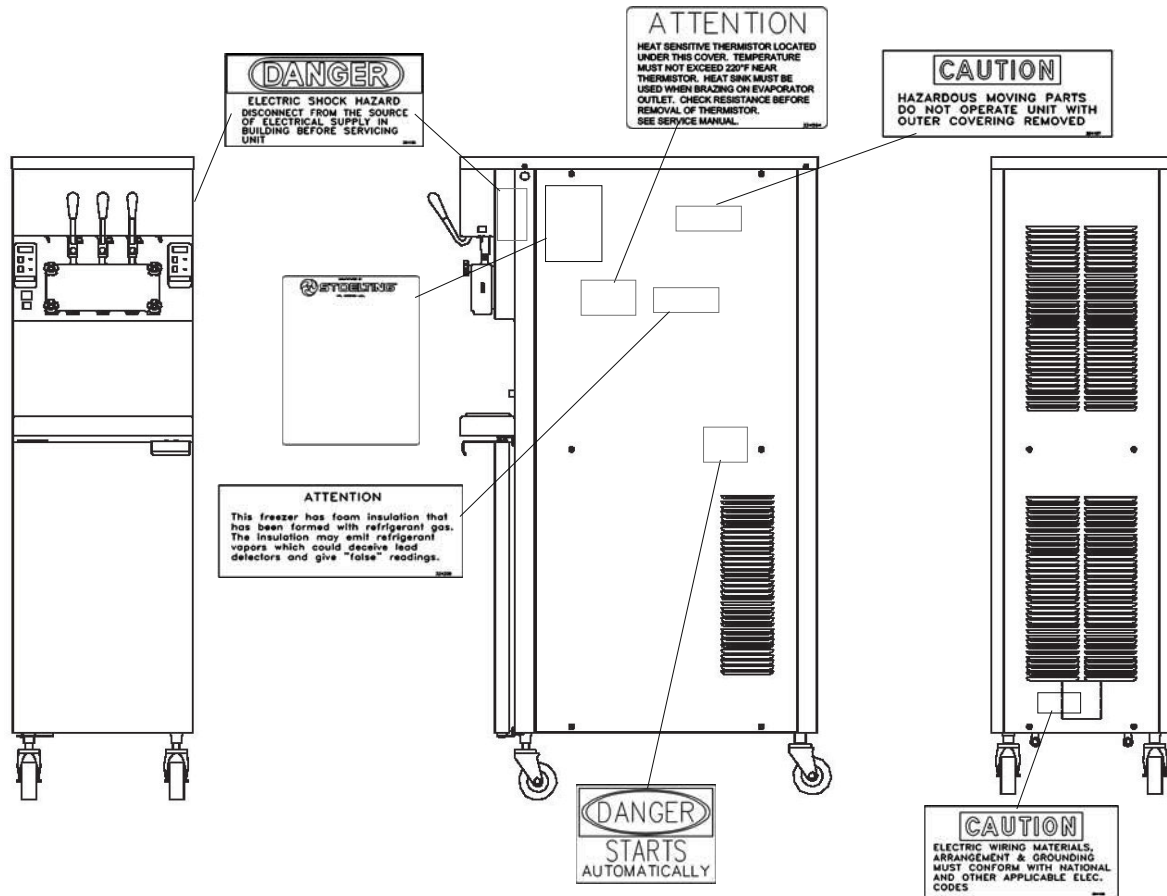

Figure 2-1 Warning Label Locations

ITEM	STOELTING PN	QTY		DESCRIPTION
		-03	-04	
1	324801	2	2	DECAL - MIX LOW
2	324798	2	2	DECAL CLEAN-OFF-SERVE SWITCH
3	324141	1	1	DECAL CAUTION-ROTATING BLADES
4	723526	1	1	TAG READ MANUAL & ALL DECALS
5	324346	3	3	DECAL HAZARDOUS MOVING PARTS
6	324393	1	1	DECAL STOELTING SWIRL LOGO
7	324800	1	1	DECAL - CAB ON/OFF
8	324799	2	2	PUMP ON/OFF
9	324208	2	2	DECAL REFRIG LEAK CHECK
10	324509	1	1	DECAL CLEANING (SS & SHAKE)
11	324103	2	2	DECAL CAUTION-ROTATING SHAFT
12	324686	4	4	DECAL DANGER AUTOMATIC START
13	324107	2	2	DECAL CAUTION MOVING PARTS
14	324125	7	7	DECAL ELECT SHOCK HAZARD
15	324151	2	2	DECAL FIELD CONNECTIONS
16	324198	-	2	DECAL ATTENTION INSTALLER
17	130000	2	2	BAG, ENVELOPE FRONT LOADING
18	324584	1	1	DECAL, ADEQUATE VENTILATION (3")
19	324158	2	2	DECAL COPPER CONDUCTORS ONLY
20	324106	2	2	DECAL CAUTION WIRING MAT'L
21	324107	4	4	DECAL CAUTION MOVING PARTS
22	324566	2	2	DECAL - WIRED ACCORDING TO
23	324015	-	2	DECAL 2X1-1/4 BLK ON WHITE
24	723552	2	2	TAG, CAUTION - SUPPLY VOLTAGE
26	324804	1	1	DECAL - GM HEADER (STOELTING SWIRL)
26	324803	1	1	DECAL - GM HEADER (STOELTING LOGO)
26	324806	1	1	DECAL, A&W HEADER FOR U431 & 4231
27	324346	2	2	DECAL-CAUTION HAZARDOUS MOVING
28	324797	2	2	DECAL, STANDBY/SERVE SWITCH
29	324242	1	1	DECAL, TEMPERATURE CONTROL
30	324200	2	2	DECAL, MANUAL RESET
31	.	.	.	.
32	324014	2	2	DECAL, ARROW
33	314796	2	2	DECAL, FREEZING

With the method of packaging used, the equipment should arrive in excellent condition. THE CARRIER IS RESPONSIBLE FOR ALL DAMAGE IN TRANSIT, WHETHER VISIBLE OR CONCEALED. Do not pay the freight bill until the machine has been checked for damage. Have the carrier note any visible damage on the freight bill. If concealed damage and/or shortage is found later advise the carrier within ten days and request inspection. The customer must place claim for damage and/or shortages in shipment with the carrier. Stoelting, LLC cannot make any claims against the carrier.

### 2.3 MACHINE INSTALLATION

Installation of the machine involves moving the machine close to its permanent location, removing all crating, setting in place, assembling parts, and cleaning.

- A. Uncrate the machine.

 <b>WARNING</b>
<p>Installation must be performed by a qualified electrician/refrigeration specialist. Incorrect installation may cause personal injury, severe damage to the machine and will void factory warranties.</p>

- B. Install the four casters. Turn the threaded end into the machine until zero threads are showing. To level, turn out casters no more than 1/4" maximum, then tighten all jam nuts.
- C. The machine must be placed in a solid level position.

#### NOTE

*Accurate leveling is necessary for correct drainage of machine barrel and to insure correct overrun.*

- D. Machines with air cooled condensers require a minimum of 3" (7,5cm) of space on all sides and 10" (25cm) at the top for proper circulation. A minimum of 6" (15cm) side clearance is required in high ambient conditions (>98°F).
- E. Soft serve machines with water cooled condensers require 1/2" NPT supply and drain fittings.

### 2.4 INSTALLING PERMANENT WIRING

<b>CAUTION</b>
<p><b>Risk of product damage</b> Air cooled condenser requires proper ventilation. Failure to provide adequate ventilation will void factory warranties.</p>

If permanent wiring is required by local codes, the following procedure must be performed:

- A. Refer to the nameplate on the side panel of the machine for specific electrical requirements. Make sure the power source in the building matches the nameplate requirements.

 <b>WARNING</b>
<p><b>Hazardous voltage</b> High voltage will shock, burn or cause death. Turn off and lock out main power disconnect before installing wiring. Do not operate machine with cabinet panels removed.</p>

- B. Remove the back panel and the junction box cover located at the bottom of the machine.
- C. Install permanent wiring according to local code.
- D. Check the auger shaft rotation by placing the Main Freezer Power Switch in the ON position, placing both Freezing Cylinder OFF/ON switches in the ON position and pressing the CLEAN button on each of the control panels. Auger shaft rotation is clockwise as viewed through the clear plastic front door (see Figure 2-2).
- E. Press the CLEAN button to stop the augers.

### 2.5 MIX PUMP

#### A. MIX PUMP HOSE INSTALLATION

Follow the steps below to install the mix pump hose in the cabinet part of the machine.

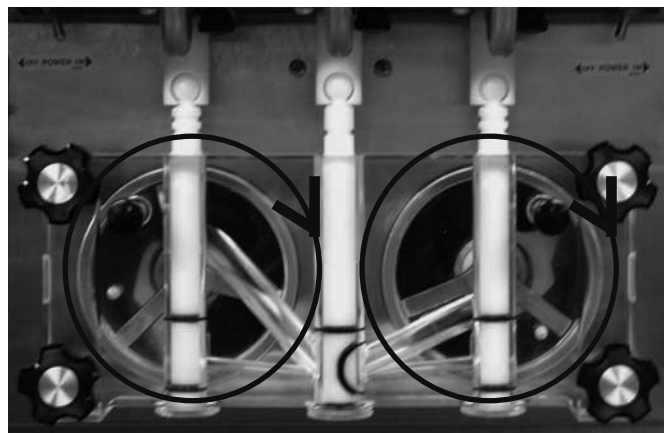

**Figure 2-2 Auger Rotation**

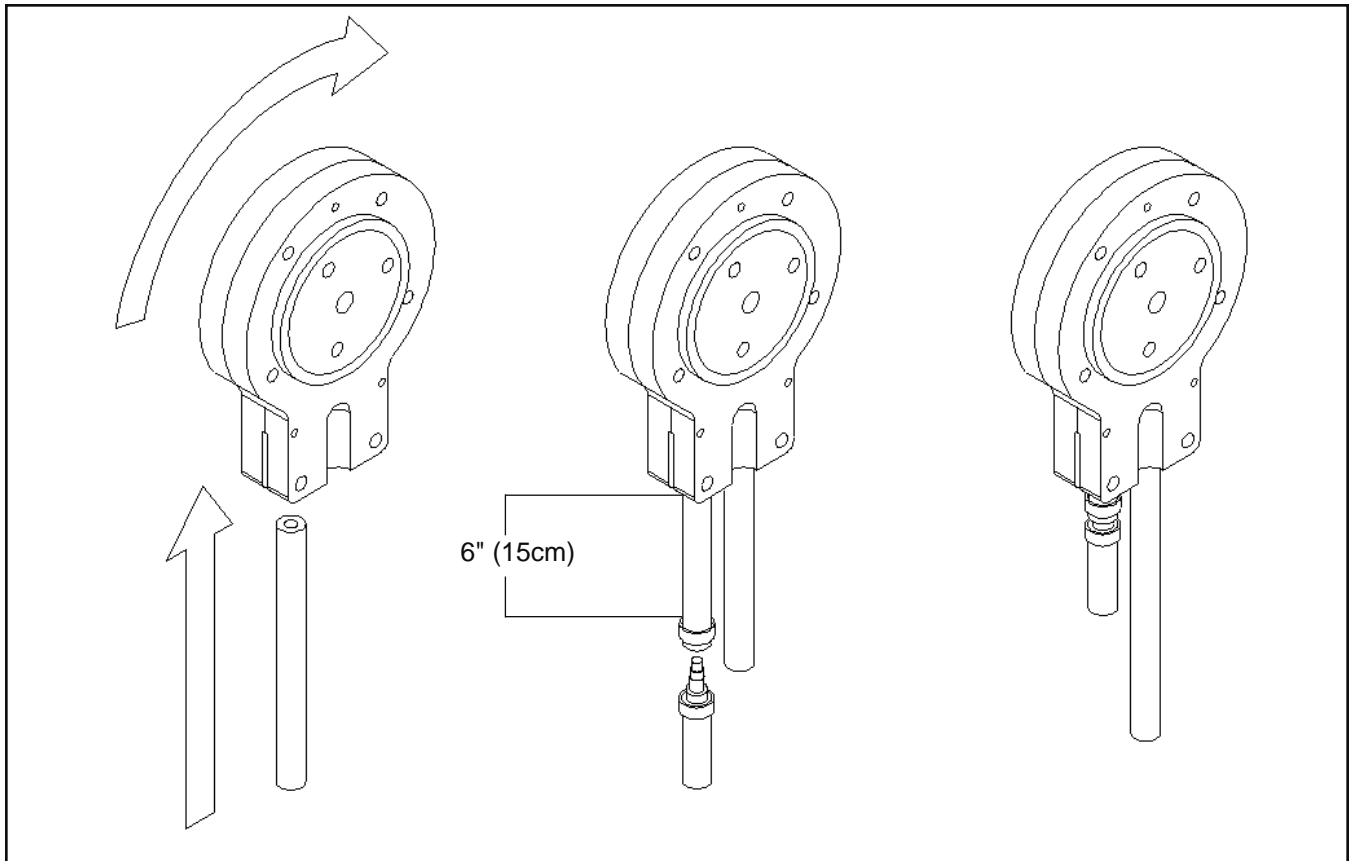

**Figure 2-3 Mix Hose Installation**

1. Turn pump on.
2. Feed one end of mix pump hose into the entering or pickup hose side (left) of black cover.

**NOTE**

*Feed the tube into the clamp so the natural curve of the tube is towards the outside of the black cover. This prevents the hose from looping around the black cover twice.*

3. Gently push the hose into the black cover until it begins to feed.
4. Allow the hose to feed itself through the pump until 6" (15cm) remains on the entering side.
5. Turn pump off.
6. Connect mix pump hose to the elbow fitting (located on the left side of the mix line manifold) using small hose clamp. Be careful not to twist the mix hose.
7. Turn pump on.
8. Allow remaining 6" (15cm) of tubing to feed through pump until hose adapter prevents further feeding.
9. Turn pump off.
10. Connect free end of mix pump hose to 3-way Tee as shown in Figure 2-4. When all connections are complete the 3-way Tee must be lower than the black pump housing.

<b>CAUTION</b>
<p><b>Risk of product damage</b></p> <p>Air/mix Tee must remain below the black cover/clamp. If Tee is above the pump, mix will drain to the air compressor resulting in pump damage.</p>

**B. MIX PICKUP HOSE INSTALLATION**

The F431 machine may be connected to standard mix containers or prepacked mix bags. One, 5 gallon mix bag may be connected to each freezing cylinder or two 2-1/2 gallon bags may be connected on each side. Follow the instructions below that match your configuration.

**When Using One Mix Container Per Side:**

1. Connect a 2" (5cm) length of 3/8" (9,5mm) ID plastic food grade tubing to the mix pickup assembly. Secure with hose clamps. Then place assembly through hole in cover and install retaining clip (see Figure 2-4 and 2-5).
2. Connect the free end of tubing to the mix check valve. Observe direction of check valve flow arrow. Secure with hose clamp. Connect 24" (61cm) length of 3/8" (9,5mm) ID plastic food grade tubing to free end of check valve and secure with hose clamp.

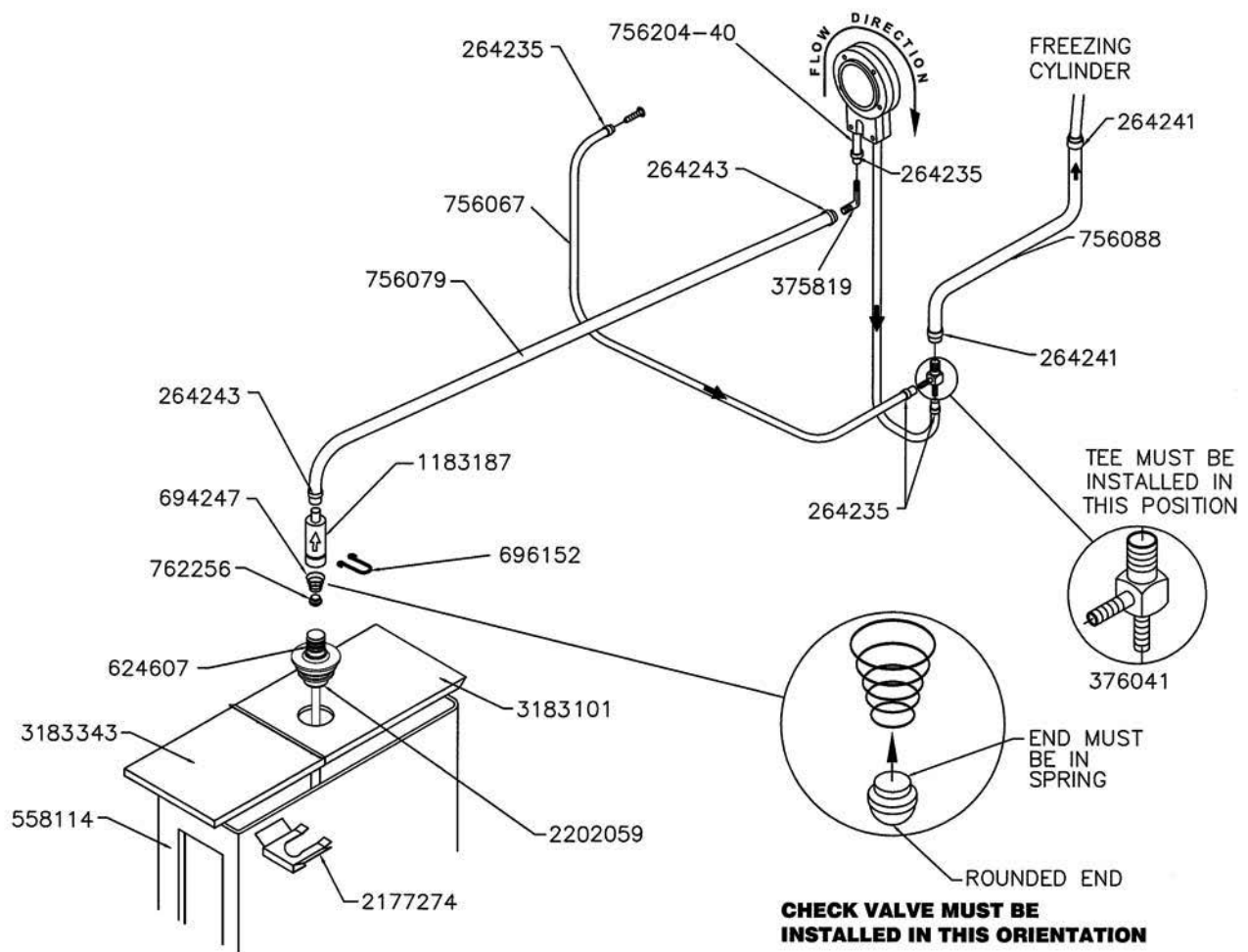

**Figure 2-4 Mix Pump Connections for Standard Mix Container**

3. Connect elbow fitting to free end of tubing. Connect opposite end of elbow to 1/4" ID tan tubing on the left side of pump head. Secure with hose clamps (see Figure 2-3 and 2-4).

**When Using Bag Connection System (BCS) with Two Bags Per Side (optional kit #2183189):**

1. Connect 3/8" (9,5mm) ID plastic food grade tubing to a bag adapter. Secure with hose clamps. This bag adapter will connect to the bag nearest the front of the machine.
2. Slide the hose clip over free end of 3/8" (9,5mm) ID plastic food grade tubing. Attach free end of tubing to a manifold adapter. Secure with large hose clamp or equivalent. Push the manifold adapter into the left port of the mix inlet manifold and secure with retaining clip. (See Figure 2-7).
3. Connect 3/8" (9,5mm) ID plastic food grade tubing to a bag adapter. Secure with hose clamps. This bag adapter will connect to the bag nearest the back of the machine.



**Figure 2-5 Connecting Mix Pick-up Assembly**



**Figure 2-6 Connecting Pump Hose to BCS Manifold**



**Figure 2-7 Completed BCS Hose Assembly**

4. Attach free end of tubing to a manifold adapter. Secure with large hose clamp or equivalent. Push the manifold adapter into the right port of the mix inlet manifold and secure with retaining clip. (See Figure 2-7).
5. Place two mix bags into each mix container as shown in Figure 2-8 (left mix container shows two bag configuration).
6. Connect the bag adapter attached to the left side of the manifold to the mix bag in the front of the mix container (nearest the cabinet door). Connect the bag adapter attached to the right side of the manifold to the mix bag in the back of the mix container (see Figure 2-8).

**When Using Bag Connection System (BCS) with One Bag Per Side (optional kit):**

1. Connect 3/8" (9,5mm) ID plastic food grade tubing to a bag adapter. Secure with hose clamps.
2. Connect free end of 3/8" (9,5mm) ID plastic food grade tubing to mix check valve. Observe direction of check valve flow arrow. Secure with hose clamp. Connect 3/8" (9,5mm) ID plastic food grade tubing to free end of check valve and secure with hose clamp.
3. Connect elbow fitting to free end of tubing. Connect opposite end of elbow to 1/4" ID tan tubing on the left side of pump head. Secure with hose clamps (see Figure 2-3 and 2-4).

4. Place one mix bag into each mix container as shown in Figure 2-8 (right mix container shows one bag configuration).
5. Connect the bag adapter to the mix bag. (See Figure 2-8).



**Figure 2-8 Connecting BCS Mix Bags (two bag connection on left, one bag connection on right)**

**When Using Two Mix Containers or Bag Connection Systems (BCS) on one Side (optional kit #2183189):**

1. The F431 can be configured to operate with only one freezing cylinder turned on. This may be done if only one flavor is being dispensed during slow times. In this case, running only one freezing cylinder will help minimize product breakdown, while reducing mix container filling or mix bag replacement.
2. Connect two mix containers or two mix bags as described above, but connect both containers to the mix line manifold of the freezing cylinder you will be using.

**C. MIX LOW LEVEL INDICATOR ADJUSTMENT**

The sensitivity of the “Mix Low” indication that displays on the control panel can be adjusted to operator preference. If more advanced notice of low mix is required, simply loosen the black adjustment knobs located on the sensor brackets at the back of the machine cabinet, and slide the bracket upwards. If the “Mix Low” message appears while there is still sufficient mix in the container, slide the bracket downward. Be sure to tighten the adjustment knobs after properly positioning the sensor (see Figure 2-6).

## SECTION 3 INITIAL SET-UP AND OPERATION

### 3.1 SAFETY PRECAUTIONS

SAFE OPERATION IS NO ACCIDENT; observe these rules:

- A. Know the machine. Read and understand the operating instructions.
- B. Notice all warning labels on the machine.
- C. Wear proper clothing. Avoid loose fitting garments, and remove watches, rings or jewelry which could cause a serious accident.
- D. Maintain a clean work area. Avoid accidents by cleaning the area and keeping it clean.
- E. Stay alert at all times. Know which switch, push button or control you are about to use and what effect it is going to have.
- F. Disconnect electrical power for maintenance. Never attempt to repair or perform maintenance on the machine until the main electrical power has been disconnected.
- G. Do not operate under unsafe operating conditions. Never operate this machine if unusual or excessive noise or vibration occurs.

### 3.2 OPERATING CONTROLS AND INDICATORS

Before operating the machine, it is required that the operator know the function of each operating control. Refer to Figure 3-1 for the location of the operating controls on the machine. For the information regarding error codes displayed on the control panel, refer to the troubleshooting section of this manual.

#### WARNING

##### **Hazardous voltage**

The Main Freezer Power switch must be placed in the OFF position when disassembling for cleaning or servicing. The machine must be disconnected from electrical supply before removing any access panel. Failure to disconnect power before servicing could result in death or serious injury.

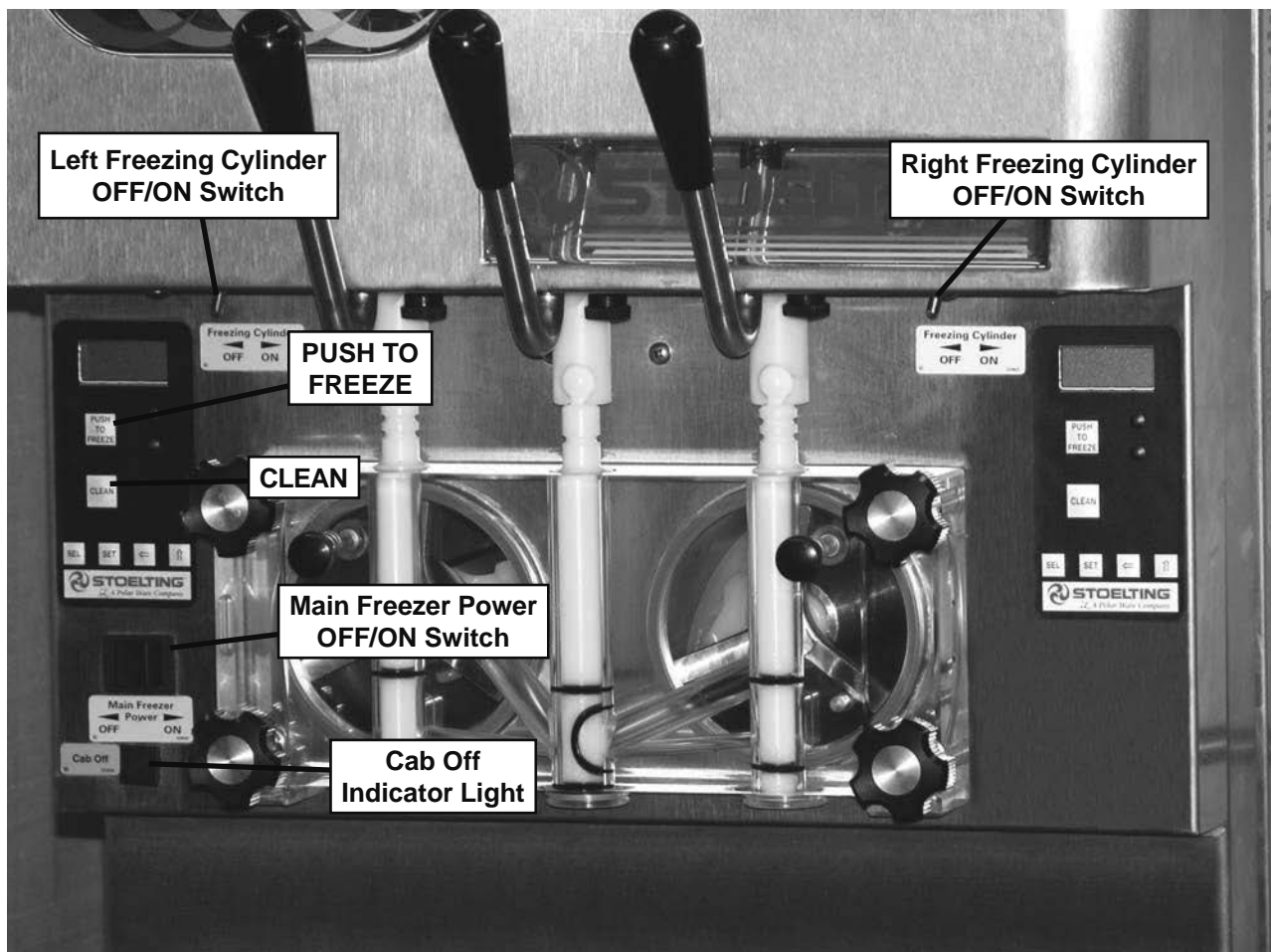

Figure 3-1 Controls

### A. Main Freezer Power Switch

The Main Freezer Power switch is a two position rocker switch that supplies power to the IntelliTec control, freezing cylinder circuits and lower cabinet refrigeration system. When the switch is placed in the ON position, the lower cabinet refrigeration system will run until the preset temperature is reached; then cycle ON and OFF to maintain that temperature. Power to individual freezing cylinders can then be controlled with the Freezing Cylinder OFF/ON switches.

### B. Freezing Cylinder OFF/ON Switch

The Freezing Cylinder OFF/ON switches are two position toggle switches used to supply power to the left or right freezing cylinder control circuit. When the switch is in the OFF position, the refrigeration system and auger will not operate. When the switch is in the ON position, the machine will be operational.

### C. Spigot Switch

The spigot switch is mounted to the spigot cam assembly behind the header panel. When the spigot is opened to dispense product, the spigot switch opens and the "Serve Mode" begins.

### D. Cab Off Indicator Light

A flashing light indicates the Main Freezer Power Switch is in the OFF position; no refrigeration is being supplied to the cab. Place the Main Freezer Power switch in the ON position for cab refrigeration.

### E. Pump Switch

The pump motor switches are the two rocker switches located in the upper left-hand side of the refrigerated cab. When a switch is placed in the OFF position, the pump will not run. When the switch is placed in the ON position, the pump will run until the preset pressure is reached, then cycle on and off as product is drawn to maintain that pressure.

### F. Push To Freeze Button

The PUSH TO FREEZE button is a membrane or "snap" switch used to initiate "Serve Mode".

#### NOTE

*After the PUSH TO FREEZE button is pressed, the drive motor starts. After a 3-second delay, the compressor will start.*

### G. LEDs

The membrane switch (touchpad) features two lights; a green LED and an amber LED. The green LED is lit during "Serve Mode". During freeze down, it is not lit. When product consistency approaches 75% in the freezing cylinder, the green LED flashes. The amber LED is on during all other modes. In the event of an error or when the freezing cylinder is off, both LEDs alternatively flash.

### H. Clean Button

The CLEAN button is a membrane, or "snap" switch. When the button is pressed, the freezing cycle stops and the drive motor will start. A CLEAN message will display on the LCD screen along with a 5-minute countdown timer. If the button is pressed again, the timer will reset. To exit the CLEAN mode, turn the Freezing Cylinder OFF/ON switch to the OFF position. If the machine is left in CLEAN for more than 20 minutes, an error code (E4) will be displayed on the display panel. Place the Freezing Cylinder OFF/ON switch in the OFF position and back in the ON position to clear this error.

### I. Mix Low Light Indicator

A MIX LOW message will appear on the LCD display to alert the operator of a low mix condition. The message will display when there is approximately one gallon of mix left in the mix container or when one bag of the Bag Connection System (BCS) is empty. When the MIX LOW message is displayed, refill container or replace bag immediately.

### J. Dispense Rate Adjusters

The dispense rate adjuster limits the opening of the spigot. To adjust product dispense rate, turn the adjusting knob clockwise for slower flow and counterclockwise for faster flow. It takes at least five complete turns of the adjusting knob to make a noticeable difference in the dispense rate.

### K. High Head Pressure Cutout

If the head pressure exceeds 445 psig (28 bar), the high head pressure cutout will trip. It will automatically reset after about 10-15 minutes.

### L. Front Door Safety Switch

The front door safety switch prevents the auger from turning when the front door is removed. The switch is open when the door is removed and closed when the door is properly installed.

### M. Menu Navigation Buttons

The Menu Navigation Buttons allow the user to display information regarding the machine's status of operation as well as adjust product consistency (Fig. 3-2).



Figure 3-2 IntelliTec Control



**Selection Button (SEL)** The SEL button is used in combination with the up arrow to enter into the settings of the IntelliTec control. This button is also used to navigate through the control settings menu.

**Set Button (SET)** During normal operation the SET button is used to save a change made to the product consistency setting. It is also used to save changes when modifying control settings.

**Left Arrow Button (←)** During normal operation, if the left arrow button is pressed for 5 seconds, the display will remain lit. To turn the light off, press the left arrow button for 5 seconds. The left arrow button is used primarily to navigate through the control settings.

**Up Arrow Button (↑)** Under normal operation, after pressing the SET button, the up arrow button will change the value of the product consistency setting. This button is used primarily to navigate through the control settings.

### 3.3 IMPORTANT INFORMATION REGARDING CLEANING AND SANITIZING

Soft serve and shake machines require special consideration when it comes to food safety and proper cleaning and sanitizing.

The following information specifically covers issues for cleaning and sanitizing frozen dessert machines. This information is meant to supplement a comprehensive food safety program.

**Soil Materials Associated with Frozen Dessert Machines**

**MILKFAT/BUTTERFAT** – As components of ice-cream/frozen custard mix, these soils will accumulate on the interior surfaces of the machine and its parts. Fats are difficult to remove and help attribute to milkstone buildup.

**MILKSTONE** – Is a white/gray film that forms on equipment and utensils that come in contact with dairy products. These films will accumulate slowly on surfaces because of ineffective cleaning, use of hard water, or both. Milkstone is usually a porous deposit, which will harbor microbial contaminants and eventually defy sanitizing efforts.

Once milkstone has formed, it is very difficult to remove. Without using the correct product and procedure, it is nearly impossible to remove a thick layer of milkstone.

(NOTE: general-purpose cleaners DO NOT remove milkstone.) This can lead to high bacteria counts and a food safety dilemma.

**IT IS BEST TO CONTROL MILKSTONE ON A DAILY BASIS BEFORE IT CAN BECOME A SIGNIFICANT FOOD SAFETY PROBLEM.**

In addition to food safety, milkstone can cause premature wear to machine parts which can add to costs for replacement parts or possibly more expensive repairs if worn machine parts are not replaced once they have become excessively worn.

### Important Differences Between Cleaning and Sanitizing CLEANING vs. SANITIZING

It is important to distinguish between cleaning and sanitizing. Although these terms may sound synonymous, they are not. BOTH are required for adequate food safety and proper machine maintenance.

#### CLEANING

- Is the removal of soil materials from a surface.
- Is a prerequisite for effective sanitizing.

#### NOTE

*An UNCLEAN surface will harbor bacteria that can defy sanitizing efforts.*

Bacteria can develop and resist sanitizing efforts within a layer of soil material (milkstone). Thorough cleaning procedures that involve milkstone removal are critical for operators of frozen dessert machines.

#### SANITIZING

- Kills bacteria.
- Can be effective on clean surfaces only.

#### NOTE

*Using a SANITIZER on an unclean surface will not guarantee a clean and safe frozen dessert machine.*

Proper Daily Maintenance:

The Only Way to Assure Food Safety and Product Quality

Proper daily maintenance can involve a wide variety of products and procedures. Overall, the products and procedures fall into three separate categories. (Please note that this is a brief overview intended for informational purposes only.)

1. **CLEANING** – This involves draining mix from the machine barrel and rinsing the machine with water. Next, a cleaner is run through the machine. Then, the machine is disassembled and removable parts are taken to the sink for cleaning.
2. **MILKSTONE REMOVAL** – Since almost all cleaners do not have the ability to remove milkstone, the use of a delimer becomes necessary. Although this procedure may not be needed on a daily basis, it will usually follow the cleaning procedure. It requires letting a delimer solution soak in the machine for an extended period of time. Individual parts are also soaked in a deliming solution for an extended period of time (more about delimers in Additional Information).
3. **SANITIZING** – After the machine has been cleaned and contains no milkstone, the machine is reassembled. Then a FDA-approved sanitizing solution is run through the machine to kill bacteria. The machine is then ready for food preparation.

As a recommended cleaner and sanitizer for your frozen dessert machine, STERA-SHEEN has proven to be one of the best daily maintenance products for:

- **CLEANING** – Thorough removal of all solids including butterfat and milk fat.
- **MILKSTONE REMOVAL** – Complete removal of milkstone.
- **SANITIZING** – FDA-approved no rinse sanitizer for food contact surfaces.

#### Additional Information

#### THE USE OF DELIMERS

A delimer is a strong acid that has the ability to dissolve milkstone. This type of chemical may become necessary once high levels of milkstone have developed. While these products are very effective for removing HIGH levels of milkstone, they are not ideal for two reasons:

1. **PRODUCT SAFETY** – Strong acids are dangerous chemicals. Carefully follow safety instructions provided with delimer products.
2. **MACHINE DAMAGE** – Strong acids will attack metal and rubber causing premature wear of parts. The use of a delimer needs to be closely monitored to avoid damage to machine surfaces and parts.

With proper daily use of STERA-SHEEN or it's equivalent, there is no need for the use of a DELIMER.

#### DO NOT USE BLEACH

- **BLEACH HAS ABSOLUTELY NO CLEANING PROPERTIES.**
- **BLEACH IS CORROSIVE.** It can and will damage components of the machine causing premature wear and metal corrosion.

#### GENERAL PURPOSE CLEANERS

General purpose cleaners do not have the ability to remove milkstone. Milkstone will become a problem if not remedied with additional products and procedures.

#### THE USE OF CHLORINE TEST STRIPS

“Test strips” are used to determine concentrations of active chlorine in sanitizing solutions. To use the strips, tear off a small portion and submerge it into the sanitizing solution. Then, compare the color change to the color key on the side of the test strip dispenser to determine the approximate chlorine concentration.

### **WARNING**

Moving machinery can grab, mangle and dismember. Place the Main Freezer Power OFF/ON switch in the OFF position before disassembling for cleaning or servicing. Placing the Main Freezer Power OFF/ON switch in the ON position during cleaning or servicing may result in serious personal injury.

The ideal concentration of chlorine needs to be 100 ppm (as stated by the FDA).

#### NOTE

*Follow the directions on the container for proper concentration.*

There are two main factors that contribute to falling chlorine concentrations in a sanitizing solution.

1. **PRODUCT USE** – As the chlorine in the solution is being used, chlorine concentrations fall.
2. **TIME** – As time passes, small amounts of chlorine “evaporate” from the solution. (That is why you can smell it.)

Sanitizing solutions should not be allowed to fall below 100 ppm chlorine. New solutions should be mixed once old solutions become ineffective.

### 3.4 DISASSEMBLY OF MACHINE PARTS

Before using the machine for the first time, complete machine disassembly, cleaning and sanitizing procedures will need to be followed. Routine cleaning intervals and procedures must comply with the local and state health codes. Inspection for worn or broken parts should be made at every disassembly of the machine. All worn or broken parts should be replaced to ensure safety to both the operator and the customer and to maintain good machine performance and a quality product. A normal wear part is the auger flight (see Figure 3-3). Auger flights need to be replaced before the wear line is no longer visible.

To disassemble the machine, refer to the following steps:

#### A. Disassembly Of Front Door

1. Remove the front door by turning off the circular knobs and then pulling the front door off the studs.
2. Remove the air bleed valve by unscrewing the knob while holding the valve stem from behind (Fig. 3-4). Remove the compression spring and push air bleed valve through the rear of the front door.

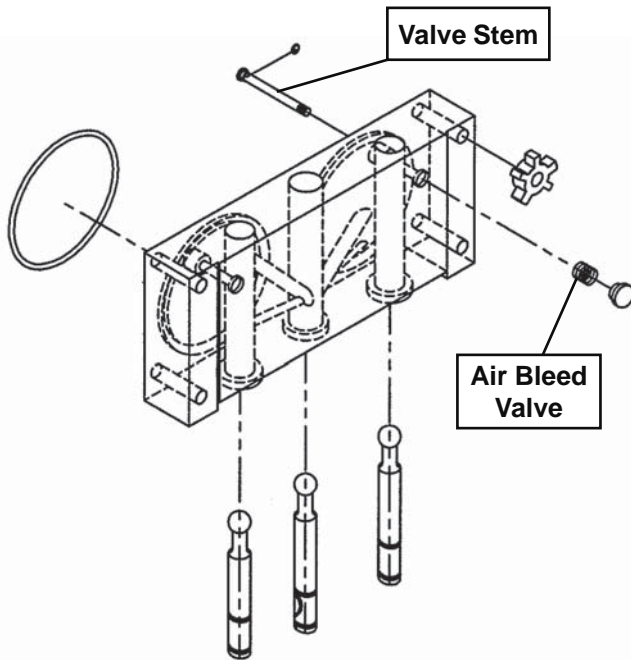

**Figure 3-3 Auger Flight Wear**

- Remove the spigots through the bottom of the front door. Remove all o-rings from spigots and air bleed valve.

### B. Disassembly Of Auger

- Remove the front auger support by pulling it straight out of the machine barrel.
- Remove the plastic bearing from the front auger support.



**Figure 3-4 Front Door Disassembly**

- Remove the auger by pulling slowly and rotating out of the machine barrel. As the auger is withdrawn, remove each plastic flight and spring from the auger (Fig. 3-5). Be careful not to scratch inside of machine barrel when removing flights or auger. Remove the spring from each auger flight.
- Keep the rear of the auger tipped up once it is clear of the machine barrel.
- Wipe spline lubricant off of the hex end of auger with a paper towel. Remove the rear seal assembly (Fig. 3-6).



**Figure 3-5 Auger Flight Removal**

### 3.5 CLEANING DISASSEMBLED PARTS

Disassembled machine parts require complete cleaning, sanitizing and air drying before assembling. Local and state health codes will dictate the procedure required. Some state health codes require a four sink process (pre-wash, wash, rinse, sanitize, air dry), while others require a three sink process (without the pre-wash step). The following procedures are a general guideline only. Consult your local and state health codes for procedures required in your location.

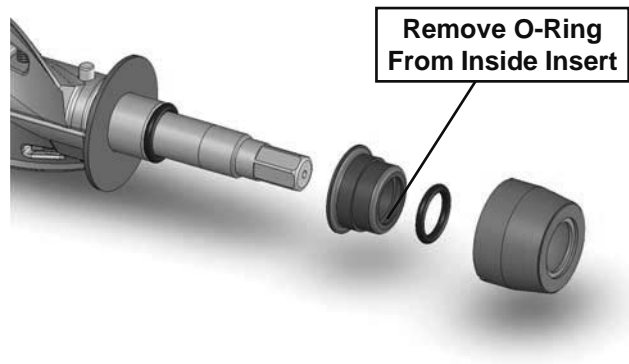

**Figure 3-6 Rear Seal Removal**

- To clean the machine parts disassemble all parts. (Refer to Section 3.4 for the disassembly of machine parts.)
- Place all front door and auger parts in clean 90° to 110°F (32°C to 43°C) water and wash thoroughly (four sink procedure only).
- Place all parts in 90° to 110°F (32°C to 43°C) , mild detergent water and wash thoroughly.
- Rinse all parts with clean 90° to 110°F (32°C to 43°C) water.
- Sanitize all machine parts following procedures outlined below.

### 3.6 SANITIZING MACHINE PARTS

- Use a sanitizer mixed according to manufacturer's instructions to provide a 100 parts per million strength solution. Mix sanitizer in quantities of no less than 2 gallons of 90° to 110°F (32°C to 43°C) water. Allow the sanitizer to contact the surfaces to be sanitized for 5 minutes. Any sanitizer must be used only in accordance with the manufacturer's instructions.
- Place all parts in the sanitizing solution for 5 minutes, then remove and let air dry completely before assembling in machine.

### 3.7 CLEANING THE MACHINE

The exterior should be kept clean at all times to preserve the lustre of the stainless steel. A high grade of stainless steel has been used on the machine to ease cleanup. To remove spilled or dried mix, simply wash the exterior with 90° to 110°F (32°C to 43°C), soapy water and wipe dry.

Do not use highly abrasive materials as they will mar the finish. A mild alkaline cleaner is recommended. Use a soft cloth or sponge to apply the cleaner. For best results, wipe in the direction of the grain of the steel.

- A. Clean the rear seal surface from inside of the machine barrel.
- B. Using this sanitizing solution and the large barrel brush provided, sanitize the barrel by dipping the

<b>CAUTION</b>
<b>Risk of Product Damage</b> Do no use acid cleaners, strong caustic compounds or abrasive materials to clean any part of the freezer exterior or plastic parts.

brush in the sanitizing solution and brushing the inside of the barrel.

- C. Remove the rear drip tray by pulling from side panel. Clean and replace drip tray.

### 3.8 ASSEMBLING MACHINE

To assemble the machine parts, refer to the following steps:

#### NOTICE

*Petrol-Gel sanitary lubricant or equivalent must be used when lubrication of machine parts is specified.*

#### NOTICE

*The United States Department of Agriculture and the Food and Drug Administration require that lubricants used on food processing equipment be certified for this use. Use Lubricants only in accordance with the manufacturer's instructions.*

- A. Assemble all o-rings onto parts dry, without lubrication. Then apply a thin film of sanitary lubrication to exposed surfaces of the o-rings.
- B. Lubricate rear seal area on auger shaft with a thin layer of sanitary lubricant. Install the rear seal o-ring. Lubricate outside of rear seal o-ring with sanitary lubricant.
- C. Install the stainless steel rear seal adapter into the rear seal dry (without lubricant). Lubricate the inside surface of the rear seal adapter, including the adapter o-ring, and install it onto the auger shaft. DO NOT lubricate the outside of the rear seal adapter (see Figure 3-7).

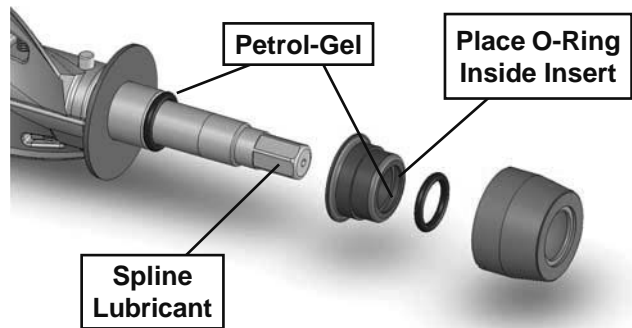

**Figure 3-7 Rear Seal Lubrication**

- D. Lubricate the hex drive end of auger with a small amount of spline lubricant. A small container of the lubricant is shipped with the machine.
- E. Screw the springs onto the studs in plastic flights. Spring must be screwed into the flights completely to provide proper tension (see Figure 3-8).
- F. Install the two plastic flights onto rear of the auger and insert part way into machine barrel.

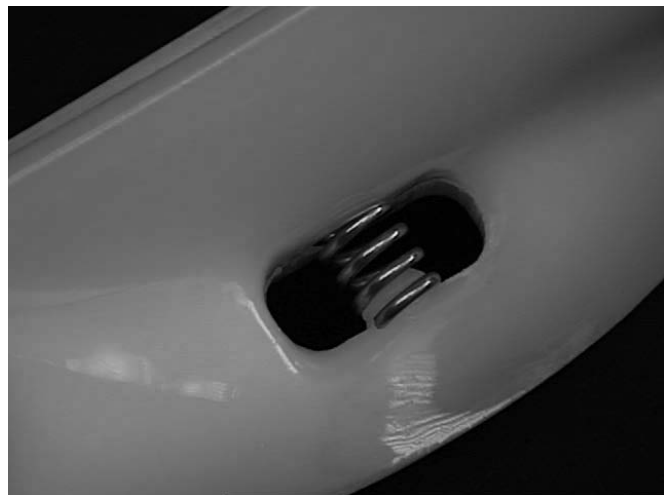
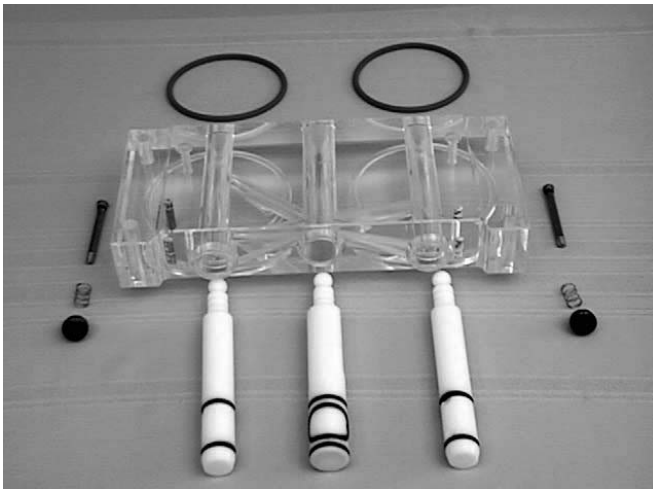

**Figure 3-8 Spring Installation**

- G. Install the remaining plastic flights, push the auger into the machine barrel and rotate slowly until the auger engages the drive shaft.
- H. Apply a thin film of sanitary lubricant to the inside and outside of the front auger support bearing, then place on the front of the auger. Assemble the front auger support onto the auger bearing.

#### NOTE

*Position the front support on auger so legs do not interfere with the pin on the back of the front door assembly. Front door must push auger in slightly when it is being tightened to prevent the rear seal from leaking.*



**Figure 3-9 Front Door Assembly**

- I. Install the spigots through the bottom of the front door (see Figure 3-9).
- J. Assemble the air bleed valve o-ring onto the air bleed valves. Position the o-ring in groove close to the wide part. Apply a thin film of sanitary lubricant to the o-rings.
- K. Insert the air bleed valves from the back of the front door. Install compression springs onto air bleed valves then screw knobs on finger tight.
- L. Apply a thin film of sanitary lubricant to the door seal o-rings, and fit into the grooves on the rear of the front door.
- M. Place the front door assembly on the mounting studs and push front door against the machine carefully.
- N. Secure front door assembly by placing the knobs on the studs and alternately tighten opposite corners until finger tight only. Do not overtighten. Proper o-ring seal can be observed through the transparent front door.

### 3.9 SANITIZING

Sanitizing must be done after the machine is clean and just before the machine is filled with mix. Sanitizing the night before is not effective. However, you should always clean the machine and parts after using it.

When sanitizing the machine, refer to local sanitary regulations for applicable codes and recommended sanitizing products and procedures. The frequency of sanitizing must comply with local health regulations. Mix sanitizer according to manufacturer's instructions to provide a 100 parts per million strength solution. Mix sanitizer in quantities of no less than 2 gallons of 90°F to 110°F (32°C to

<b>CAUTION</b>
<p><b>Risk of Product Damage</b>          Avoid prolonged contact of sanitizer with machine parts. Prolonged contact of sanitizer with machine may cause corrosion of stainless steel parts.</p>

43°C) water. Allow sanitizer to contact the surfaces to be sanitized for 5 minutes. Any sanitizer must be used only in accordance with the manufacturer's instructions.

- A. Prepare 3 gallons of sanitizing solution following manufacturer's instructions. Pour into clean container and place container into the cabinet.
- B. Place the mix pump switch in the ON position and open air bleed valve on the front door by pushing valve in and holding (see Figure 3-10).
- C. Let sanitizing solution fill the machine barrel to air bleed valve, then close the valve by pulling out to lock in place.

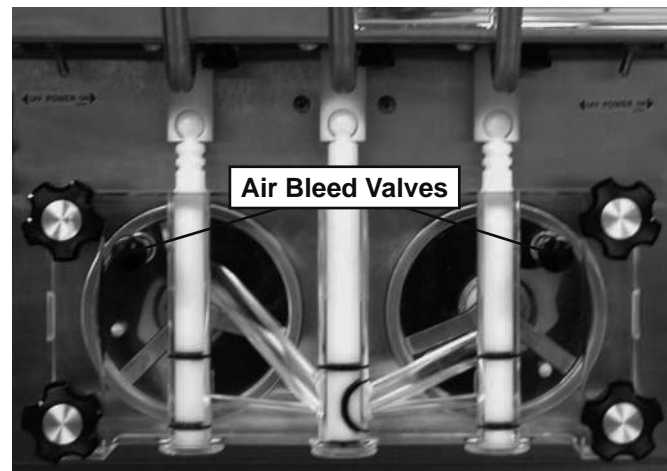

**Figure 3-10. Air Bleed Valves**

<b>! WARNING</b>
<p>The United States Department of Agriculture and the Food and Drug Administration require that all cleaning and sanitizing solutions used with food processing equipment be certified for this use.</p>

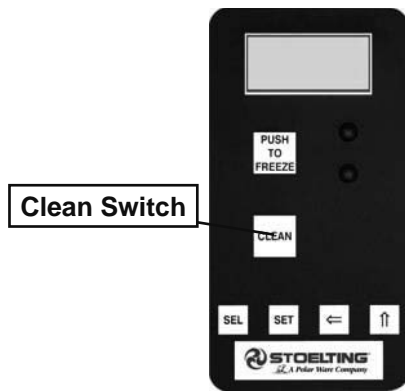

**Figure 3-11 Clean Control**

- D. Place the Main Power OFF/ON and Freezing Cylinder OFF/ON switches in the ON position then press the CLEAN button (Fig. 3-11).
- E. Check for leaks when the freezing cylinder is first pressurized with sanitizing solution.
  - 1. Check for leaks at the front door seals.
  - 2. Check the drain located above the center of the Drip Tray for leaks coming from the rear of the Rear Auger Seal.
  - 3. Check inside the cab unit for leaks at hose connections.
- F. Using a sanitized soft bristle brush or equivalent, dipped in sanitizing solution, clean mix container.
- G. After five minutes, open spigot to expel sanitizing solution. Drain all solution from machine using all three spigots.
- H. When solution has drained, press the CLEAN button to stop the auger and place the Main Power OFF/ON and Freezing Cylinder OFF/ON switches in the OFF position. Allow the machine barrel to drain completely.

The machine is now sanitized and ready for adding mix.

### 3.10 INITIAL FREEZE DOWN AND OPERATION

Every Stoelting soft serve machine needs to be set on site. The following adjustment will provide optimal product consistency while prolonging product life.

#### NOTE

*The machine is designed for correct operation in ambient temperatures between 50°F and 110°F. Temperatures out of that range may cause refrigeration problems and product quality issues.*

#### NOTE

*Do the initial adjustment for the left side and right side separately.*

### A. ADDING MIX

1. Sanitize immediately before use.
2. Make sure the Freezing Cylinder OFF/ON switch is in the OFF position.
3. Fill the storage containers in the cab with at least 2.5 gallons of mix.
4. Attach the mix inlet probes to the container and place the containers in the refrigerated cab.
5. Place the mix pump switch in the ON position (Fig. 3-12).

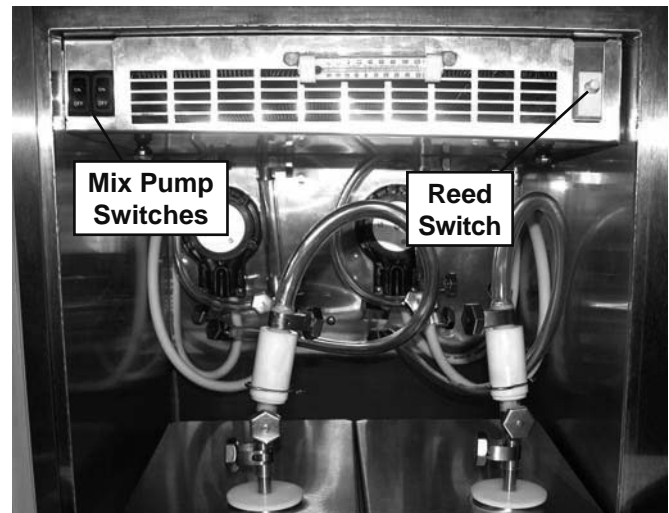

**Figure 3-12 Refrigerated Cabinet**

6. Place a container under the spigot and open the spigot to allow the mix to flush out about 8 ounces (0.23 liters) of sanitizing solution and liquid mix. Close the spigot.
7. Open the air bleed valve on the front door by pressing and holding (Fig. 3-13). Hold the valve open until the mix level in the freezing cylinder is 1/2" from the air bleed valve.

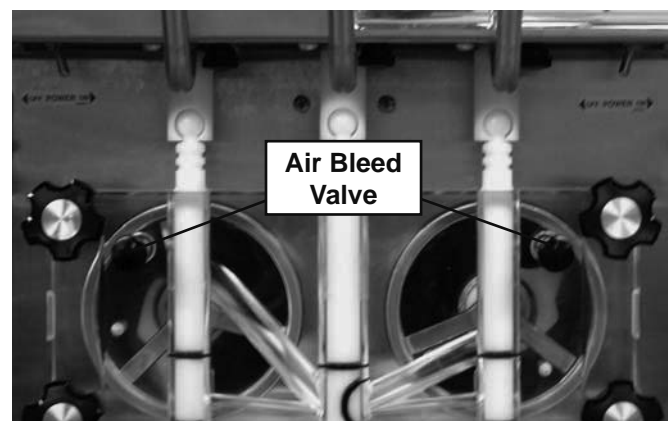

**Figure 3-13 Air Bleed Valves**

## B. PREPARING INTELLITEC CONTROL

8. On the IntelliTec control, press and hold SEL button for 8 seconds. While still holding the SEL button, press the up arrow (↑) button. The LCD will read "DISPLAY".
9. Press the left arrow (←) button once. The display will read "BASIC".
10. Press the up arrow (↑) button once. The display will read "CutOut amps".
11. Press the SET button. A cursor will start blinking under the far right digit.
12. Change the value to 8.0. Press the left arrow (←) button to move the cursor. Press the up arrow (↑) button to increase the digit. When a digit reaches 9, pressing the up arrow (↑) button again will change the value to 0.
13. After entering 8.0, press SET to save this value. The LCD will read "CutOut Set -- OK".
14. Press the SEL button. The LCD will read "CutOut amps 8.0".
15. Press the SEL button twice. The LCD will read "DISPLAY".
16. Press the up arrow (↑) button to navigate to the "°F" and "amps" readings.

## C. INITIAL FREEZE DOWN

17. Place the Freezing Cylinder OFF/ON switch in the ON position.
18. Press the PUSH TO FREEZE button.

### NOTE

*After the drive motor starts, there is a 3-second delay before the compressor starts.*

19. As the product freezes, the "amps" value on the display will increase. When it reaches 2.6A, open the spigot, take a 6-8 ounce sample and measure the temperature. For most soft serve mixes, the desired temperature is between 19.0°F and 19.5°F.
20. Draw samples at every increase of 0.2A until reaching the desired consistency and temperature.

### NOTE

*Show the sample to the customer and make sure it meets their required consistency and temperature.*

21. Record the "amps" value.
22. Place the Freezing Cylinder OFF/ON switch in the OFF position.

## D. ADJUSTING INTELLITEC CONTROL

23. Press the SEL button. The display will read "DISPLAY".
24. Press the left arrow (←) button once. The display will read "BASIC".

25. Press the up arrow (↑) button once. The display will read "CutOut amps".
26. Change the value to the recorded value by pressing the SET button. A cursor will start blinking under the far right digit.
27. Press the left arrow (←) button to move the cursor. Press the up arrow (↑) button to increase the digit. When a digit reaches 9, pressing the up arrow (↑) button again will change the value to 0.
28. Press the SET button to save the value. The LCD will read "CutOut Set -- OK".
29. Press the SEL button. The LCD will read "CutOut amps" along with the programmed value from the previous step.
30. Press the SEL button three times. The LCD will read "EXITMENU".
31. Press the up arrow (↑) button to exit the menu.
32. Adjustment to the control is completed. If the adjustment was done for the left side, restart the procedure for the right side.

## E. SERVING PRODUCT

33. Place the Freezing Cylinder OFF/ON switch in the ON position.
34. Press the PUSH TO FREEZE button.
35. When the product is at 75% consistency, the display will read "SERVE".
36. For normal dispensing, move the spigot handle fully open.
37. The machine dispenses product at a reasonable draw rate. If the machine is overdrawn, the result is a soft product or a product that will not dispense at all. If this occurs, allow the machine to run for approximately 30 seconds before dispensing more product. Spigot rate adjusters are located under the header panel, to the immediate right of each spigot handle. Turning the spigot rate adjuster counterclockwise will decrease the dispense rate.
38. Do not operate the machine when the MIX LOW message is displayed. Refill the mix container immediately.

### NOTE

*The machine has a standby and sleep mode. After a preset number of freezing cycles, it will enter the standby mode (followed by sleep mode) and remain there until someone draws product or presses the PUSH TO FREEZE button. In the sleep mode, the machine will keep the product below 41°F (7.2°C). Sleep modes do not take the place of cleaning and sanitizing. Federal, State, and local regulatory agencies determine frequency of cleaning and sanitizing.*

### 3.11 NORMAL FREEZE DOWN AND OPERATION

The following section contains the recommended operating procedures for the safe operation of the machine.

1. Sanitize immediately before use.
2. Make sure the Freezing Cylinder OFF/ON switch is in the OFF position.
3. Fill the storage containers in the cab with at least 2.5 gallons of mix.
4. Attach the mix inlet probes to the container and place the containers in the refrigerated cab.
5. Place the mix pump switch in the ON position.
6. Place a container under the spigot and open the spigot to allow the mix to flush out about 8 ounces (0.23 liters) of sanitizing solution and liquid mix. Close the spigot.
7. Open the air bleed valve on the front door by pressing and holding. Hold the valve open until the mix level in the freezing cylinder is 1/2" from the air bleed valve.
8. Place the Freezing Cylinder OFF/ON switch in the ON position.

#### NOTE

*After the drive motor starts, there is a 3-second delay before the compressor starts.*

9. Press the PUSH TO FREEZE button.
10. When the product is at 75% consistency, the display will read "SERVE".
11. For normal dispensing, move the spigot handle fully open.
12. The machine dispenses product at a reasonable draw rate. If the machine is overdrawn, the result is a soft product or a product that will not dispense at all. If this occurs, allow the machine to run for approximately 30 seconds before dispensing more product. Spigot rate adjusters are located under the header panel, to the immediate right of each spigot handle (Fig. 3-14). Turning the spigot rate adjuster counterclockwise will decrease the dispense rate.

### CAUTION

#### Risk of Product Damage

Mix pump hose must be repositioned every 800 gallons of mix served or 2 weeks. Failure to comply will result in reduced mix pump liquid capacity, dispense stoppage, popping, and possible mix pump hose leakage. Hose leakage may damage the pump roller assembly and void the factory warranty

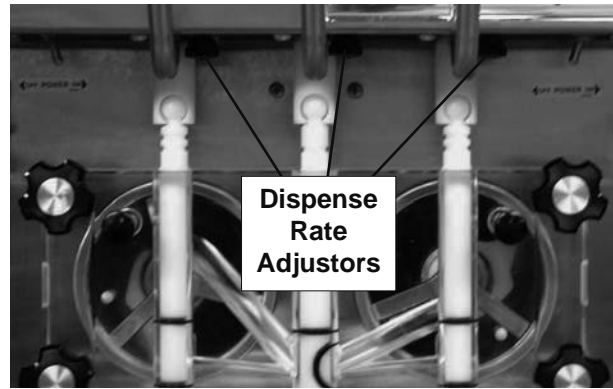

Figure 3-14 Dispensing Product

13. Do not operate the machine when the MIX LOW message is displayed or with less than 1-3/4" (4.4 cm) of mix in the hopper. Refill the hopper immediately.

#### NOTE

*The machine has a standby and sleep mode. After a preset number of freezing cycles, it will enter the standby mode (followed by sleep mode) and remain there until someone draws product or presses the PUSH TO FREEZE button. In the sleep mode, the machine will keep the product below 41°F (5°C). Sleep modes do not take the place of cleaning and sanitizing. Federal, State, and local regulatory agencies determine frequency of cleaning and sanitizing.*

### 3.12 MIX INFORMATION

Mix can vary considerably from one manufacturer to another. Differences in the amount of butterfat content and quantity and quality of other ingredients have a direct bearing on the finished frozen product. A change in machine performance that cannot be explained by a technical problem may be related to the mix.

Proper product serving temperature varies from one manufacturer's mix to another. Mixes should provide a satisfactory product in the 17° to 20°F (-7° to -6°C) range. Diet and low-carb mixes typically freeze to proper consistency at higher temperatures.

When checking the temperature, stir the thermometer in the frozen product to read the true temperature.

Old mix, or mix that has been stored at too high a temperature, can result in a finished product that is unsatisfactory. To retard bacteria growth in dairy based mixes, the best storage temperature range is between 36° to 40°F (2.2° to 4.4° C).



### 3.13 OPERATION OF MIX PUMP

The mix pump switches are located in the upper left hand corner, inside the refrigerated cabinet. When a pump switch is placed in the ON position, the mix pump motor will start pumping mix into the machine cylinder. When the set pressure is reached, the mix pump will shut off automatically. When the switch is placed in the OFF position, the mix pump will be inoperative.

#### NOTE

*The mix pump motor is equipped with an internal overload that will “trip”, disabling the pump when the motor is overloaded. Consult the trouble shooting section for corrective information. The internal overload will automatically reset after cooling. If the condition continues, contact a qualified service person.*

- A. Mix Operation: The peristaltic mix pump contains one continuous mix pump hose. When looking at the face of the peristaltic mix pump, the left side of the hose is the suction or pickup. The right side of the hose is the discharge. Mix is drawn up the suction side of the hose and transferred through the discharge side to the machine (see Figure 3-15).

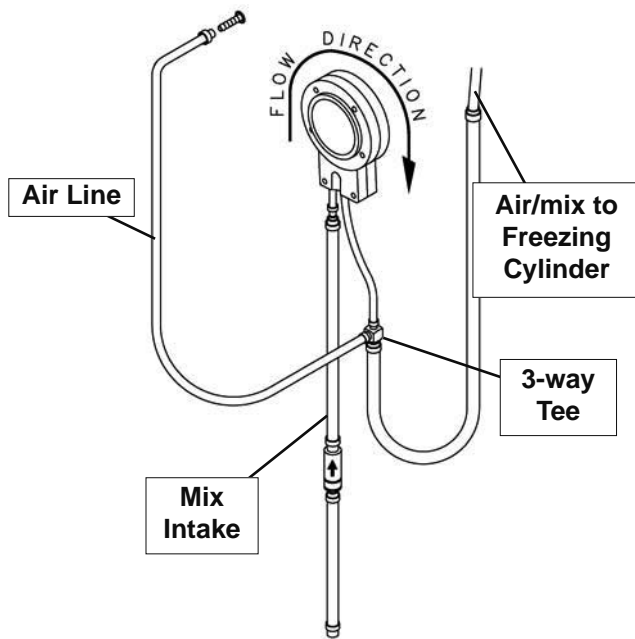

**Figure 3-15 Mix Pump Hose Routing**

- B. Air Operation: The air compressor operates whenever the peristaltic mix pump is running. Air enters through a check valve on the piston downstroke. The air is discharged through a second check valve, on the piston upstroke. The air and mix join at the tee and then travel to the machine.
- C. The overrun adjustment is preset at the factory. If an adjustment becomes necessary, refer to Section 4.

### NOTICE

*Any cleaning procedure must always be followed by sanitizing before filling machine with mix. (Refer to section 3.3)*

### 3.14 MIX PUMP CLEANING

The mix pump is approved for CIP (clean in place) and is thoroughly cleaned as cleaning solutions are pumped through the machine. We recommend completely disassembling the pump and disconnecting tubing every 14 days for inspection of parts to confirm the CIP has been properly performed. If any residue is detected clean or replace those parts as outlined below.

- A. Place the Main Power OFF/ON and Freezing Cylinder OFF/ON switches ON position and press the CLEAN button. Allow the auger to agitate for 5 to 10 minutes.
- B. Remove suction tube from mix container. Draw off the mix remaining in machine barrel.
- C. Pump 2 gallons (7.5 liters) of potable water through machine until water at spigot is free of mix.
- D. Pump 2 gallons (7.5 liters) of 90° to 110°F (32°C to 43°C) detergent solution water through machine. The use of soft water is recommended, along with dishwashing detergents such as “Joy,” “Dawn,” or equivalent.
- E. Place mix pump switch in OFF position. Open spigot to relieve remaining pressure.
- F. Press the CLEAN button to stop the auger and place the Main Power OFF/ON and Freezing Cylinder OFF/ON switches in the OFF position.

### 3.15 DISASSEMBLY AND INSPECTION OF REMOVABLE PARTS

Inspection of removable parts should be made whenever maintenance is performed or pump requires disassembly.

#### **! WARNING**

##### **Hazardous Moving Parts**

Revolving pump head can grab, mangle, and cause serious crushing injury. The Main Power OFF/ON switch must be placed in the OFF position for cleaning and power must be disconnected when disassembling or servicing.

#### NOTE

*If the mix lines or air line is difficult to remove, soften tubing with a rag soaked in hot water. Hose connections may be sprayed with Haynes Sanitary Lubricant for ease of removal. Do not loosen or remove the mix pump cover wing nuts. Maintain the mix pump hose in its operational condition.*

**CAUTION**

**System Under Pressure**

Never disconnect hoses from machine or pump without first opening spigot to relieve pressure.

- A. Loosen clamp and remove air hose from pump compressor.
- B. Loosen clamp and disconnect mix pump hose. Remove the pickup hose, mix check valve and pickup hose adapter (and bag adapter if applicable) as an assembly from mix container.
- C. Completely disassemble both hose assemblies and check valve. Place hoses, tee, check valve assembly, and pickup hose adapter in 90° to 110°F (32°C to 43°C), mild detergent water and wash thoroughly. Use soft bristle brushes to clean inside of fittings. Rinse all parts in clean 90° to 110°F (32°C to 43°C) water (see Figure 3-16 and 3-17).



**Figure 3-16 Removable Parts**



**Figure 3-17 Removable Parts for optional BCS**

- D. Carefully inspect each part for wear or damage. Replace worn or damaged parts.
- E. Wash feed tube and air tube with 90° to 110°F detergent water and brushes provided. Rinse with clean, 90° to 110°F water (See Figure 3-18 and 3-19).



**Figure 3-18 Cleaning Air Tube**



**Figure 3-19 Cleaning Feed Tube**

- F. Prepare two gallons (7.5 liters) of sanitizing solution using a USDA certified grade sanitizing solution. Sanitize all removed parts, then air dry.
- G. Check Hose Service Record decal to determine if hose reposition or replacement is required at this time.
- H. Reassemble both hose assemblies per the diagram located on the inside of the cab door. Reconnect assemblies to the pump and discharge hose, using the clamps. (Refer to Section 2.5 Mix Pump).
- I. Sanitize assembled machine as per instructions outlined in Section 3.9.

## SECTION 4 MAINTENANCE AND ADJUSTMENTS

### 4.1 MACHINE ADJUSTMENT

This section is intended to provide maintenance personnel with a general understanding of the machine adjustments. It is recommended that any adjustments in this section be made by a qualified person.

### 4.2 PRODUCT CONSISTENCY ADJUSTMENT

The operator can adjust product consistency by modifying the Fine Adjustment setting on the membrane switch. This is the only adjustment that can be made by the operator without using a pass code key sequence. Product consistency fine adjustment allows a 0.4 amp maximum adjustment to the drive motor amp draw cutout. Increasing this setting will increase the drive motor amperage cutout and increase product consistency. Follow the instructions below to make fine adjustments to product consistency.

- A. Place the Main Freezer Power switch in the ON position.
- B. Press the SET button on the Control Panel once. Fine Adj will appear on the LCD screen.
- C. Press the up arrow button (↑) until the desired consistency setting is displayed. The higher the number, the firmer the product consistency. The control may be set from 1 to 9. The value increases by 1 each time the up arrow button is pressed. After the value reaches 9, numbering restarts at 0. The 0 setting cannot be set.
- D. Press the SET button once to save the setting and return to the current mode display.

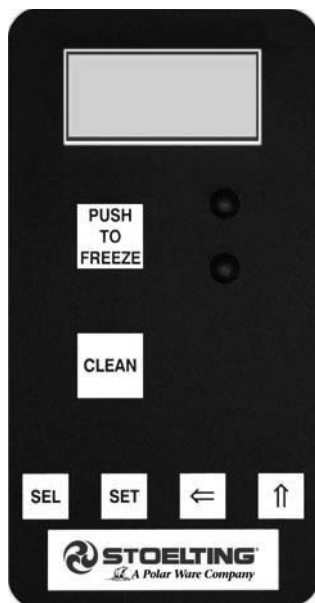

Figure 4-1 Caption

### 4.3 LOCKING THE CONTROL PANEL

The IntelliTec control has a tamper proof mode to prevent unauthorized use. When set, all buttons on the control panel are disabled. Follow the instructions below to lock the control panel

- A. Press and hold the PUSH TO FREEZE button for at least 5 seconds.
- B. While still holding the PUSH TO FREEZE button, press the CLEAN button once.
- C. Release both buttons. An asterisk (\*) will appear on the bottom line of the display, indicating that the control is in the lock out mode.

#### NOTE:

*Repeat steps A, B, and C to unlock the control panel.*

### 4.4 OBTAINING READINGS AND MODIFYING SETTINGS (SERVICE PERSONNEL ONLY)

Readings and settings on the IntelliTec control are accessed through the IntelliTec control menu settings. Locating machine readings and system function settings are done using the up arrow (↑) and left arrow (←) buttons on the membrane switch. A printed IntelliTec Menu Settings sheet is located in the information pouch behind the header panel.

#### IntelliTec Control Readings

To obtain machine readings, locate the value on the machine's menu settings sheet and follow the steps below.

- A. Press and hold the SEL button for 8 seconds. While still holding the SEL button, press the up arrow button (↑). The LCD screen will read DISPLAY.
- B. Release both buttons.
- C. Press the up arrow button (↑) to navigate to the correct reading under DISPLAY or press the left arrow (←) button to navigate to the ERRCODES menu.
- D. Press the up arrow (↑) and left arrow (←) buttons to navigate through the rest of the readings as needed.
- E. When all readings have been obtained, press the up arrow button (↑) from ExitMenu to return to the current mode display.

#### Modifying Control Settings

To change the value of a system function, locate the function on the IntelliTec Settings Menu and follow the steps below.

## IMPORTANT:

*Before making changes to any settings, record the original values. If the setting changes do not achieve desired results, return settings to their original values.*

- A. Press and hold the SEL button for 8 seconds. While still holding the SEL button, press the up arrow button (↑). The LCD Screen will read DISPLAY.
- B. Release both buttons.
- C. Press the left arrow button (←) to get to the correct menu (Basic, Advanced, or Storage).
- D. Press the up arrow button (↑) to navigate to the value that needs to be changed.
- E. Press the SET button to enter the edit mode.
- F. Press the up arrow button (↑) to change the setting.
- G. Press the SET button to save the setting and exit the edit mode.
- H. Press the up arrow (↑) and the left arrow (←) buttons to navigate through the rest of the settings as needed.
- I. When all changes have been completed, press the up arrow button (↑) from ExitMenu to return to the current mode display.

## 4.5 READINGS (SERVICE PERSONNEL ONLY)

The IntelliTec control continuously monitors and records temperatures, voltages, amps, and error code details. Each reading is beneficial to service personnel when troubleshooting.

### DISPLAY READINGS

Following are the readings available under the DISPLAY menu:

#### Cabinet

The temperature of the cab is constantly monitored by the IntelliTec control.

#### Cycles (count)

This reading counts down the number of cycles in the current "Serve Mode". The starting value is dependant upon the Cycles setting on the IntelliTec control.

#### °F and amps

Suction line temperature on the freezing cylinder and drive motor amps are available on the same screen to assist with setup and troubleshooting.

#### Aux. Temp (°F)

This reading provides the ambient temperature around the IntelliTec control board.

#### Supply V (VAC)

A calculated input voltage is recorded.

## ERROR CODE READINGS

The following details are recorded under the ERRCODES menu for each of the last 25 error codes received:

### Err1 (hours)

A numerical count of the last 25 error codes is recorded. When the 26th error has occurred, the earliest error code is erased. A timer also begins when an error occurs. The timer records the number of hours since the error occurred. If power to the machine is interrupted, the timer will stop until power has been restored.

### °F and amps

The suction gas temperature on the freezing cylinder and the drive motor amps are recorded at the time of the error.

### Aux. Temp (°F)

Ambient temperature of the IntelliTec control board is recorded at the time of the error.

### Str (°F)

The storage temperature is recorded at the time of the error.

### VAC and Mode

A calculated input voltage and mode at which the error occurred are recorded. Following are descriptions of each mode:

Mode	Description
0	Start of freezing cycle
1	Compressor and drive motor on
2	Stir Cycle
3	Compressor off
4	"Standby Mode"
5	"Sleep 1 Mode"
6	"Sleep 2 Mode"
7	"Clean Mode"
8	Startup
9	Storage only refrigeration
10	Freezing cycle is shut down
11	Door safety switch triggered
12	High pressure cutout

### Up Time (hours)

This value is a record of the total time the machine has been in service. If power is interrupted, the timer will stop until power is restored. This timer does not reset.

## RUN STATISTICS

In addition to dynamic readings and recorded error code details, the IntelliTec control records rolling averages of run statistics. Following are the readings available under the RUNSTATS menu:

### On Times (sec)

The control records the time of each freezing cycle and provides a rolling average.

### Off Times (sec)

The control records the time between freezing cycles and provides a rolling average.

### Brl. Min (°F)

The lowest average barrel temperature is recorded.

### Brl. Max (°F)

The highest average barrel temperature is recorded.

### Stor Min (°F)

The lowest average cabinet temperature is recorded.

### Stor Max (°F)

The highest average cabinet temperature is recorded.

### Power On (hrs)

This value is a record of the time the machine has been in service. If power is interrupted, the timer will reset.

## 4.6 ADJUSTMENTS (SERVICE PERSONNEL ONLY)

The following adjustments directly affect product consistency and length of time in “Serve Mode”. The default settings have been created using a 5% milkfat soft serve mix and provide optimal product consistency while prolonging product life.

### CutOut (amps)

It is recommended to set the CutOut value at initial startup and when changing mix types. Adjustments to this setting directly affect the length of the freezing cycle and indirectly change product consistency. To properly set the CutOut value, during startup navigate to the “°F” and “amps” values under the Display menu (Refer to Section 4.4), start the machine and freeze the product to the desired consistency. Monitor consistency by taking a 6 ounce sample at each change of the “amps” display. When the desired consistency has been reached, record the temperature and amps, and change the CutOut value to the recorded amps value.

### Cut In T (°F)

After the consistency value has been determined, the Cut In T value can be adjusted. The Cut In T is the temperature of the refrigerant gas coming out of the freezing cylinder. Changing this setting changes the temperature at which the freezing cycle starts. Decreasing the Cut In T decreases the amount of off time. This creates a greater chance of product breakdown by stirring the product often. Increasing the Cut In T increases the amount of off time, which may cause heat shock within the product.

### Cycles (count)

This setting determines the number of freezing cycles during “Serve Mode”. Increasing the value will increase the total time in “Serve Mode”. Factory default is 20 cycles, which results in “Serve Mode” lasting about 2-1/2 hours without the PUSH TO FREEZE button being pressed or a spigot handle being pulled. If the PUSH TO FREEZE button is pressed or the spigot handle is pulled at any time during “Serve Mode”, the Cycles count will reset.

## 4.7 OTHER SETTINGS (SERVICE PERSONNEL ONLY)

Changing any setting on the IntelliTec control will alter machine operation and affect the product temperature, consistency, or life. Refer to the IntelliTec Control System Settings sheet located in the information pouch behind the header panel of the machine. If any of the following settings on the IntelliTec control differ from the System Settings sheet, it is recommended to return those settings to factory defaults.

### Stir On (sec)

Adjustments to this setting affect the amount of time the auger rotates in the stir cycle. The stir cycle occurs in “Serve Mode”, “Standby Mode”, and “Sleep 2 Mode”.

### Stir Off (sec)

Adjustments to this setting affect the time between stir cycles. The stir cycle occurs in “Serve Mode”, “Standby Mode”, and “Sleep 2 Mode”.

### On Time (sec)

Increasing this value will increase the length of the freezing cycle during “Standby Mode” and result in a decrease of average product temperature in the barrel.

### Off Time (sec)

Increasing this value will increase the time between freezing cycles in “Standby Mode” and result in an increase of product temperature in the barrel.

### Stb Time (sec)

This setting determines the total amount of time in “Standby Mode”.

### SI1DrvOn (sec)

Adjustments to this setting affect the amount of time the auger rotates in the stir cycle. This stir cycle only occurs in “Sleep 1 Mode”.

### SI1DrOff (sec)

Adjustments to this setting affect the time between stir cycles. The stir cycle only occurs in “Sleep 1 Mode”.

### SI2CutIn (°F)

Changing this setting affects the temperature at which the freezing cycle starts in “Sleep 2 Mode”.

### SI2CtOut (°F)

Changing this setting affects the temperature at which the freezing cycle stops in “Sleep 2 Mode”.

### DftOffTm (sec)

In “Serve Mode”, this value determines the maximum time without a freezing cycle. If this value is met, a freezing cycle will start. In the event of a freezing cylinder temperature sensor failure, this value affects the amount of time between freezing cycles during “Serve Mode”.

### Refriger

This setting changes how the control handles the storage refrigeration cycle. The setting for the left control is “Cabinet” and “None” on the right control.

### CabCutIn (°F)

If the Refriger value is set to Cabinet, this setting determines the temperature at which the refrigeration cycle starts. If None, 1 Hopper, or 2 Hopper is selected for the Refriger setting, CabCutIn will not be shown on the IntelliTec menu.

### CabCtOut (°F)

If the Refriger value is set to Cabinet, this setting determines the temperature at which the refrigeration cycle stops. If None, 1 Hopper, or 2 Hopper is selected for the Refriger setting, CabCtOut will not be shown on the IntelliTec menu.

### Cab Off

If the Refriger value is set to Cabinet and the temperature sensor in the cabinet fails, this setting determines the time between refrigeration cycles. If None, 1 Hopper, or 2 Hopper is selected for the Refriger setting, Cab Off will not be shown on the IntelliTec menu.

### Cab On

If the Refriger value is set to Cabinet and the temperature sensor in the cabinet fails, this setting determines the length of the refrigeration cycle. If None, 1 Hopper, or 2 Hopper is selected for the Refriger setting, Cab On will not be shown on the IntelliTec menu.

## 4.8 OVERRUN ADJUSTMENT

The product, when served, is a combination of air and mix. Overrun is a measure of the amount of air blended into the mix.

Overrun can be expressed in terms of the amount of weight loss for a given volume. For example, if a pint of liquid mix weighs 18 ounces and a pint of frozen product with air added weighs 12 ounces, the overrun is said to be 50 percent:  $18 \text{ oz.} - 12 \text{ oz.} = 6 \text{ oz.}$ ,  $(6/12) \times 100 = 50\%$

The overrun can be checked by placing a one pint container on an ice cream scale and zeroing out the scale. Then fill a one pint container with frozen product. The container should be filled over the top and leveled with a straightedge. The product should not contain any air pockets. When weighed on an ice cream scale, one pint of product should weigh 12 to 13 ounces.

The mix pump has been preset at the factory to produce a product with approximately 40% overrun. Because of differences in mix formulation, temperatures and barometric pressure, this figure may vary. It will be necessary for approximately 2 gallons of mix to be pumped through the machine before overrun changes in the product are noticeable.

Overrun is controlled by the length of the air compressor piston stroke within the piston cylinder. Lengthening the stroke within the cylinder will increase overrun. Conversely, shortening the stroke will decrease overrun. To perform an overrun adjustment, refer to the following procedure:

- A. Turn the mix pump switch to the OFF position. Disconnect power sources/circuit breakers.
- B. Remove the back panel from the machine.
- C. On the air compressor side of the pump, locate the long/slender piston rocking arm. The rocking arm downward travel is limited by a stationery cam. On the face of the cam there is an overrun setting indicator plate numbered 3 through 8 and an adjustment knob (Fig. 4-2).



### WARNING

#### Hazardous Voltage

The Main Freezer Power switch must be placed in the OFF position when disassembling for servicing. The machine must be disconnected from electrical supply before removing any access panel. Failure to disconnect power before servicing could result in death or serious injury.

- D. The overrun setting is indicated by a pin.
- E. To adjust overrun, loosen the allen-head screw (located within the center of the adjustment knob) with the 5/32" allen wrench provided. Rotate the adjustment knob counterclockwise to a higher number for higher overrun, or clockwise to a lower number for lower overrun. Each number multiplied by 10 represents the overrun percentage (i.e. setting 4 = 40% overrun).



**Figure 4-2 Overrun Adjustment**

- F. Tighten the allen screw, then place the wrench back in its clip. Replace the lower back panel and secure with the four screws. Turn the mix pump power switch to the ON position.

#### 4.9 MIX PUMP HOSE REPOSITION

Mix pump hose must be repositioned every 800 gallons of mix pumped or every 2 weeks. Failure to reposition the hose will result in reduced mix pump liquid capacity, dispense stoppage, popping, and possible mix pump hose leakage. Follow the steps below to reposition the hose:

- A. Run cleaning solution through pump.
- B. Turn the pump off and relieve any pressure by opening the spigot.
- C. Grasp the pickup hose end of the mix pump hose with one hand and turn the pump on. Pull down on the pickup hose end until 12 to 14 inches of tubing has fed through the pump then turn the pump off (Fig. 4-3).
- D. Loosen the small clamp at the pick-up hose adapter and disconnect the mix pump hose.
- E. Cut 7-1/2 inches off the end of the mix pump hose.
- F. Reconnect the mix pump hose to the adapter.
- G. Continue normal operation. Mix hose will automatically reposition itself with the adapter near the black cover.

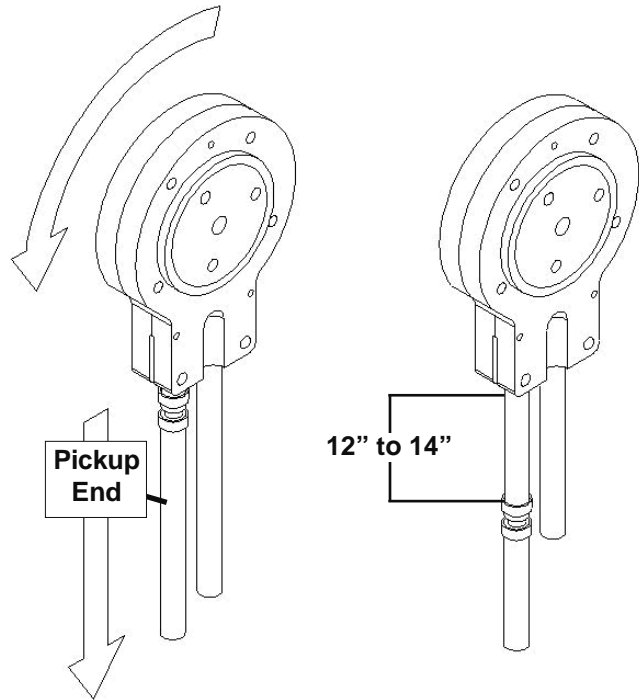

**Figure 4-3 Pump Hose Reposition**

#### NOTE

*Each hose is long enough for 3 repositions before replacement is required.*

#### 4.10 MIX PUMP HOSE REPLACEMENT

Mix pump hose must be replaced when tubing cannot be further repositioned (every four to eight weeks). Failure to comply will result in hose failure and possible pump damage. Follow the steps below to replace the hose:

- A. Run cleaning solution through pump.
- B. Turn the pump off and relieve any pressure by opening the spigot.
- C. Disconnect the mix pump hose at each end.
- D. Grasp the discharge hose end with one hand and turn the pump on. Pull down on the hose until all of the remaining hose is removed from the pump. Turn pump off.
- E. Rotate pump roller assembly so one roller is at the 6:00 position.
- F. Use a brush that fits in the opening and clean the pump roller assembly, first with detergent water and then clear water.
- G. Connect the new mix pump hose to the pickup hose adapter using the small clamp.
- H. Feed one end of the mix pump hose into the pickup hose side (left) of the black cover.

## NOTE

Feed the tube into the clamp so the natural curve of the tube is towards the outside of the black cover. This prevents the hose from looping around the black cover twice.

- I. Gently push the hose into the black cover until it begins to feed.
- J. Allow the hose to feed itself through the pump until about 6" (15cm) remains on the entering side.
- K. Turn pump off.
- L. Connect the mix pump hose to the elbow fitting (located on the left side of the mix line manifold) using a small hose clamp. Be careful not to twist the mix hose.
- M. Turn the pump on.
- N. Allow the remaining 6" (15cm) of tubing to feed through the pump until the hose adapter prevents further feeding.
- O. Turn the pump off.

## CAUTION

### Risk of Product Damage

Air/Mix Tee must remain below the black cover clamp. If the Tee is above the pump, the mix may drain into the air compressor, resulting in pump damage.

- P. Connect the free end of the mix pump hose to the 3-way Tee. When all connections are complete, the 3-way Tee must be lower than the black pump housing.
- Q. The pump is now ready to sanitize.

## 4.11 CAB TEMPERATURE ADJUSTMENT

Cab temperature is monitored and controlled by two settings on the IntelliTec control: CabCutIn and CabCtOut. The cut in value determines the temperature at which the refrigeration cycle starts. The cut out setting determines when the cycle stops. To change the CabCutIn or CabCtOut, follow the steps below:

- A. Press and hold SEL button for 8 seconds. While still holding the SEL button, press the up arrow button (↑). The LCD Screen will read "Display".
- B. Release both buttons.
- C. Press the left arrow button (←) three (3) times to navigate to the Storage menu.
- D. Press the up arrow button (↑) once to navigate to the CabCutIn value. Record this value.

## IMPORTANT:

Before making changes to any settings, record the original values. If the setting changes do not achieve desired results, return settings to their original values.

- E. Press SET button to enter edit mode.
- F. Press the up arrow button (↑) to increase the number to the value required. The value increases by 1 each time the up arrow button (↑) is pressed. After the value reaches 9, numbering restarts at 0.
- G. Press SET button to save the setting and exit the edit mode.
- H. Press the up arrow button (↑) once to navigate to the CabCtOut value. Record this value.
- I. Press SET button to enter edit mode.
- J. Press the up arrow button (↑) to increase the number to the value required. The value increases by 1 each time the up arrow button (↑) is pressed. After the value reaches 9, numbering restarts at 0.
- K. Press SET button to save the setting and exit the edit mode.
- L. Press the up arrow (↑) and left arrow (←) buttons to navigate to ExitMenu.
- M. Press the up arrow button (↑) from ExitMenu to return to the Mode Screen.
- N. Locate the Specification Sheet for F431 Control behind the header panel and record the new values on this sheet.



## WARNING

### Hazardous Voltage

The Main Freezer Power switch must be placed in the OFF position when disassembling for servicing. The machine must be disconnected from electrical supply before removing any access panel. Failure to disconnect power before servicing could result in death or serious injury.

## 4.12 DRIVE BELT TENSION ADJUSTMENT

- A. Remove a side panel and the back panel.
- B. Use a Burroughs Belt Tension Gauge to set the tension for the drive belt. Set the belt tension to 40-50 lbs.
- C. If an adjustment is necessary, loosen the four motor plate retaining nuts, adjust belt tension then retighten the four nuts.

## NOTE

Belt life will be increased if new drive belts are tightened after two or three weeks of operation.



#### 4.13 CONDENSER CLEANING (AIR-COOLED MACHINES)

The condenser requires periodic cleaning. To clean the condenser, refer to the following steps:

- A. Lift the condenser filter off of the machine cover panel. Visually inspect the condenser filter for dirt (Fig. 4-4).



Figure 4-4 Removing Condenser Filter

- B. If the condenser filter is dirty, vacuum or brush it clean. Rinse it with clean water and allow it to dry before replacing it on the machine.

#### NOTE

*If the condenser is not kept clean, refrigeration efficiency will be lost.*

#### 4.14 PREVENTATIVE MAINTENANCE

It is recommended that a preventative maintenance schedule be followed to keep the machine clean and operating properly. The following steps are suggested as a preventative maintenance guide.

The United States Department of Agriculture and the Food and Drug Administration require that lubricants used in food zones be certified for this use. Use lubricants only in accordance with the manufacturer's instructions.

- A. Daily checks  
Check for any unusual noise or condition and repair immediately.
- B. Monthly checks
  1. Check drive belts for wear and tighten belts if necessary. (Refer to section 4.12)
  2. Check the condenser filter for dirt. (Refer to section 4.13).

#### 4.15 EXTENDED STORAGE

Refer to the following steps for winterizing the machine or for storing the machine over any long period.

- A. Clean all of the parts that come in contact with mix thoroughly with warm detergent. Rinse in clear water and dry all parts. Do not sanitize.

#### NOTE

*Do not let cleaning solution stand in machine barrel or mix pump during the shutdown period.*

- B. Remove, disassemble, and clean the front door, auger shaft, and mix pump. Leave disassembled during the shutdown period.
- C. Place the plastic auger flights in a plastic bag with a moist paper towel. This will prevent the flights from becoming brittle if exposed to dry air over an extended period (over 30 days).
- D. For water-cooled machines that are left in unheated buildings, or buildings subject to freezing, the water must be shut off and disconnected. Disconnect the fittings at the water inlet and the water outlet lines of the machine. The fittings are located at the rear of the machine. Run the compressor for 2 - 3 minutes to open the water valve. Blow out all the water, first through the water inlet, then through the water outlet lines with air or carbon dioxide. Drain the water supply line coming to the machine.
- E. Place the Pump OFF/ON switch and the Main Freezer Power OFF/ON switch in the OFF position.
- F. Disconnect the machine from the source of the electrical supply in the building.



## SECTION 5 TROUBLESHOOTING

### 5.1 ERROR CODES

When the machine experiences a problem, one of the following error codes will be displayed on the control panel. Each error code directs you to the system location of the malfunction.

#### ERROR CODE MALFUNCTION

1	Soft
2	High Torque
3	Extended Run Time
4	Clean
5	Barrel Sensor
6	Hopper Sensor
7	Drive Motor
8	Cab Sensor
9	High Pressure Cutout
10	Auxiliary Sensor
11	Low Temperature

To return the machine to normal operation, any error causing condition must be corrected and the Freezing Cylinder Off-On switch must be placed in the Off position and back in the On position before the affected side of the machine will return to normal operation.

### 5.2 TROUBLESHOOTING - ERROR CODES

#### Error Code 1 - Soft Error

The Soft Error (E1) is an internal control board error that is logged for future analysis. The refrigeration is never stopped and the machine will continue to operate normally.

#### Error Code 2 - High Torque

If the control panel displays a High Torque Error (E2), the controller has sensed that the drive motor is running at 125% of the preset CutOut amp setting for 10 or more seconds. This may be due to the product consistency adjustment being set too high. Place the Main Power OFF/ON switch in the OFF position, wait until the product in the freezing cylinder thaws to a reasonably soft consistency and return the Main Power switch to the ON position. Follow the steps in section 3 to reduce product consistency by a few levels. If the error persists, contact your authorized Stoelting Distributor for further assistance.

#### Error Code 3 - Run Time

The Run Time Error (E3) occurs when the compressor runs continuously for 20 minutes without the product reaching consistency in "Serve Mode" or if the product does not reach proper temperature in "Sleep 2 Mode". This

error is generally caused by very low mix levels in the machine's mix container or from product breakdown. Another common cause results from a restriction preventing mix from entering the freezing cylinder. Check the mix in the cabinet. If the level mix is low, add mix. If there is a possibility that the mix is broken down, clean and sanitize the machine and replace the mix with fresh product.

Ice crystals in the liquid mix container can clog the mix inlet system and prevent mix from entering the freezing cylinder. Thoroughly thaw mix per manufacturer's recommendations. To check for ice crystals, pour a small amount of product in the mix container through a clean and sanitized sieve or strainer. If ice crystals are in the mix, check the temperature of the walk-in cooler where the mix is stored or the temperature of the machine's cabinet.

Check the condition of the neoprene hose running through the mix pump head. If it shows signs of wear, rotate or replace it as outlined in Section 3.

In air cooled machines, the Run Time Error may indicate that airflow within the machine has reduced or stopped. Check the sides and top of the machine for anything that would restrict airflow.

If the error persists after attempting to clear it, contact your Authorized Stoelting Distributor for further assistance.

#### Error Code 4 - Clean

If the machine is left in the Clean Mode for more than 20 minutes, the control panel will display a Clean Error (Error 04). This condition does not reflect a problem with the machine itself. The Clean Error has been programmed into the controller as a safeguard to protect the machine from potential damage caused by the machine being accidentally left in "Clean Mode". The control will attempt to restart itself after 5 minutes. The display will then flash and read Restart. To immediately clear the Clean Error, place the Main Power Off-On switch in the Off position and back in the On position. After restarting the machine, a refrigeration cycle will begin. This protects the product in case the clean button was pressed by mistake.

#### Error Code 5 - Freezing Cylinder Sensor

The Freezing Cylinder Sensor Error (E5) indicates a failure of the barrel sensor or an extreme out of range condition (< -34°F or > 99°F). If the control panel displays an E5, place the Freezing Cylinder Off-On switch in the Off position and back in the On position. If the error persists, contact your Authorized Stoelting Distributor for further assistance.

#### **NOTE**

*When the machine encounters a Freezing Cylinder Sensor Error, the machine will continue to run using preset timers. This mode will allow the operator to continue serving product until the machine can be serviced.*

#### Error Code 6 - Hopper Sensor (single hopper machines)

The Hopper Sensor Error (E6) will not occur on the F431 machine.

#### Error Code 7 - Drive Motor

If the control panel displays a Drive Motor Error (E7), the control does not sense current coming from the drive motor. Place the Freezing Cylinder Off-On switch in the Off position and back in the On position. If the error persists, contact your Authorized Stoelting Distributor for further assistance.

#### Error Code 8 - Cab Sensor

A Cab Sensor Error (E8) indicates a cabinet temperature sensor failure or. This error will also appear in an extreme out of range condition (< -34°F or > 99°F). If the control panel displays an E8, place the Freezing Cylinder Off-On switch in the Off position and back in the On position. If the error persists, contact your Authorized Stoelting Distributor for further assistance.

#### Error Code 9 - High Pressure Cutout

High Pressure Cutout Errors (E9) are usually caused by a dirty or inefficient condenser.

In air cooled condenser models, check for proper air clearance around the machine.

In water cooled condenser models check for proper water flow.

If the error persists, contact your Authorized Stoelting Distributor for further assistance.

#### Error Code 10 - Auxiliary Sensor

An Auxiliary Temperature Sensor Error (R10) occurs if the temperature sensor on the control board fails. Place the Freezing Cylinder Off-On switch in the Off position and back in the On position. If the error persists, contact your Authorized Stoelting Distributor for further assistance.

#### Error Code 11 - Low Temperature

The Low Temperature Error (E11) occurs when the temperature of the gas refrigerant at the freezing cylinder sensor falls below -20°F. Although the machine will not shut down, the active freezing cycle will immediately end. This error usually occurs when the machine continues to run in a low mix condition or if the machine runs out of mix. The product towards the front of the freezing cylinder tends to freeze solid. When the temperature on the freezing cylinder lowers to the preset value, the IntelliTec control will display an E11.

#### ALTERNATING FLASHING CONTROL PANEL LIGHTS

The display panel lights will flash in an alternating sequence under any error codes. Clear the error and place the Freezing Cylinder Off-On switch in the Off position and back in the On position.

### 5.3 TROUBLESHOOTING - MACHINE

PROBLEM	POSSIBLE CAUSE	REMEDY
<b>Drive motor (auger) “kicks-out”, or does not run.</b>	<ol style="list-style-type: none"> <li>1. Power to machine is off.</li> <li>2. Low line voltage.</li> <li>3. Product too hard.</li> <li>4. Front door not installed securely.</li> </ol>	<ol style="list-style-type: none"> <li>1. Check power to machine.</li> <li>2. Check, must be <math>\pm 10\%</math> of nameplate voltage.</li> <li>3. Raise overrun. (See Section 4.8)</li> <li>4. Install front door securely.</li> </ol>
<b>Compressor does not operate.</b>	<ol style="list-style-type: none"> <li>1. Power to machine if off.</li> <li>2. Low line voltage.</li> <li>3. Compressor internal overload is cut-out.</li> <li>4. Front door not installed securely.</li> </ol>	<ol style="list-style-type: none"> <li>1. Check power to machine.</li> <li>2. Check, must be <math>\pm 10\%</math> of nameplate voltage.</li> <li>3. Check condenser (air cooled)(See Sect. 4.13), or water supply (water cooled).</li> <li>4. Install front door securely.</li> </ol>
<b>Product too soft.</b>	<ol style="list-style-type: none"> <li>1. CutOut setting is too low</li> <li>2. Product break down.</li> </ol>	<ol style="list-style-type: none"> <li>1. Adjust CutOut setting to match product requirements.(See Section 3.10)</li> <li>2. Fill with fresh product.</li> </ol>
<b>Freeze-up. (Product will not dispense easily.)</b>	<ol style="list-style-type: none"> <li>1. CutOut setting is too high.</li> <li>2. Low overrun setting.</li> <li>3. Low pump pressure.</li> <li>4. Large air pocket in barrel.</li> <li>5. Auger turning counter-clockwise.</li> </ol>	<ol style="list-style-type: none"> <li>1. Adjust CutOut setting to match product requirements.(See Section 3.10)</li> <li>2. Raise overrun. (See Section 4.8)</li> <li>3. Check pump pressure.</li> <li>4. Purge air from barrel.</li> <li>5. Change rotation to clockwise.</li> </ol>
<b>Rear auger seal leaks.</b>	<ol style="list-style-type: none"> <li>1. Seal missing or installed wrong.</li> <li>2. Rear seal o-ring missing, broken or not lubricated.</li> <li>3. Worn or scratched shaft.</li> </ol>	<ol style="list-style-type: none"> <li>1. Install correctly. (See Section 3.8)</li> <li>2. Inspect for breakage and lubricate properly (See Section 3.8)</li> <li>3. Replace shaft.</li> </ol>
<b>Spigot leaks.</b>	<ol style="list-style-type: none"> <li>1. Spigot parts are not lubricated.</li> <li>2. Chipped or worn o-rings.</li> <li>3. O-rings on spigot installed wrong.</li> <li>4. Nicks or scratched on front door where spigot is located.</li> </ol>	<ol style="list-style-type: none"> <li>1. Lubricate. (See Section 3.13)</li> <li>2. Replace o-rings.</li> <li>3. Remove spigot and check o-rings.</li> <li>4. Replace front door.</li> </ol>
<b>Drive belts slipping or squealing.</b>	<ol style="list-style-type: none"> <li>1. Drive belt tension not correct.</li> <li>2. Worn belt(s).</li> <li>3. Low overrun.</li> </ol>	<ol style="list-style-type: none"> <li>1. Adjust belt tension. (See Section 4.12)</li> <li>2. Replace belts.</li> <li>3. Check for air leak.</li> </ol>
<b>Mix temperature too warm in cab.</b>	<ol style="list-style-type: none"> <li>1. Temperature control set too warm.</li> <li>2. Cab door is open.</li> </ol>	<ol style="list-style-type: none"> <li>1. Decrease CabCtOut and CabCutIn (See Section 4.7)</li> <li>2. Close the cab door.</li> </ol>

## 5.4 TROUBLESHOOTING - MIX PUMP

PROBLEM	POSSIBLE CAUSE	REMEDY
<p><b>Pump motor does not run.</b></p>	<ol style="list-style-type: none"> <li>1. Power to pump is off.</li> <li>2. Low voltage.</li> <li>3. Mix pump hose jammed inside black cover/clamp.</li> <li>4. Pump motor overloaded.</li> <li>5. Pressure switch on pump is defective.</li> <li>6. Defective motor/capacitor.</li> <li>7. Defective toggle switch.</li> </ol>	<ol style="list-style-type: none"> <li>1. Supply power to pump.</li> <li>2. Check for low voltage.</li> <li>3. Disconnect pump from power source. Remove four cover/clamp thumb screws. Separate cover/clamp halves and remove outer half. Remove jammed hose. Clean and re-install cover/clamp and tighten four thumb screws securely. Allow motor thermal overload to reset.</li> <li>4. Allow internal thermal overload to reset; determine overload cause and repair.</li> <li>5. Check mechanical operation and continuity of pressure switch.</li> <li>6. Check motor amperage draw and/or capacitor. Replace motor or capacitor.</li> <li>7. Check continuity; repair or replace.</li> </ol>
<p><b>Pump operates but cylinder will not fill.</b></p>	<p>NOTE 1: A PROPERLY WORKING PUMP WILL FILL AN 8 OZ. CUP WITH MIX IN ABOUT 9 SECONDS.</p> <p>NOTE 2: IMMEDIATELY AFTER A BAG CHANGE THE PUMP MAY BE UNABLE TO REESTABLISH IT'S PRIME WITH THE SYSTEM AT OPERATING PRESSURE. IN THIS CASE, TURN THE PUMP OFF. DRAW 2-3 PINTS TO REDUCE SYSTEM PRESSURE TO ZERO. TURN PUMP ON. PURGE REMAINING AIR IN MIX BAG AND PICK-UP HOSE.</p> <p><b>IMPORTANT: Before connecting the pick-up hose to the mix bag, remove as much air from the mix bag as possible.</b></p> <ol style="list-style-type: none"> <li>1. Out of Mix.</li> <li>2. Mix pump hose kinked inside black cover/clamp.</li> <li>3. Hoses assembled incorrectly.</li> <li>4. Mix pump hose service life is exceeded.</li> <li>5. Mix pump hose not connected to machine.</li> <li>6. Ice crystals in mix.</li> <li>7. Mix bag drawn against adapter.</li> <li>8. Foreign objects in mix.</li> <li>9. Check valve is backwards.</li> </ol>	<ol style="list-style-type: none"> <li>1. Replenish mix supply.</li> <li>2. Disconnect pump from power source. Remove four cover/clamp thumb screws. Separate cover/clamp halves and remove outer half. Remove jammed hose. Clean and re-install cover/clamp and tighten four thumb screws securely. Allow motor thermal overload to reset.</li> <li>3. Refer to diagram for correct hose connections.</li> <li>4. Reposition/replace mix pump hose. See Section 4.9</li> <li>5. Connect mix pump hose to machine.</li> <li>6. Completely thaw mix prior to use.</li> <li>7. Assure bag is clear of pick-up tube.</li> <li>8. Clear blockage. Use fresh mix.</li> <li>9. Observe flow arrow for proper orientation.</li> </ol>
<p><b>Overrun too low or no overrun.</b></p>	<ol style="list-style-type: none"> <li>1. Overrun setting too low.</li> <li>2. Air leak.</li> <li>3. Air compressor not pumping air.</li> <li>4. Air check valve in backwards.</li> </ol>	<ol style="list-style-type: none"> <li>1. Increase overrun setting.</li> <li>2. Tighten all hose clamps.</li> <li>3. Contact local Stoelting Distributor.</li> <li>4. Check arrow for direction of flow.</li> </ol>

PROBLEM	POSSIBLE CAUSE	REMEDY
<b>Overrun too high.</b>	<ol style="list-style-type: none"> <li>1. Mix pump hose service life is exceeded.</li> <li>2. Out of mix.</li> <li>3. Overrun setting too high.</li> <li>4. Pick-up leg of mix pump hose is collapsing.</li> </ol>	<ol style="list-style-type: none"> <li>1. Reposition/replace mix pump hose.</li> <li>2. Replenish mix supply.</li> <li>3. Decrease overrun setting.</li> <li>4. Reposition hose.</li> </ol>
<b>Replacement mix pump hose won't feed through pump.</b>	<ol style="list-style-type: none"> <li>1. Feeding hose into discharge hole of mix pump cover.</li> <li>2. Hose ends not cut squarely.</li> <li>3. Force feeding too quickly.</li> <li>4. Pump motor not running.</li> </ol>	<ol style="list-style-type: none"> <li>1. Feed hose into suction side of cover.</li> <li>2. Carefully cut hose end off squarely (no tails).</li> <li>3. Gently and slowly assist feeding of hose up into pick-up hose side of cover.</li> <li>4. Turn on motor switch.</li> </ol>
<b>Air exiting mix pick-up hose.</b>	<ol style="list-style-type: none"> <li>1. Pickup tube check valve missing.</li> </ol>	<ol style="list-style-type: none"> <li>1. Contact local Stoelting Distributor.</li> </ol>
<b>Dispensed product air "pops"</b>	<ol style="list-style-type: none"> <li>1. Overrun setting too high.</li> <li>2. Mix pump hose service life is exceeded.</li> <li>3. Overdrawing the machine's capacity.</li> <li>4. Recent low mix condition.</li> </ol>	<ol style="list-style-type: none"> <li>1. Decrease overrun setting.</li> <li>2. Reposition/replace mix pump hose.</li> <li>3. Reduce dispense rate.</li> <li>4. Open spigot fully and allow excess air to escape.</li> </ol>
<b>Mix leakage from pump.</b>	<b>CAUTION: To prevent mix pump damage from dried mix deposits, immediately disassemble and clean pump.</b>	
	<ol style="list-style-type: none"> <li>1. Mix pump hose service life is exceeded.</li> </ol>	<ol style="list-style-type: none"> <li>1. Remove mix pump hose. Disconnect pump from power source. Remove mix pump cover/clamp. Clean the rollers a small amount of soapy water. Clean mix from pump. See Section 4.2 for hose replacement.</li> </ol>
<b>Pump is noisy/ squeaking.</b>	<p>NOTE: THE ACTION OF THE AIR COMPRESSOR ROCKING ARM CREATES A REPETITIVE CLICKING SOUND DURING OPERATION. THIS IS NORMAL.</p> <p>NOTE: THE PERISTALTIC MIX PUMP HAS THREE SQUEEZE ROLLERS WHICH USE SELF LUBRICATING BEARINGS. IF SQUEAKING EXISTS WITH THE MIX PUMP HOSE IN PLACE, AND STOPS WITH THE HOSE REMOVED, THE SQUEEZE ROLLER BEARINGS CAN BE LUBRICATED USING A SILICONE BASED SPRAY. REMOVE THE MIX PUMP HOSE. DISCONNECT PUMP FROM ELECTRICAL POWER. REMOVE FOUR COVER/CLAMP THUMBSCREWS. REMOVE ENTIRE COVER/CLAMP AS ONE UNIT. SPRAY SILICONE BASED LUBRICANT ON EACH END OF EACH SQUEEZE ROLLER. SPIN ROLLERS TO WORK LUBRICANT INTO BEARINGS. REPEAT AS NEEDED.</p> <p><b>CAUTION: DO NOT USE CLEANING/DISSOLVING TYPE LUBRICANTS LIKE WD-40. THESE LUBRICANTS ARE NOT BEARING FRIENDLY AND WILL ACCELERATE BEARING WEAR.</b></p>	
<b>Mix in air hoses.</b>	<ol style="list-style-type: none"> <li>1. Air/mix tee above black cover/clamp.</li> <li>2. Air leak.</li> <li>3. Mix hose on wrong air/mix tee fitting.</li> <li>4. Pressure control manifold o-ring leak.</li> </ol>	<ol style="list-style-type: none"> <li>1. Air/mix tee must be below black cover/clamp.</li> <li>2. Tighten all hose clamps.</li> <li>3. Refer to diagram for correct hose connections.</li> <li>4. Check o-ring and manifold; replace as required.</li> </ol>





## SECTION 6 REPLACEMENT PARTS

### 6.1 DECALS AND MISCELLANEOUS PARTS

Part Number	Description	Quantity
324014	Decal - Black Arrow on White Back	-
324065	Decal - Water Inlet	-
324103	Decal - Caution Rotating Shaft	-
324106	Decal - Caution Electrical Wiring Materials	-
324107	Decal - Caution Hazardous Moving Parts	-
324125	Decal - Danger Electric Shock Hazard	-
324141	Decal - Caution Rotating Blades	-
324200	Decal - High Pressure Cut-Out	-
324208	Decal - Attention Refrigerant Leak Check	-
324346	Decal - Caution Hazardous Moving Parts	-
324477	Decal - Electrical Box - R.H.	1
324478	Decal - Electrical Box - L.H.	1
324509	Decal - Cleaning Instructions	-
324566	Decal - Wired According To	-
324584	Decal - Adequate Ventilation 3"	1
324686	Decal - Danger Automatic Start	4
324799	Decal - Pump Off / On	2
324803	Decal - Domed Stoelting Logo (Large) (Header Panel)	1
324804	Decal - Domed Stoelting Swirl (Header Panel)	1
324825	Decal - Main Freezer Power	1
324826	Decal - Cab Off	1
324827	Decal - Freezing Cylinder	2
208135	Brush - 4" x 8" x 16" (Barrel)	1
208380	Brush - 1/4" x 3" x 14"	1
208387	Brush - 1/2" x 5" x 24"	1
208465	Brush - 1" x 3-1/2" x 18"	1
208467	Brush - 3/8" x 1" x 5"	1
232734	Cap - Rosette	4
417006	Grid - Drip Tray (Metal)	1
508048	Hex Drive Anti Seize (Spline Lubricant) - 2oz. Tube	1
508135	Petro Gel - 4oz. Tube	1
624677-5	O-Ring - Spigot Extension - Black (5 Pack)	3
744273	Tray - Drip	1
2177072	Extension - Spigot - 1.5"	0
2177073	Extension - Spigot - 2.5"	3
2177074	Extension - Spigot - 3.2"	0

## 6.2 FRONT DOOR AND AUGER PARTS

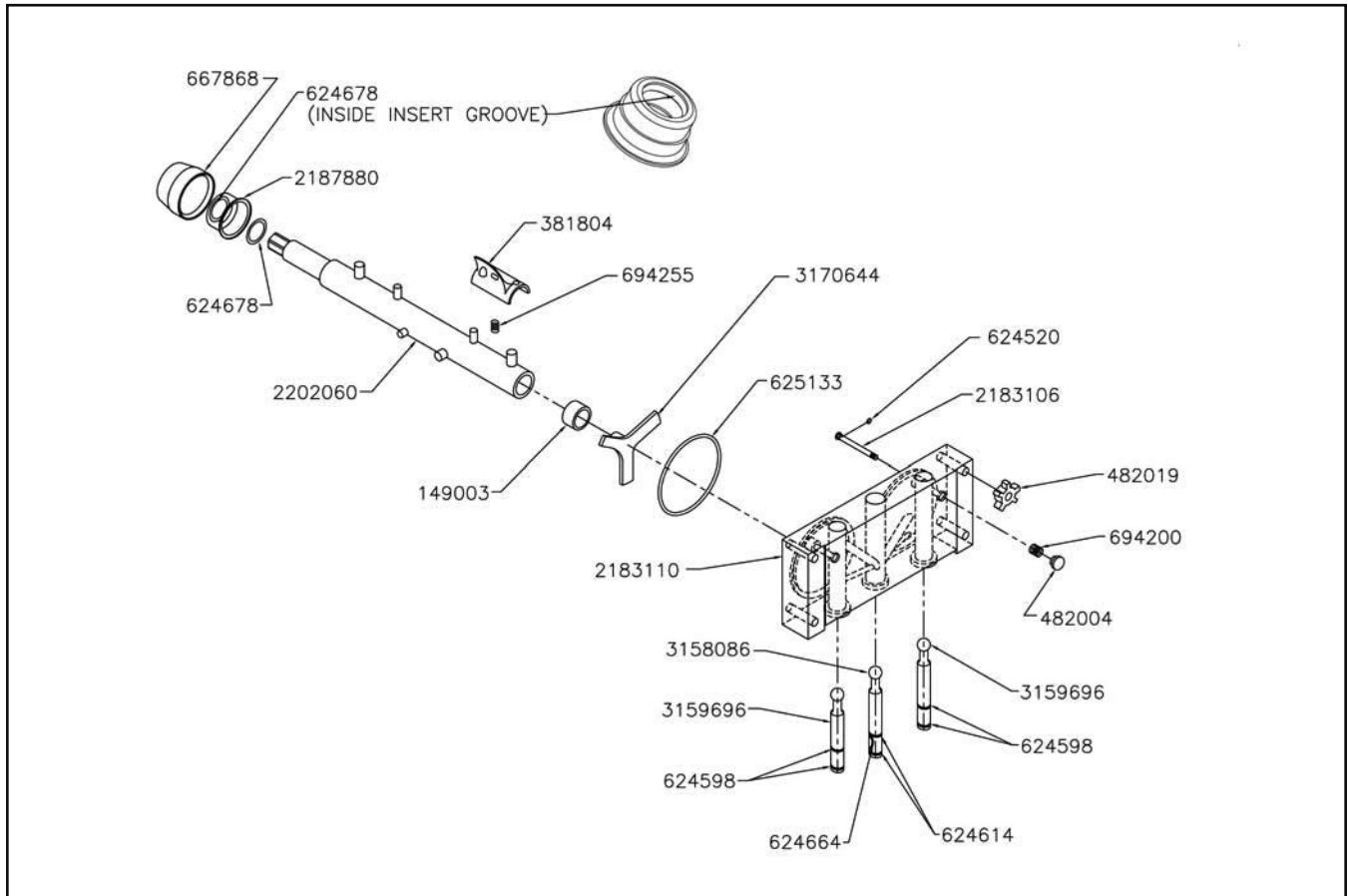

\* If you are replacing a front door without side grooves, the spigot extensions and rosette caps also need to be replaced.

Part Number	Description	Quantity
149003	Bushing - Front Auger Support	2
381804	Auger Flight (Has 4 per Barrel)	8
482004	Knob (Air Bleed Valve & Spigot Body Adjustment)	2
482019	Knob - Front Door (Black)	4
624520-5	O-Ring - Air Bleed Valve - Black (5 Pack)	2
624598-5	O-Ring - Outside Spigot - Black (5 Pack)	4
624614-5	O-Ring - Top & Bottom Center Spigot - Black (5 Pack)	2
624664-5	O-Ring - Middle Center Spigot - Black (5 Pack)	1
624678-5	O-Ring - Rear Seal - Black (5 Pack)	2
625133	O-Ring - Front Door - Red	2
667868	Seal - Rear Auger (Orange)	2
694200	Spring - Air Bleed Valve	2
694255	Spring - Auger Flight	8
1151859	Adapter - Rear Seal	2
2183106	Valve - Air Bleed	2
2183110	Door w/Pins	1
2202060	Auger Shaft	2
3158086	Spigot Body - Center	1
3159696	Spigot Body - Outer	2
3170644	Support - Front Auger	2

### 6.3 CAB TUBING ASSEMBLY

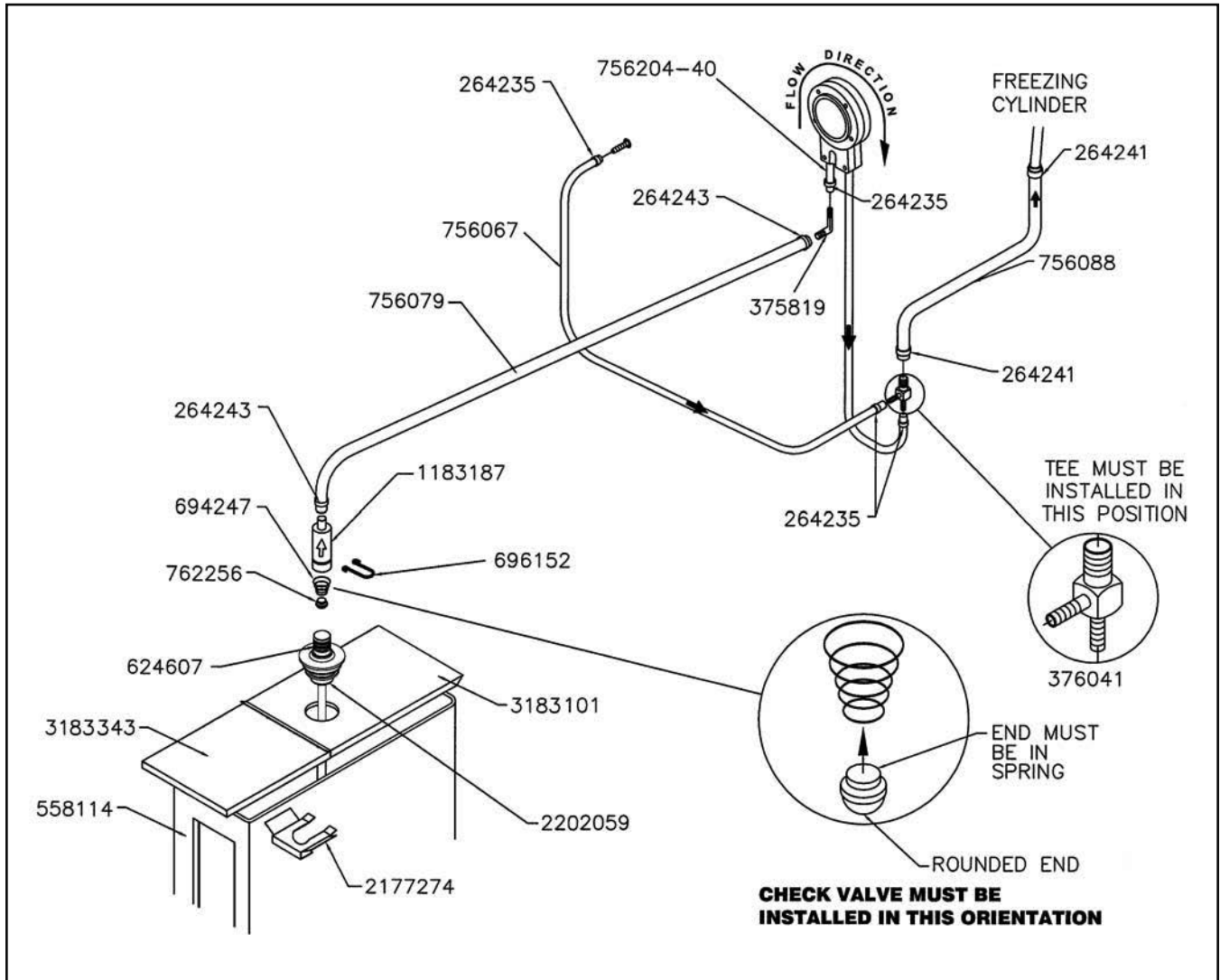

Part Number	Description	Quantity
264235	Clamp - Metal (1/4" ID Tubing)	10
264241	Clamp - Metal (1/2" ID Tubing)	4
264243	Clamp - Metal (3/8" ID Tubing)	4
375819	Elbow - Barbed (3/8"- 1/4")	2
376041	Tee Connector - 3-Way (Stainless)	2
558114	Mix Container Only	2
624607-5	O-Ring - Check Valve Body - Black (5 Pack)	2
694247	Spring - Cone (Cab Check Valve)	2
696152	Clip - Lock (Check Valve)	2
756067	Tubing - 1/4" ID - Clear - Air Line (25' Increments) (Per Inch)	Two 7" & Two 9"
756079	Tubing - 3/8" ID - Clear - Mix Line (25' Increments) (Per Inch)	Two 24"
756088	Tubing - 1/2" ID - Clear - Mix Line (25' Increments) (Per Inch)	Two 6"
756204	Tubing - 1/4" ID - Pump (50' Box Only) (Per Inch)	-
756204-40	Tubing - 1/4" ID - Pump (Pre-Cut 40" Piece)	2
762256	Check Valve - Mix Outlet	2
1183187	Check Valve - Mix In Line	2
2177274	Clip - Retaining (Mix Probe To Cover)	2
2202059	Pick-Up Tube - Mix	2
3183101	Cover - Rear (Mix Container)	2
3183343	Cover - Front (Mix Container)	2



**1. Scope:**

Stoelting, A Vollrath Company (“Stoelting”) warrants to the first user (the “Buyer”) that the Stoelting-branded freezer equipment (the “Equipment”) will be free from defects in materials and workmanship under normal use and proper maintenance for the period listed below in the Warranty Period section. All warranty periods begin on the date of original install or one (1) year from the shipping date, whichever occurs first. This warranty is subject to all conditions, exceptions, and limitations contained herein.

**2. Disclaimer of Other Warranties:**

**THIS WARRANTY IS EXCLUSIVE; AND STOELTING HEREBY DISCLAIMS ANY IMPLIED WARRANTY OF MERCHANTABILITY OR FITNESS FOR PARTICULAR PURPOSE.**

**3. Remedies:**

Stoelting’s sole obligations, and Buyer’s sole remedies, for any breach of this warranty shall be, at Stoelting’s option, one of the following: repair or replacement of the affected component at Stoelting’s plant in Kiel, Wisconsin, or refund of the purchase price of the affected Equipment. Stoelting, through an Authorized Stoelting Provider, will deinstall/reinstall the affected component from/into the equipment (“Labor”) for the period listed below in the Warranty Period section. These obligations/remedies are subject to the conditions that Buyer (a) signs and returns to Stoelting, upon installation, the Start-Up and Training Checklist for the affected equipment, (b) gives Stoelting prompt written notice of any claimed breach of warranty within the applicable warranty period, and (c) delivers the affected equipment to Stoelting or its designated service location, in its original packaging/crating, also within that period. Buyer shall bear the cost and risk of shipping to and from Stoelting’s plant or designated service location.

**4. Warranty Period:**

Equipment	Part	Part Warranty Period	Labor Warranty Period
Soft Serve & Shake	Freezing Cylinders	Five (5) Years	Twelve (12) Months
	Hoppers		
	Compressors		
	Drive Motors		
	Speed Reducers		
	Augers		
Frozen Uncarbonated Beverage	Evaporator	Five (5) Years	Twelve (12) Months
	Compressors		
	Drive Motors		
	Speed Reducers		
Custard & Batch	Freezing Cylinders	Two (2) Years	Twelve (12) Months
	Hoppers		
	Compressors		
	Drive Motors		
	Speed Reducers		
	Beaters Auger Shafts		
Dipping Cabinets & Display Cabinets	All components	Twelve (12) Months	Twelve (12) Months
Frozen Beverage / Granita Dispenser	Compressors	Five (5) Years	Twelve (12) Months
	Electronic Board	Three (3) Years	
	All other components	Two (2) Years	
AutoVend	All components	Twelve (12) Months	Twelve (12) Months
Crème Whippers	Compressors	Two (2) Years	Twelve (12) Months
	Motors		
	Condensers		
All equipment	All other components not specified above	Twelve (12) Months	Twelve (12) Months

5. **Conditions:**

- a) If the date of the original installation cannot be verified, these warranty periods begin one (1) year from the shipping date. It is the responsibility of the seller to disclose this information to the Buyer at the time of sale.
- b) Stoelting shall not be responsible to provide any remedy under this warranty with respect to any component that fails by reason of negligence, abnormal use, misuse or abuse, faulty repair made by others, use with parts or equipment not manufactured or supplied by Stoelting, any modification or alteration of any parts or equipment, or damage in transit.
- c) This warranty is valid only if the Equipment is installed and serviced by an Authorized Stoelting Provider and only if new, genuine Stoelting parts are used.
- d) The Equipment installation location must have suitable conditions as explained in the Stoelting operators manual, specification sheet, and/or technical manual including but not limited to, ambient temperature, water supply parameters, and space requirements.
- e) The Authorized Stoelting Provider must return defective parts, at Stoelting's discretion, for credit.
- f) Any refrigerant other than that specified on the Equipment model identification nameplate voids this warranty.

6. **Exceptions:**

This warranty does **NOT** cover any of the following

- a) Costs associated with installation labor, disposal of equipment being replaced, and shipping costs of replacement parts or Equipment.
- b) Cleaning, maintenance or lubrication of the Equipment as outlined in the Stoelting operators manual.
- c) This warranty does not extend to parts, sometimes called "wear parts", which are generally expected to deteriorate and to require replacement as equipment is used, including but limited to o-rings, auger flights, auger seals, auger support bushings, and drive belts. All such parts are sold **AS IS**.
- d) External components including but not limited to hoses, piping, or electrical equipment.
- e) Labor and travel charges due to return trips or waiting if the Authorized Stoelting Provider is prevented from promptly starting service work upon arrival. This exception includes labor charges incurred for limited access facilities including, but not limited to, government and military buildings, and airports.
- f) Failure, damage, or repairs due to faulty installation, misapplication, abuse, lack of service, or improper service, unauthorized alteration, improper operation as indicated in the Stoelting operators manual, including but not limited to failure to properly assemble and/or clean, improper tool usage, or use of unapproved lubrication, or cleaning and sanitizing supplies.
- g) Any costs associated with electricity, including utility increases, from any reason whatsoever.
- h) Damage resulting from the use of refrigerant other than that specified on the Equipment model identification nameplate.
- i) The use of this equipment as a rental asset negates all warranties associated with the equipment.
- j) Any special, indirect or consequential property or commercial damage of any nature whatsoever, if the jurisdiction allows this exclusion.
- k) Costs not covered by the Stoelting Travel Pay policy. Stoelting covers only the first trip travel which is a flat rate by mileage one-way from the service company's home location to the job site. The flat rate is calculated as follows:
  - o 0-50 Miles \$85
  - o 51-110 Miles \$127
  - o 111-160 Miles \$165
  - o Over 160 Miles The maximum reimbursed by Stoelting is \$165

Any travel costs not covered may be invoiced to the customer.

7. **Limitations:**

**THE REMEDIES SET FORTH IN THIS WARRANTY SHALL BE THE SOLE LIABILITY STOELTING AND THE EXCLUSIVE REMEDY OF BUYER WITH RESPECT TO EQUIPMENT SUPPLIED BY STOELTING; AND IN NO EVENT SHALL STOELTING BE LIABLE FOR ANY INCIDENTAL OR CONSEQUENTIAL DAMAGES, INCLUDING AS EXAMPLES BUT NOT INTENDED TO BE LIMITED TO DOWNTIME, OVERHEAD, MATERIALS, PERFORMANCE PENALTIES, LOST SALES, LOST PROFITS, PRODUCT LOSS, OR PROPERTY DAMAGES, WHETHER FOR BREACH OF WARRANTY OR OTHER CONTRACT BREACH, NEGLIGENCE OR OTHER TORT, OR ON ANY STRICT LIABILITY THEORY.**