



ADA Compliant

This Space for Architect/Engineer Approval

Job Name _____ Date _____

Model Specified _____ Quantity _____

Customer/Wholesaler _____

Contractor _____

Architect/Engineer _____

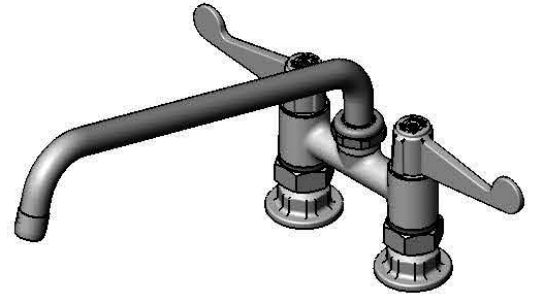
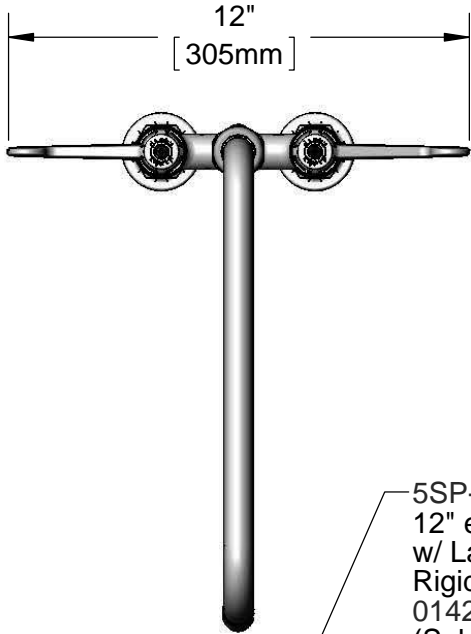

5SP-12
12" equip Swing Nozzle
w/ Laminar Flow Device.
Rigid Conversion Requires
014200-45 Lock Washer
(Sold Separately)

Ceramic Cartridges &
equip 4" Wrist Action Handles
w/ Color Coded Screws

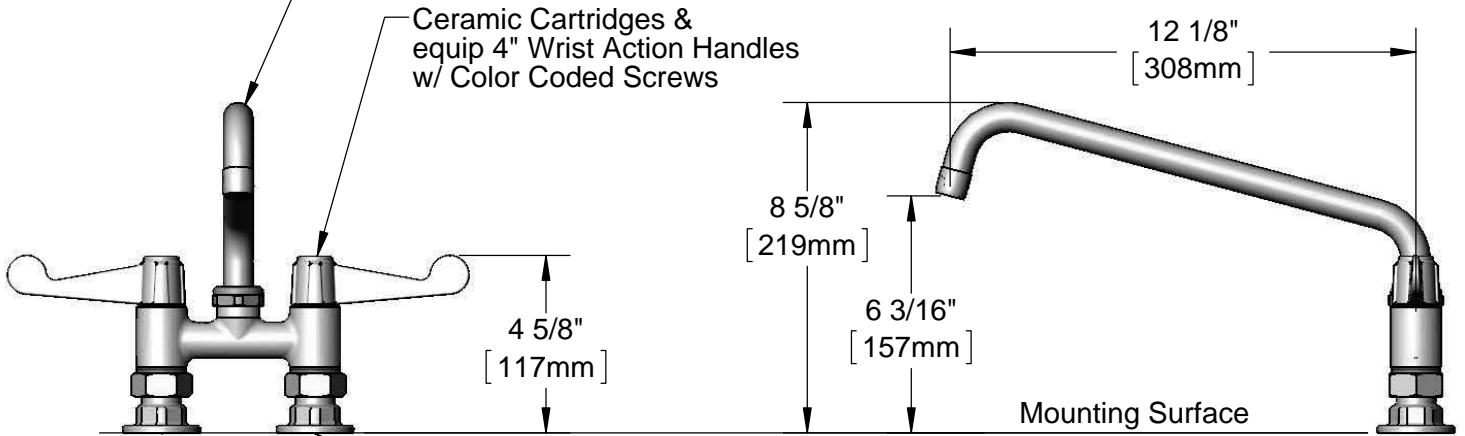

4"
[102mm]
Adjustable from
3 3/4" to 4 1/4"
[95mm to 108mm]

Ø 2" [51mm]
Flanges w/
1/2" NPT
Female Inlets

Mounting Surface



Model Number
5F-4DWX12

Date
09/19/12

Scale
1:5

Drawn
KJG

Checked
DHL

Approved
JHB



Product Specifications:

4" Deck Mount Mixing Faucet w/ Ceramic Cartridges,
equip 4" Wrist Action Handles, 12" equip Swing Nozzle
& 1/2" NPT Female Inlets

equip Foodservice Accessories
2 Saddleback Cove, P.O. Box 1088
Travelers Rest, South Carolina 29690
Phone: 800.891.4808 Fax: 800.868.0084

ITEM NO.	SALES NO.	DESCRIPTION
1	014250-45	Laminar Flow Device
2	5SP-12	12" equip Swing Nozzle
3	013839-25	Swivel Nut
4	013848-45	equip Swivel Piece O-Ring
5	5-HDL-W	equip 4" Wrist Action Handle w/ Color Coded Screws
6	013788-45	Ceramic Cartridge, LTC
7	001019-45	Coupling Nut Washer
8	00AA	1/2" NPT Inlet Flange
9	013787-45	Ceramic Cartridge, RTC

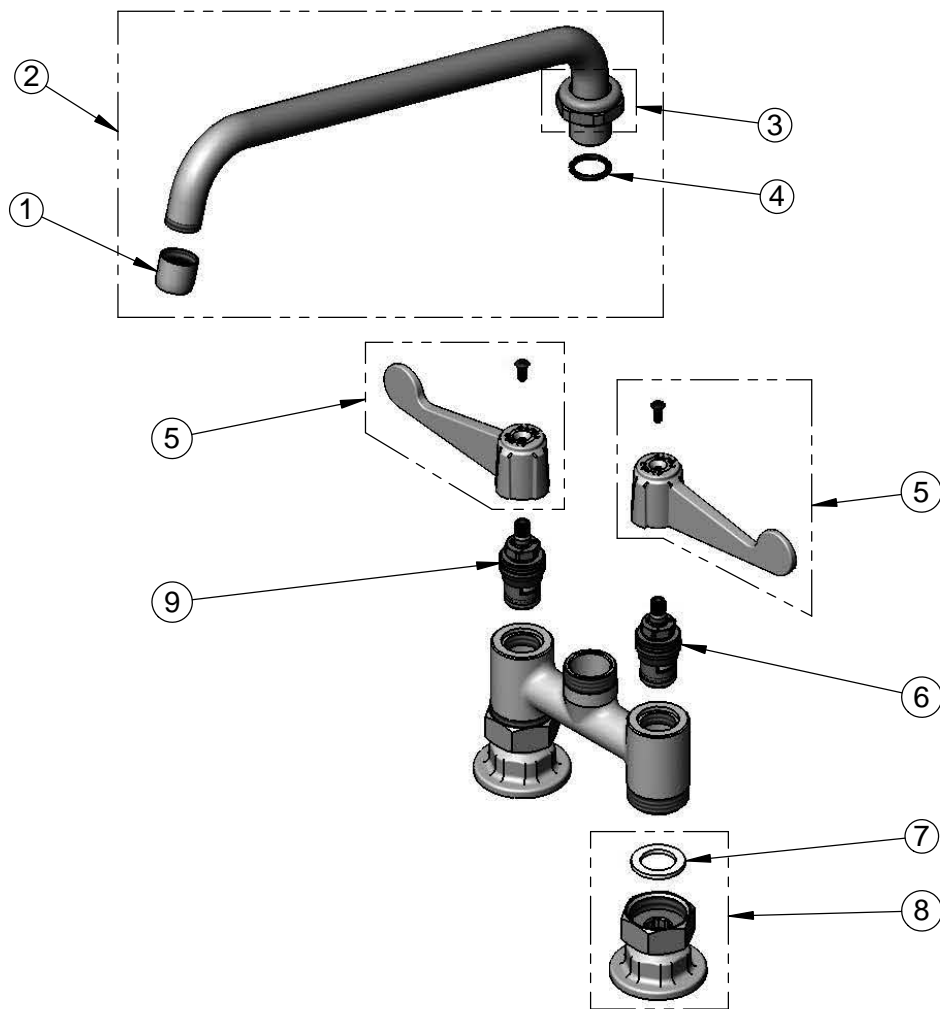

Model Number
5F-4DWX12

Date
09/19/12

Scale
NTS

Drawn
KJG

Checked
DHL

Approved
JHB



Product Specifications:

4" Deck Mount Mixing Faucet w/ Ceramic Cartridges,
equip 4" Wrist Action Handles, 12" equip Swing Nozzle
& 1/2" NPT Female Inlets

equip Foodservice Accessories
2 Saddleback Cove, P.O. Box 1088
Travelers Rest, South Carolina 29690
Phone: 800.891.4808 Fax: 800.868.0084