

ADA Compliant

This Space for Architect/Engineer Approval

Job Name _____ Date _____

Model Specified _____ Quantity _____

Customer/Wholesaler _____

Contractor _____

Architect/Engineer _____

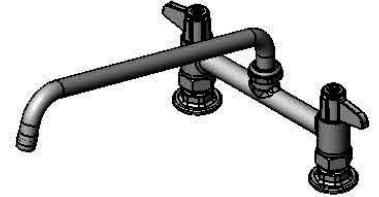

5SP-14
14" equip Swing Nozzle
w/ Laminar Flow Device.
Rigid Conversion Requires
014200-45 Lock Washer
(Sold Separately)

Ceramic Cartridges &
equip Lever Handles
w/ Color Coded Screws

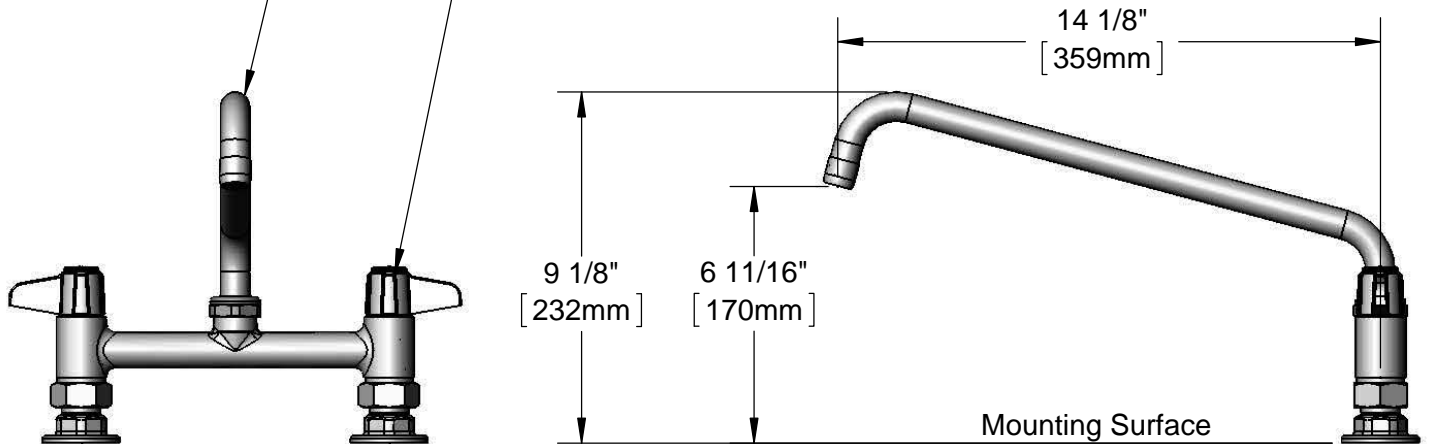

8"
[203mm]
Adjustable From
7 3/4" to 8 1/4"
[197mm to 210mm]

Ø 2" [51mm]
Flanges w/
1/2" NPT
Female Inlets

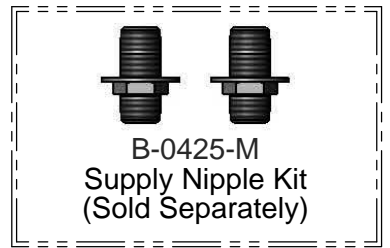

Model Number 5F-8DLX14	Date 06/05/12	Scale 1:4	Drawn DHL	Checked DMH	Approved JHB
---------------------------	------------------	--------------	--------------	----------------	-----------------

Product Specifications:
**8" Deck Mount Mixing Faucet w/ Ceramic Cartridges,
equip Lever Handles, 14" equip Swing Nozzle
& 1/2" NPT Female Inlets**



equip Foodservice Accessories
2 Saddleback Cove, P.O. Box 1088
Travelers Rest, South Carolina 29690
Phone: 800.891.4808 Fax: 800.868.0084

ITEM NO.	SALES NO.	DESCRIPTION
1	014250-45	Laminar Flow Device
2	5SP-14	14" equip Swing Nozzle
3	013839-25	equip Swivel Nut
4	013848-45	equip Swivel Piece O-ring
5	5-HDL-L	equip Lever Handle w/ Color Coded Screws
6	013788-45	equip Ceramic Cartridge, LTC
7	001019-45	Coupling Nut Washer
8	00AA	1/2" NPT Inlet Flange
9	013787-45	equip Ceramic Cartridge, RTC

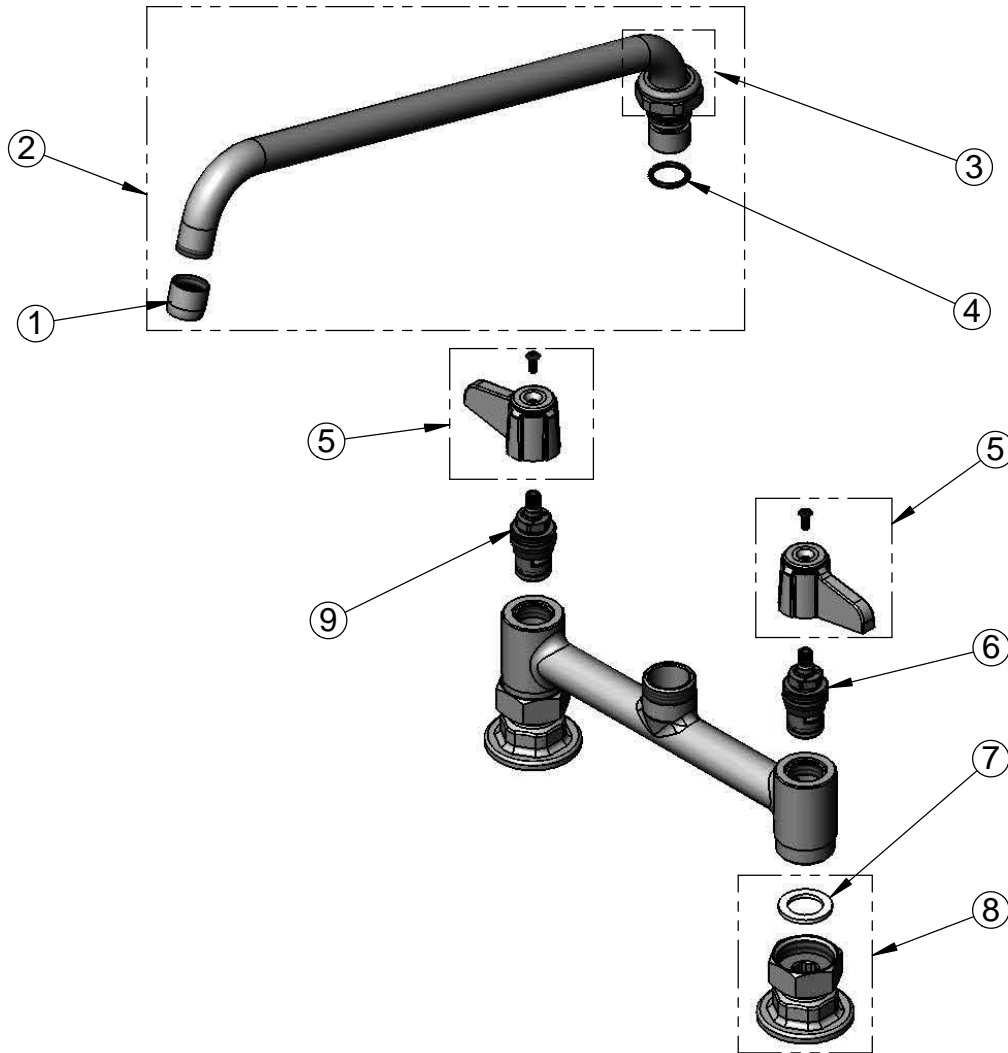

Model Number 5F-8DLX14	Date 06/05/12	Scale NTS	Drawn DHL	Checked DMH	Approved JHB
---------------------------	------------------	--------------	--------------	----------------	-----------------



Product Specifications:

**8" Deck Mount Mixing Faucet w/ Ceramic Cartridges,
equip Lever Handles, 14" equip Swing Nozzle
& 1/2" NPT Female Inlets**

equip Foodservice Accessories
2 Saddleback Cove, P.O. Box 1088
Travelers Rest, South Carolina 29690
Phone: 800.891.4808 Fax: 800.868.0084