



T&S BRASS AND BRONZE WORKS, INC.
 2 Saddleback Cove / P.O. Box 1088
 Travelers Rest, SC 29690

Model No.
B-0133-A-08C SERIES

Item No.

Travelers Rest, SC: 800-476-4103 • Simi Valley, CA: 800-423-0150 • Fax: 864-834-3518 • www.tsbrass.com

This Space for Architect/Engineer Approval

Job Name _____ Date _____

Model Specified _____ Quantity _____

Customer/Wholesaler _____

Contractor _____

Architect/Engineer _____

Model	Swing Nozzle	D	K	H	6" Wall Bracket
B-0133-A06-08C	059X	6"	7 7/16"	10 1/8"	No
B-0133-A06-B08C	059X	6"	7 7/16"	10 1/8"	Yes
B-0133-A08-08C	060X	8"	8"	10 3/4"	No
B-0133-A08-B08C	060X	8"	8"	10 3/4"	Yes
B-0133-A10-08C	061X	10"	8 3/4"	11 7/16"	No
B-0133-A10-B08C	061X	10"	8 3/4"	11 7/16"	Yes
B-0133-A12-08C	062X	12"	9 3/8"	12 1/8"	No
B-0133-A12-B08C	062X	12"	9 3/8"	12 1/8"	Yes

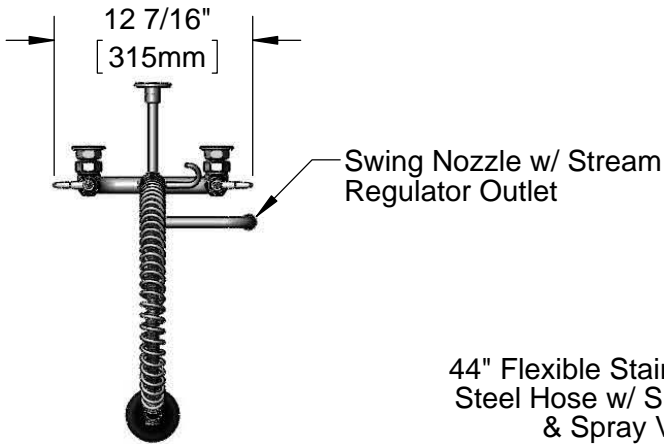

44" Flexible Stainless Steel Hose w/ Spring & Spray Valve

Items Not Shown for Clarity

Finger Hook

3/8" NPT x 18" Riser

D

H

K

Eterna Cartridges w/ Spring Checks & Lever Handles w/ Color Coded Indexes

8"

[203mm]

Adjustable From 7 3/4" to 8 1/4"

[197mm to 210mm]

B-0108-C
0.65 GPM
Fan Spray
Valve



9 5/8"

[245mm]

2 5/16"

[59mm]

B-0109-01
6" Wall Bracket
(Optional)

EasyInstall
Add-On Faucet
w/ Eterna
Cartridge &
Lever Handle

Mounting
Surface

Ø 2" [51mm]
Flanges w/
1/2" NPT
Female Inlets

14 7/16"

[366mm]

37 9/16"

[954mm]

Product Specifications:

EasyInstall Pre-Rinse Unit:
 8" Wall Mount Mixing Faucet, Eterna Cartridges w/ Spring Checks,
 Lever Handles, 44" Flexible Stainless Steel Hose, 0.65 GPM Spray
 Valve, 18" Riser, 6" Wall Bracket (Optional) & 1/2" NPT Female Inlets

Product Compliance:

ASME A112.18.1 / CSA B125.1
 NSF 61 - Section 9
 NSF 372 (Low Lead Content)
 EPA Act 2005 (PRSV)
 EPA WaterSense (PRSV)



T&S BRASS AND BRONZE WORKS, INC.

2 Saddleback Cove / P.O. Box 1088
Travelers Rest, SC 29690

Model No.
B-0133-A-08C SERIES

Item No.

Travelers Rest, SC: 800-476-4103 • Simi Valley, CA: 800-423-0150 • Fax: 864-834-3518 • www.tsbrass.com

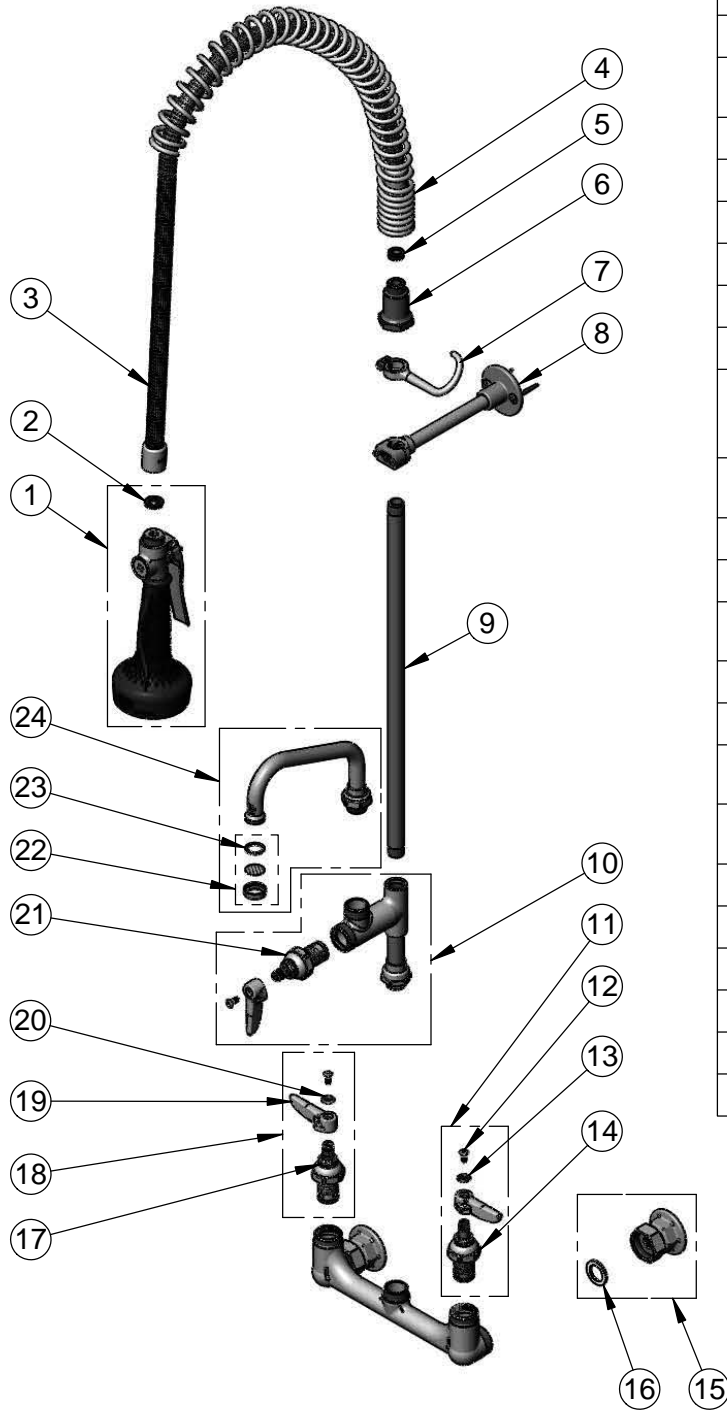

ITEM NO.	SALES NO.	DESCRIPTION
1	B-0108-C	0.65 GPM Spray Valve w/ Ergo-Grip
2	001014-45	Washer, B-0100 Hose Barrel
3	B-0044-H2A	44" Flexible Stainless Steel Hose - Less Handle
4	000888-45	EasyInstall Overhead Spring
5	010476-45	#27 Washer
6	000821-40	Spring Body
7	004R	Finger Hook
8	B-0109-01	6" Wall Bracket
9	000369-40	3/8" NPT x 18" Riser
10	B-0155-LNEZ	Add-On Faucet w/ 1/4 Turn Eterna Cartridge, RTC & Lever Handle (Less Nozzle)
11	002711-40	Eterna Cartridge, LTC w/ Spring Check, Handle, Index & Screw
12	000922-45	Lever Handle Screw
13	001660-45	Blue Index-CW
14	012442-40	Eterna Cartridge, LTC w/ Spring Check
15	00AA	1/2" NPT Female Eccentric Flange
16	001019-45	Coupling Nut Washer
17	012443-40	Eterna Cartridge, RTC w/ Spring Check
18	002712-40	Eterna Cartridge, RTC w/ Spring Check, Handle, Index & Screw
19	001638-45	Lever Handle
20	001661-45	Red Index-HW
21	005960-40QT	1/4 Turn Eterna Cartridge, RTC
22	B-PT	Stream Regulator Outlet
23	001048-45	Nozzle Tip Washer
24	See Chart	Swing Nozzle

Product Specifications:

EasyInstall Pre-Rinse Unit:
8" Wall Mount Mixing Faucet, Eterna Cartridges w/ Spring Checks,
Lever Handles, 44" Flexible Stainless Steel Hose, 0.65 GPM Spray
Valve, 18" Riser, 6" Wall Bracket (Optional) & 1/2" NPT Female Inlets

Product Compliance:

ASME A112.18.1 / CSA B125.1
NSF 61 - Section 9
NSF 372 (Low Lead Content)
EPA Act 2005 (PRSV)
EPA WaterSense (PRSV)