



**T&S BRASS AND BRONZE WORKS, INC.**  
 2 Saddleback Cove / P.O. Box 1088  
 Travelers Rest, SC 29690

Model No.  
**B-1436-MV-CR-QD**

Item No.

Travelers Rest, SC: 800-476-4103 • Simi Valley, CA: 800-423-0150 • Fax: 864-834-3518 • www.tsbrass.com

This Space for Architect/Engineer Approval

Job Name \_\_\_\_\_ Date \_\_\_\_\_

Model Specified \_\_\_\_\_ Quantity \_\_\_\_\_

Customer/Wholesaler \_\_\_\_\_

Contractor \_\_\_\_\_

Architect/Engineer \_\_\_\_\_

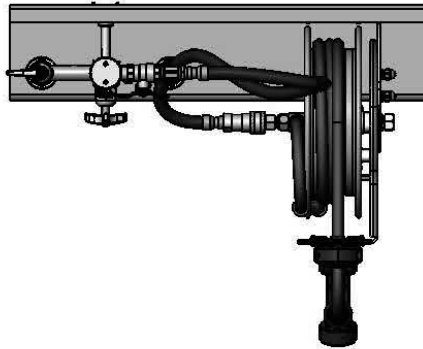

Stainless Steel Backplate

Wall Bracket

3/8" NPT x 12" Risers

Control Valve

8" Deck Mount Mixing Faucet, Quarter-Turn Cerama Cartridges w/ Check Valves & Lever Handles w/ Color Coded Indexes

3/8" NPT x 24" Flexible Water Connector

B-0963 Continuous Pressure Vacuum Breaker w/ Integral Check Valve

Open Stainless Steel Hose Reel w/ 15' of 3/8" Hose w/ Stainless Steel Quick Disconnect

18" [457mm] Typ

Stainless Steel Quick Disconnect

MV-2516-24 Stainless Steel Rear Trigger Water Gun, 5/16" Orifice

1/2" NPT Male Supply Nipples

40 1/8" [1019mm]

4 1/4" [108mm]

6" [152mm]

8" [203mm] Typ

8" [203mm]

26" [660mm]

**Product Specifications:**

Open Stainless Steel Hose Reel w/ 15' of 3/8" Hose on Stainless Steel Backplate, Quick Disconnect, Stainless Steel Rear Trigger Water Gun, Vacuum Breaker, 3/8" NPT Flexible Water Connector, 8" Deck Mount Mixing Faucet & Control Valve

**Product Compliance:**

NSF 61 Exempt (Non-Potable)  
 EPA Act 2005 Non-Compliant (PRSV)  
 ASSE 1056 (VB)



**T&S BRASS AND BRONZE WORKS, INC.**  
 2 Saddleback Cove / P.O. Box 1088  
 Travelers Rest, SC 29690

Model No.  
**B-1436-MV-CR-QD**

Item No.

Travelers Rest, SC: 800-476-4103 • Simi Valley, CA: 800-423-0150 • Fax: 864-834-3518 • www.tsbrass.com

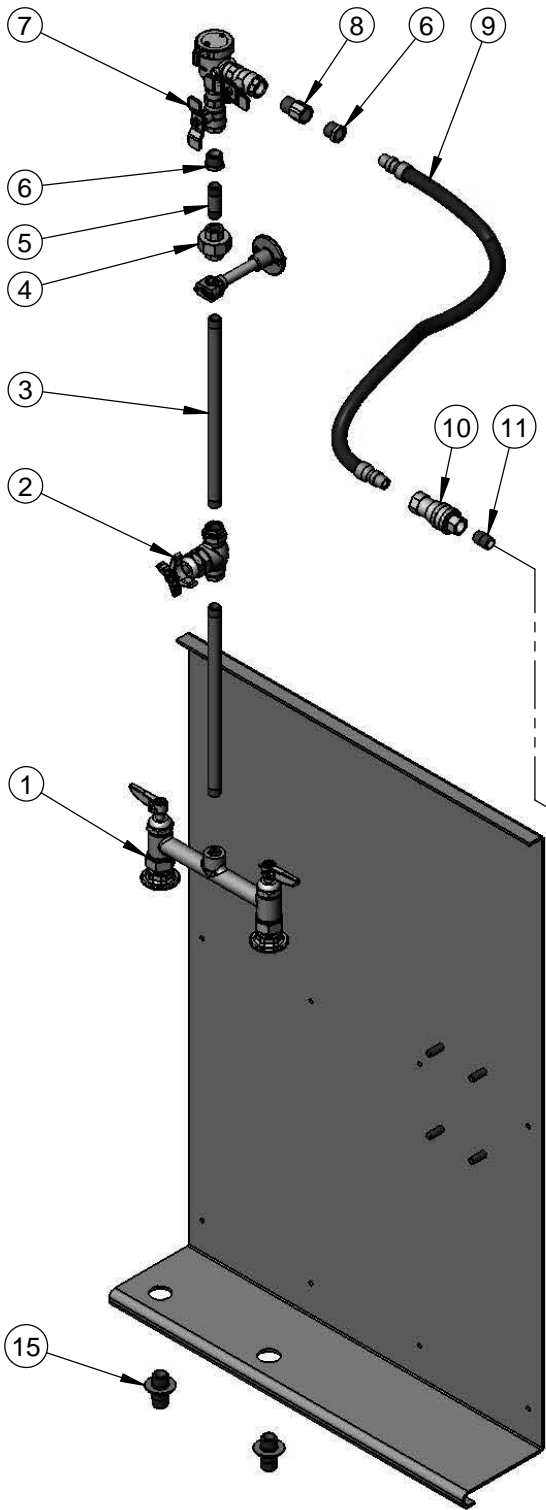

ITEM NO.	SALES NO.	DESCRIPTION
1	019003-40	8" Deck Mount Faucet, Quarter-Turn Cerama Cartridges w/ Check Valves
2	0RK3	Control Valve
3	145X	3/8" NPT x 12" Riser
4	002475-40	3/8" NPT Union
5	000357-40	3/8" NPT x 2" Nipple
6	001359-40	1/2" NPT Male x 3/8" NPT Female Hex Bushing
7	B-0963	1/2" NPT Continuous Pressure VB w/ Integral Check Valve
8	015073-40	Check Valve w/ 1/2" NPT Adapter
9	HW-2B-24	3/8" NPT x 24" Flexible Water Hose
10	AW-5B	3/8" NPT Quick Disconnect
11	002535-25	3/8" NPT Close Nipple
12	AW-5B	3/8" NPT Quick Disconnect
13	062A	1/2" NPT Male x 3/8" NPT Male Adapter
14	MV-2516-24	Rear Trigger Gun, 5/16" Orifice
15	B-0425-M	1/2" NPT Supply Nipple Kit, (2)

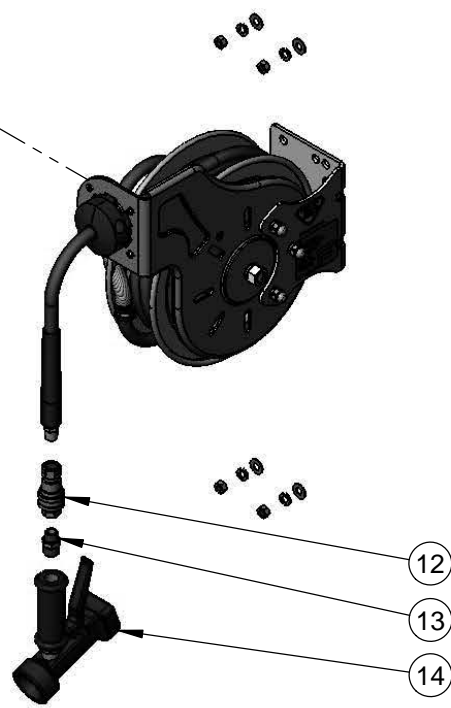

**Product Specifications:**

Open Stainless Steel Hose Reel w/ 15' of 3/8" Hose on Stainless Steel Backplate, Quick Disconnect, Stainless Steel Rear Trigger Water Gun, Vacuum Breaker, 3/8" NPT Flexible Water Connector, 8" Deck Mount Mixing Faucet & Control Valve

**Product Compliance:**

NSF 61 Exempt (Non-Potable)  
 EPA Act 2005 Non-Compliant (PRSV)  
 ASSE 1056 (VB)