



**T&S BRASS AND BRONZE WORKS, INC.**  
 2 Saddleback Cove / P.O. Box 1088  
 Travelers Rest, SC 29690

Model No.  
**BF-0299-10**

Item No.

Travelers Rest, SC: 800-476-4103 • Simi Valley, CA: 800-423-0150 • Fax: 864-834-3518 • www.tsbrass.com

This Space for Architect/Engineer Approval

Job Name \_\_\_\_\_ Date \_\_\_\_\_  
 Model Specified \_\_\_\_\_ Quantity \_\_\_\_\_  
 Customer/Wholesaler \_\_\_\_\_  
 Contractor \_\_\_\_\_  
 Architect/Engineer \_\_\_\_\_



**ADA Compliant**

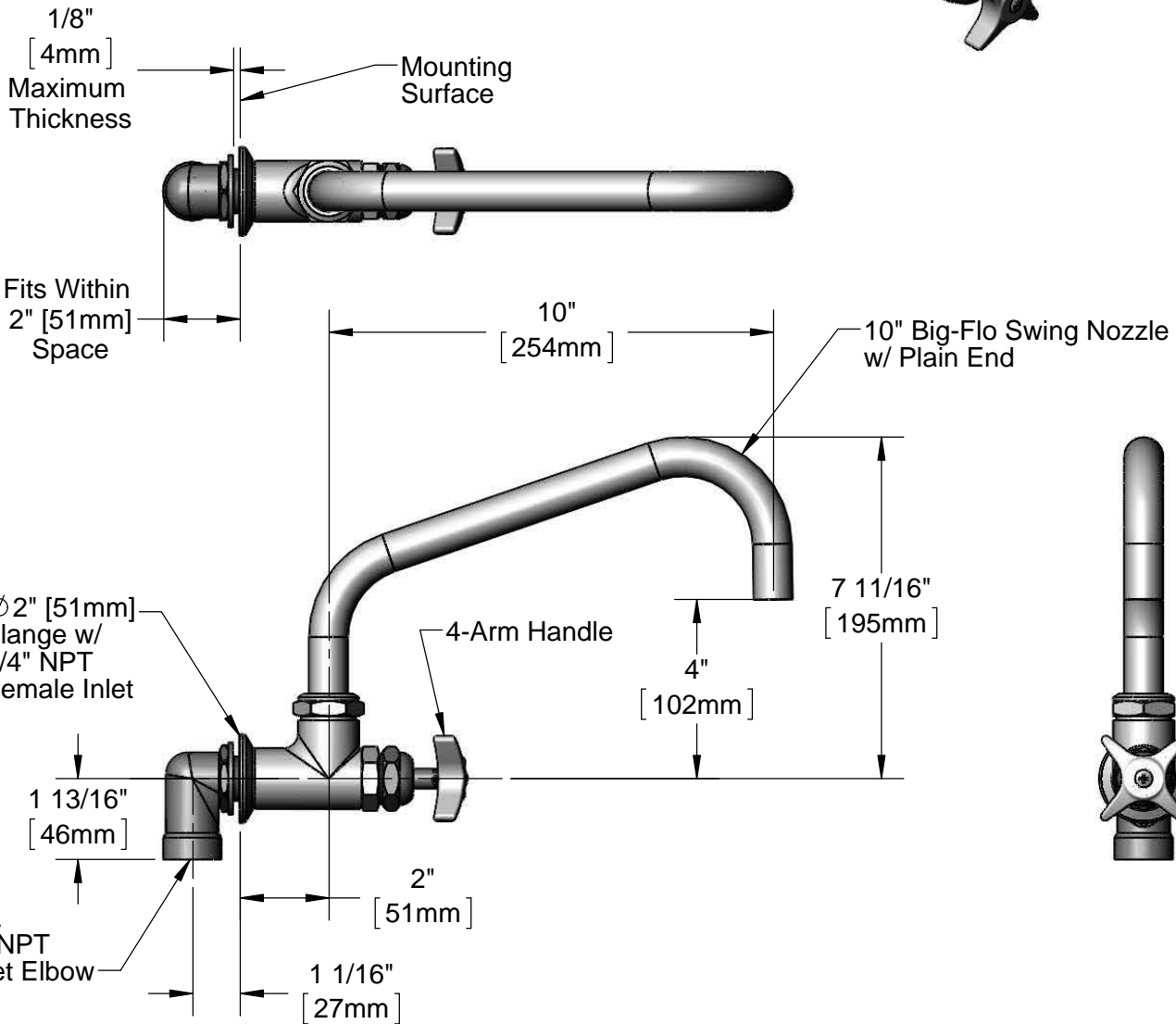
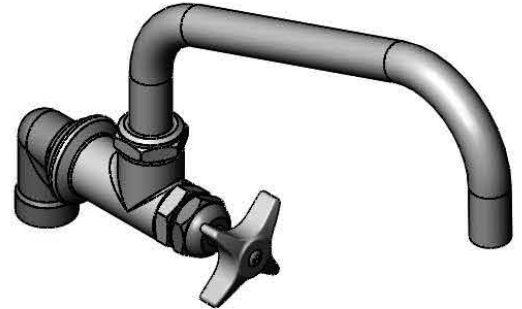

Rough-In Requirement:  
 Ø 1 1/4" [32mm] Hole

Product Specifications:  
 Single Wall Mount Big-Flo Faucet w/ 10" Plain End Swing Nozzle,  
 4-Arm Handle & 3/4" Street Elbow

Drawn <b>DMH</b>	Checked <b>JRM</b>	Approved <b>JHB</b>
Scale: <b>1:4</b>		Date: <b>10/18/12</b>



**T&S BRASS AND BRONZE WORKS, INC.**  
 2 Saddleback Cove / P.O. Box 1088  
 Travelers Rest, SC 29690

Model No.  
**BF-0299-10**

Item No.

Travelers Rest, SC: 800-476-4103 • Simi Valley, CA: 800-423-0150 • Fax: 864-834-3518 • www.tsbrass.com

ITEM NO.	SALES NO.	DESCRIPTION
1	112X	10" Big-Flo Swing Nozzle
2	001068-45	O-ring
3	000922-45	Lever Handle Screw
4	002521-45	4-Arm Handle
5	006482-40	Big-Flo Cartridge, RTC
6	000764-20	Seat, Big-Flo
7	00LL	3/4" Street Elbow Inlet

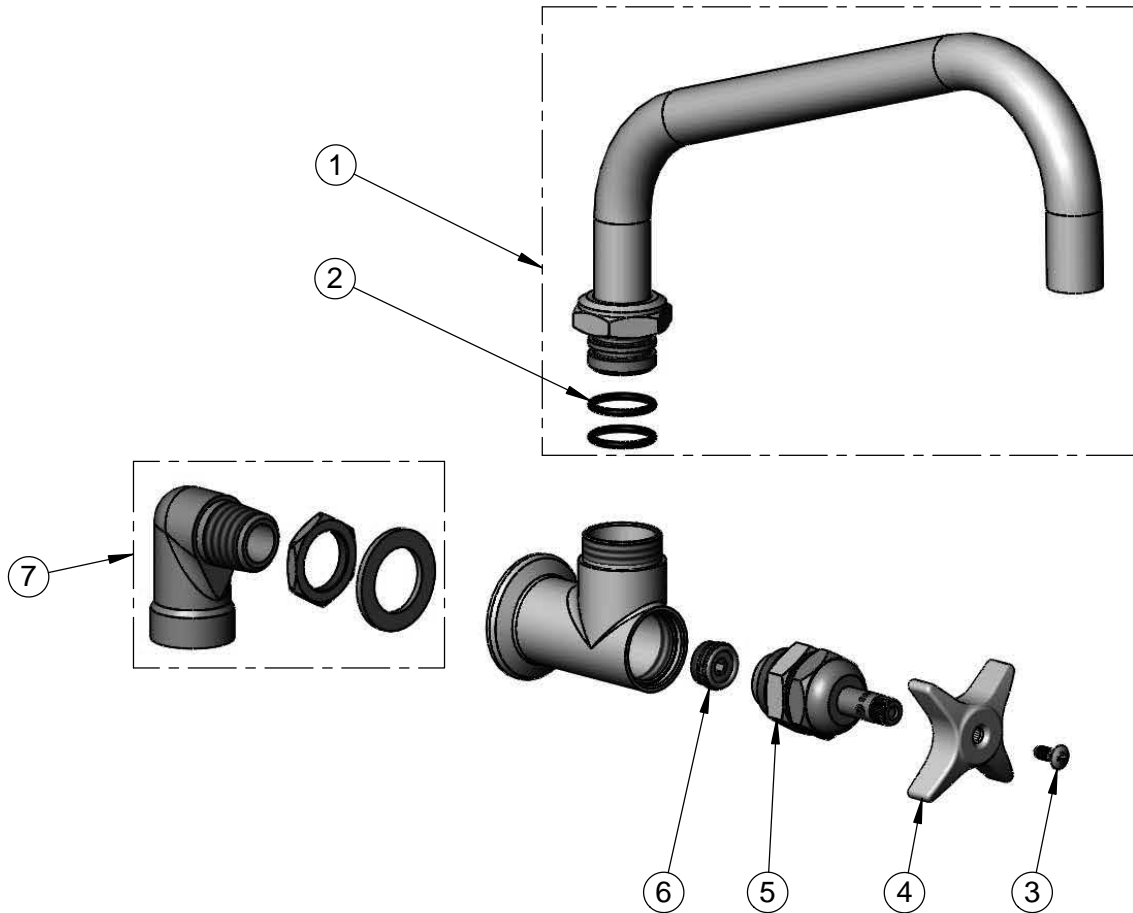

Product Specifications:  
 Single Wall Mount Big-Flo Faucet w/ 10" Plain End Swing Nozzle,  
 4-Arm Handle & 3/4" Street Elbow

Drawn <b>DMH</b>	Checked <b>JRM</b>	Approved <b>JHB</b>
Scale: <b>NTS</b>		Date: <b>10/18/12</b>