



SERVICE MANUAL



22157

G22010 MODEL SHOWN

TRAULSEN G SERIES FREEZER

G12000 Model Series

G22000 Model Series

G31300 Model Series

This Manual is prepared for the use of trained Hobart Service Technicians and should not be used by those not properly qualified.

This manual is not intended to be all encompassing. If you have not attended a Hobart Service School for this product, you should read, in its entirety, the repair procedure you wish to perform to determine if you have the necessary tools, instruments and skills required to perform the procedure. Procedures for which you do not have the necessary tools, instruments and skills should be performed by a trained Hobart Service Technician.

The reproduction, transfer, sale or other use of this Manual, without the express written consent of Hobart, is prohibited.

This manual has been provided to you by ITW Food Equipment Group LLC ("ITW FEG") without charge and remains the property of ITW FEG, and by accepting this manual you agree that you will return it to ITW FEG promptly upon its request at any time in the future.

TABLE OF CONTENTS

GENERAL	3
Introduction	3
Location	3
Operation	3
Cleaning	3
Tools	3
Control Panel	4
Specifications	4
REMOVAL AND REPLACEMENT OF PARTS	6
Covers & Panels	6
Cabinet Lamp	7
Intela-traul Control	8
Intela-traul Relay Module	8
Compressor Relay	9
Cabinet Air Sensor	9
Evaporator Coil Sensor	10
Thermal Expansion Valve	10
Evaporator Coil / Defrost Heater	11
Door Gasket	11
Door Assembly	12
Evaporator Fan	12
Condensing Unit Components	13
Hot Gas Condensate Pan	14
SERVICE PROCEDURES AND ADJUSTMENTS	15
Check Refrigerant Charge (Superheat, Sub Cooling & Split Temperatures)	15
Checking for Leaks	16
Evacuating System	17
Charging System	17
System Clean up	17
Software Version	18
Control Calibration	18
Control Parameters	19
Evaporator Coil Sensor Test	22
Cabinet Air Sensor Test	22
Cabinet Air, Cabinet Coil, & Sensor Resistance Test	22
Compressor Relay Test	22
Door Switch Test	22
ELECTRICAL OPERATION	23
Component Function	23
Sequence of Operation	24
Component Location	25
Wiring Diagrams	26
TROUBLESHOOTING	28

© Hobart 2010

GENERAL

INTRODUCTION

General

All G series freezers are Energy Star efficient and include a wide range of one, two, & three sectional reach in freezers. All models are capable of -10°F in up to 90°F ambient. The cabinets are equipped with anti-condensate door perimeter heaters.

These units aid in preserving food quality, texture and nutritional value.

All of the information, illustrations and specifications contained in this manual are based on the latest product information available at the time of printing.

LOCATION

Refer to the Installation Instructions for specific location requirements.

OPERATION

Refer to the Operation Manual for specific operating instructions.

CLEANING

Refer to the Operation Manual for specific cleaning instructions. The condenser coil must be cleaned every six months. This can be done with a vacuum cleaner using a fin comb or condenser coil brush.

TOOLS

- Standard set of hand tools
- Clamp meter Part No. 00-541069 Grainger No. 1ND81 or equivalent
- Grounding kit - Static Control Kit Grainger No. 4KK44
- Micro amp meter
- VOM with AC current tester (sensitivity of at least 20,000 ohms per volt)
- Refrigeration tool kit Part No. 00-913093-15
- Digital thermometer with quad inputs Model DT304 Part No. 00-913093-12
- Inficon D-Tek Select refrigerant leak detector Part No. 00-913093-2
- Vacuum Cleaner - Shop Vac
- Fin comb Grainger Part No. 2YJ78 or equivalent
- Condenser coil brush Grainger Part No. 3HHE8 or equivalent

CONTROL PANEL

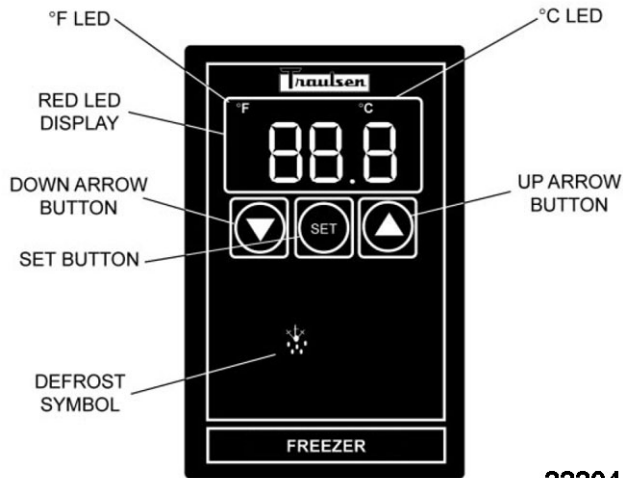

SPECIFICATIONS

DIMENSIONS	1 Section Cabinet	2 Section Cabinet	3 Section Cabinet
Height- overall on casters	83-1/4" (211.46cm)	83- 1/4" (211.46cm)	83- 1/4" (211.46cm)
Width	29- 7/8" (75.9cm)	52- 1/8" (132.4cm)	76- 5/16" (193.8cm)
Depth	35" (88.8cm)	35" (88.8cm)	35" (88.8cm)
Net Capacity cu. ft.	24.2	46.0	69.1

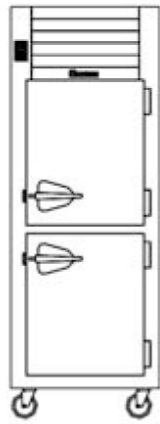

**FRONT VIEW
ONE SECTION
CABINET**

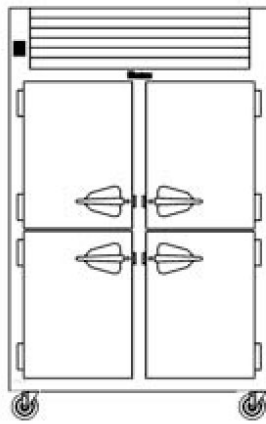

**FRONT VIEW
TWO SECTION
CABINET**

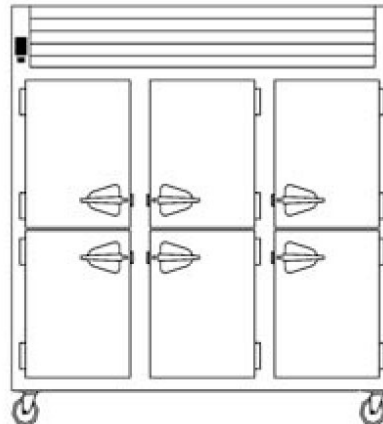

**FRONT VIEW
THREE SECTION
CABINET**

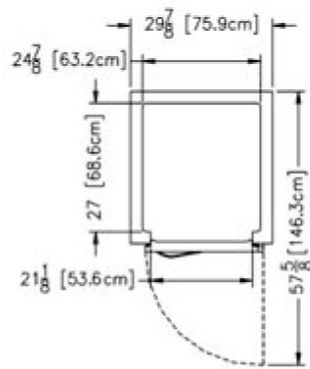

**TOP VIEW
ONE SECTION
CABINET**

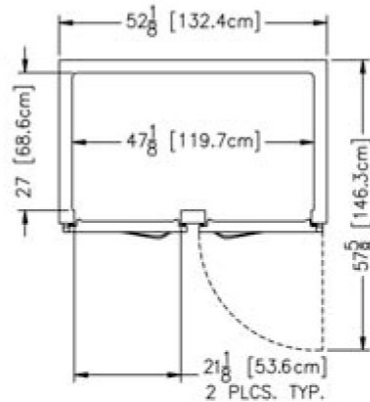

**TOP VIEW
TWO SECTION
CABINET**

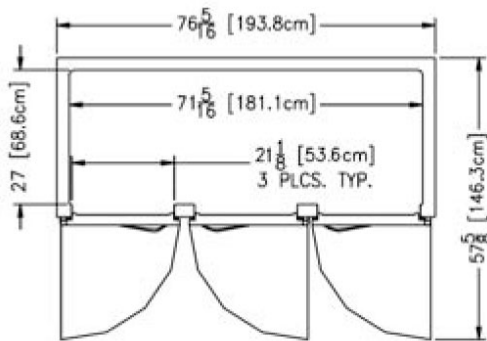

**TOP VIEW
THREE SECTION
CABINET**

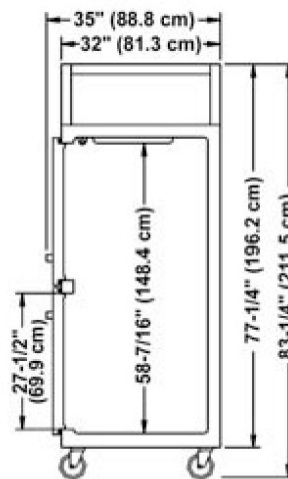

**SIDE VIEW
ALL CABINET SECTIONS**

22156

DATA	1 Section Cabinet	2 Section Cabinet	3 Section Cabinet	3 Section Cabinet
Voltage	115/60/1	115/60/1	115/60/1	208/60/1
Amps Full Load	9.5	11.2	16.0	11.0

OPERATING DATA	1 Section Cabinet	2 Section Cabinet	3 Section Cabinet
Refrigerant Type	R-404A	R-404A	R-404A
High Pressure (psi) 90°F Operating Temperature	500	500	500
Low Pressure (psi) 90°F Operating Temperature	250	250	250
BTU/HR (HP)	1930 @ -20°F Evaporator Temp. & 90°F Ambient (1/2HP)	2970 @ -20°F Evaporator Temp. & 90°F Ambient (3/4HP)	4710 @ -20°F Evaporator Temp. & 90°F Ambient (1HP)

REMOVAL AND REPLACEMENT OF PARTS

COVERS & PANELS

Front Panel



⚠ WARNING Disconnect the electrical power to the machine and follow lockout / tagout procedures. There may be multiple circuits. Be sure all circuits are disconnected.

1. Remove lower panel screws from cabinet.



2. Remove upper panel screws from cabinet.
- NOTE:** Upper panel screws are accessed from the back side of front panel.

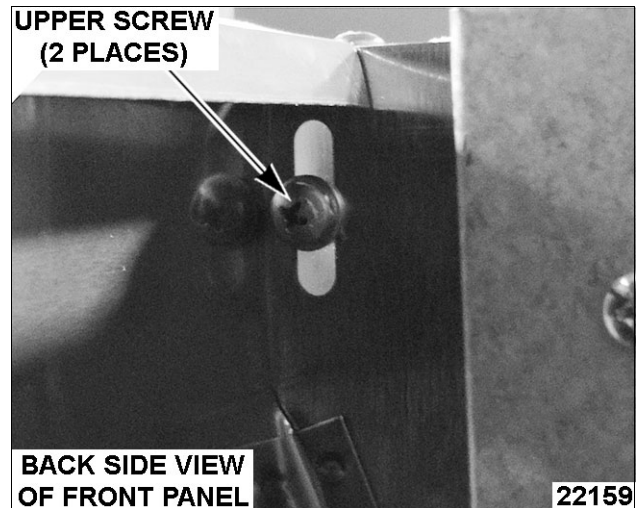

3. Remove panel from cabinet.
4. Reverse the procedure to install.

Condenser / Compressor Cover



⚠ WARNING Disconnect the electrical power to the machine and follow lockout / tagout procedures. There may be multiple circuits. Be sure all circuits are disconnected.

1. Access condenser cover at top of cabinet.
2. Remove all screws securing condenser cover to cabinet.



3. Lift cover from cabinet.
4. Reverse the procedure to install.

Evaporator Cover



⚠ WARNING Disconnect the electrical power to the machine and follow lockout / tagout procedures. There may be multiple circuits. Be sure all circuits are disconnected.

1. Access evaporator cover at top of cabinet.
2. Remove bolts securing evaporator cover to cabinet.



3. Use of a screw driver to aid in prying up cover to break adhesive seal then lift cover from cabinet.

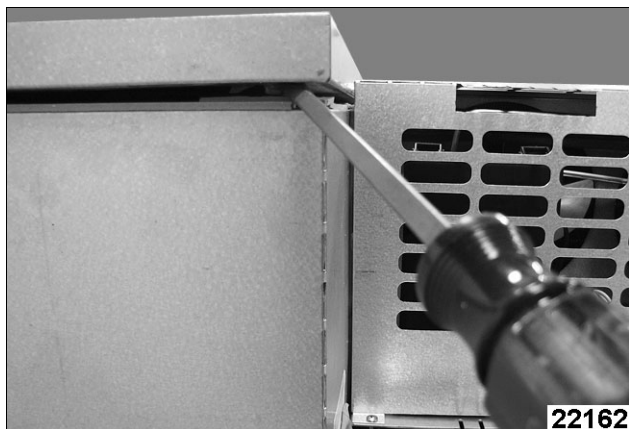

4. Reverse the procedure to install.
- NOTE:** Replace adhesive seal as needed.

Harness Raceway Cover

1. Access harness raceway cover at top of cabinet.
2. Remove screws securing cover to raceway housing.

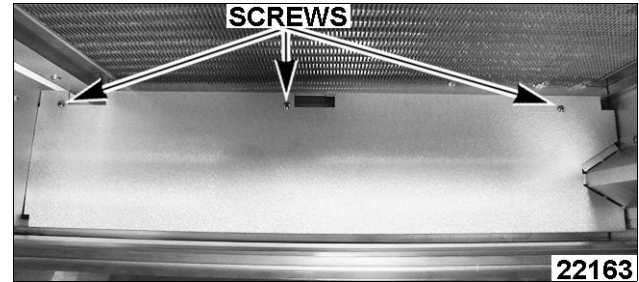

3. Lift cover up from raceway housing.
4. Reverse the procedure to install.

Control Box Cover

1. Access control box cover at top of cabinet.
2. Remove screws securing cover to cabinet.

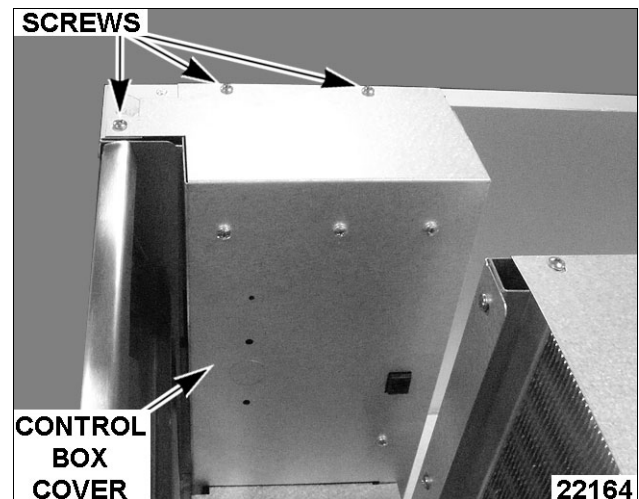

3. Lift cover up from control box.
4. Reverse the procedure to install.

CABINET LAMP



⚠ WARNING Disconnect the electrical power to the machine and follow lockout / tagout procedures. There may be multiple circuits. Be sure all circuits are disconnected.

1. Open cabinet door to gain access to cabinet light.
2. Reach up and carefully squeeze lamp lens inward to release lens from mounting tabs.

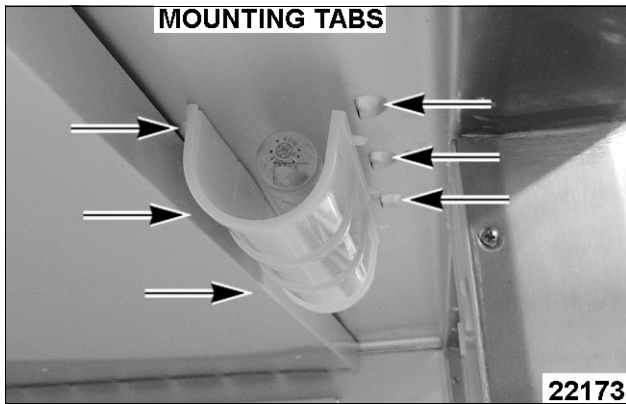

3. Remove lens from cabinet.
4. Turn lamp to remove from lamp socket.
5. Reverse the procedure to install.

INTELA-TRAUl CONTROL



⚠ WARNING Disconnect the electrical power to the machine and follow lockout / tagout procedures. There may be multiple circuits. Be sure all circuits are disconnected.

Removal

1. Remove front panel as outlined under COVERS & PANELS.
2. Access control at top of cabinet.
3. Remove control box cover as outlined under COVERS & PANELS.

NOTE: Use care not to damage lead wires.

4. Loosen screws securing harness connector to Inteltra-Traul Control.
5. Disconnect harness connector from Inteltra-Traul Control.

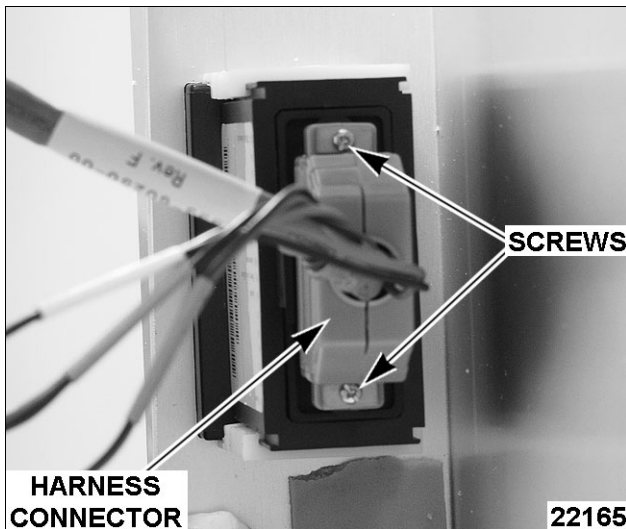

6. Compress in both sides of mounting clip, while sliding clip off Inteltra-Traul control. Repeat for

other mounting clip.

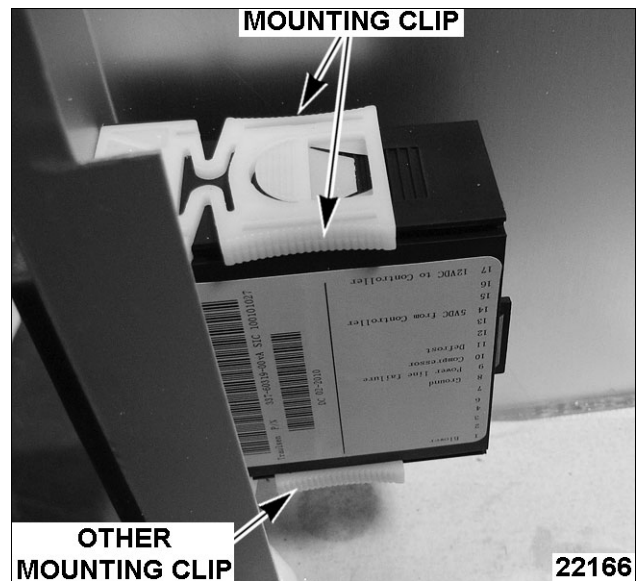

OTHER MOUNTING CLIP

7. Push Inteltra-Traul control out from front top panel.

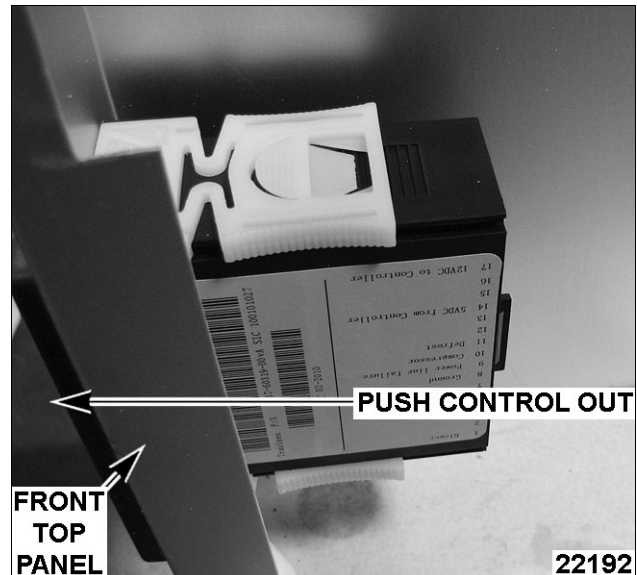

8. Reverse the procedure to install.

INTELA-TRAUl RELAY MODULE



⚠ WARNING Disconnect the electrical power to the machine and follow lockout / tagout procedures. There may be multiple circuits. Be sure all circuits are disconnected.

Removal

1. Remove front panel as outlined under COVERS & PANELS.
2. Access Inteltra-Traul relay module at top of cabinet.
3. Remove control box cover as outlined under COVERS & PANELS.

NOTE: Use care not to damage lead wires.

4. Disconnect all lead wire connectors from Intela-Traul relay box.
5. Remove both nuts securing Intela-Traul relay module to control box cover.

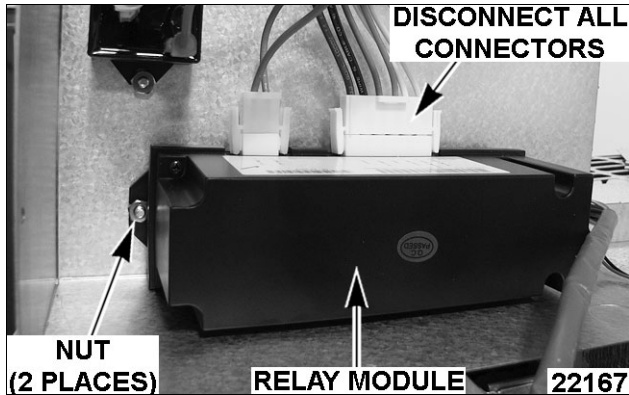

6. Reverse the procedure to install.

COMPRESSOR RELAY



⚠ WARNING Disconnect the electrical power to the machine and follow lockout / tagout procedures. There may be multiple circuits. Be sure all circuits are disconnected.

1. Remove front panel as outlined under COVERS & PANELS.
2. Access compressor relay at top of cabinet.
3. Remove control box cover as outlined under COVERS & PANELS.
4. Disconnect all lead wires from compressor relay.
5. Remove nuts from compressor relay.

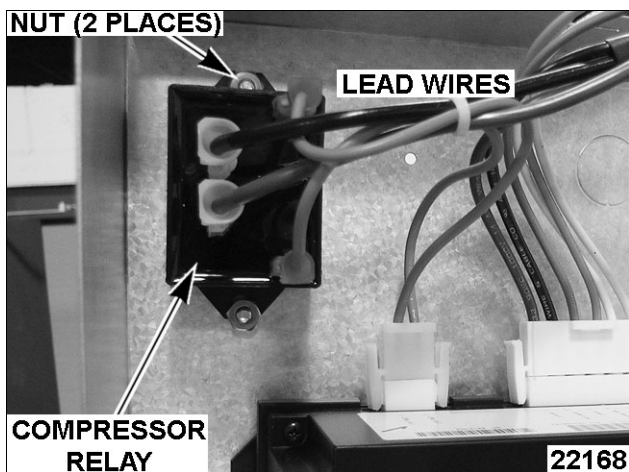

6. Reverse the procedure to install.

CABINET AIR SENSOR



⚠ WARNING Disconnect the electrical power to the machine and follow lockout / tagout procedures. There may be multiple circuits. Be sure all circuits are disconnected.

1. Access cabinet air sensor at top of cabinet.
2. Remove evaporator cover as outlined under COVERS & PANELS.
3. Remove screw securing sensor & mounting clip to evaporator compartment.

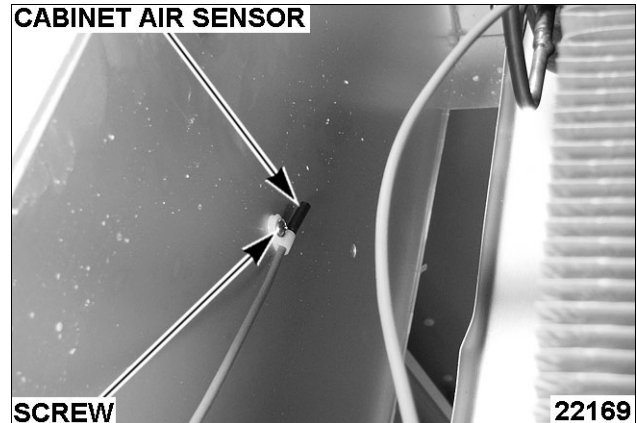

4. Remove harness raceway cover as outlined under COVERS & PANELS.
5. Remove control box cover as outlined under COVERS & PANELS.
6. Route sensor out from evaporator compartment.
7. Disconnect sensor lead wire connector.

NOTE: The green insulation lead wire to green indicator tape on connector for proper connection.

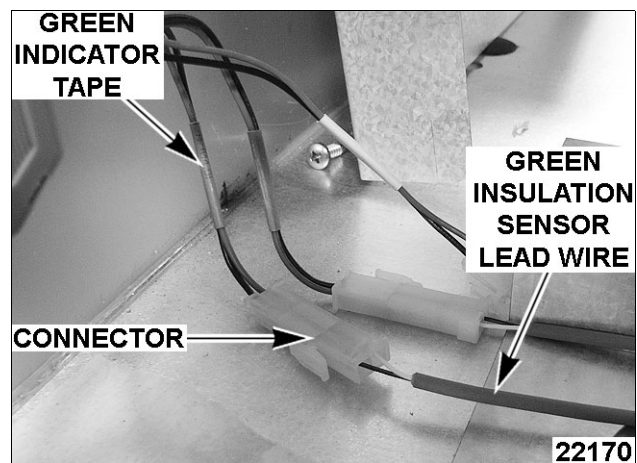

8. Reverse the procedure to install.

EVAPORATOR COIL SENSOR



⚠ WARNING Disconnect the electrical power to the machine and follow lockout / tagout procedures. There may be multiple circuits. Be sure all circuits are disconnected.

1. Access cabinet coil sensor at top of cabinet.
2. Remove evaporator cover as outlined under COVERS & PANELS.
3. Pull sensor out from evaporator fins.

NOTE: Sensor location for replacement.

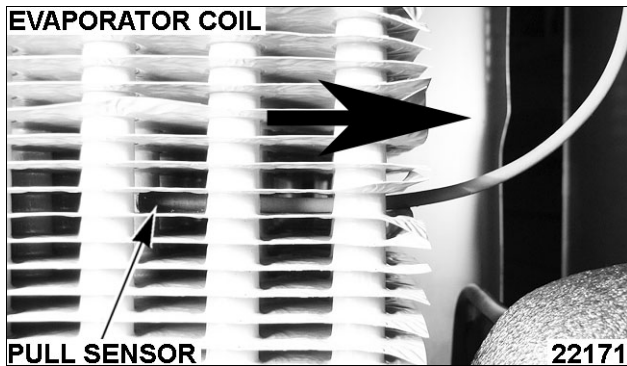

4. Remove harness raceway cover as outlined under COVERS & PANELS.
5. Remove control box cover as outlined under COVERS & PANELS.
6. Route sensor out from evaporator compartment.
7. Disconnect sensor lead wire connector.

NOTE: The blue insulation lead wire to blue indicator tape on connector for proper connection.

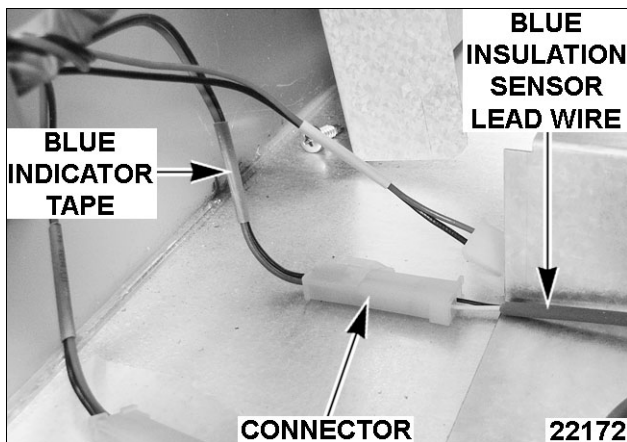

8. Reverse procedure to install.

THERMAL EXPANSION VALVE



⚠ WARNING Disconnect the electrical power to the machine and follow lockout / tagout procedures. There may be multiple circuits. Be sure all circuits are disconnected.

1. Access thermal expansion valve at top of cabinet.
2. Remove evaporator cover as outlined under COVERS & PANELS.
3. Cut wire ties off from refrigerant line insulation.
4. Remove pipe insulation from refrigerant line.
5. Remove insulation from refrigerant line.

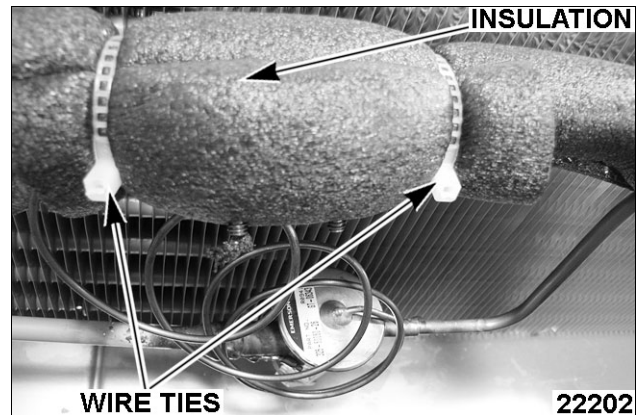

6. Loosen bolts securing sensor from refrigerant line.
7. Pull sensor out from mounting bracket.

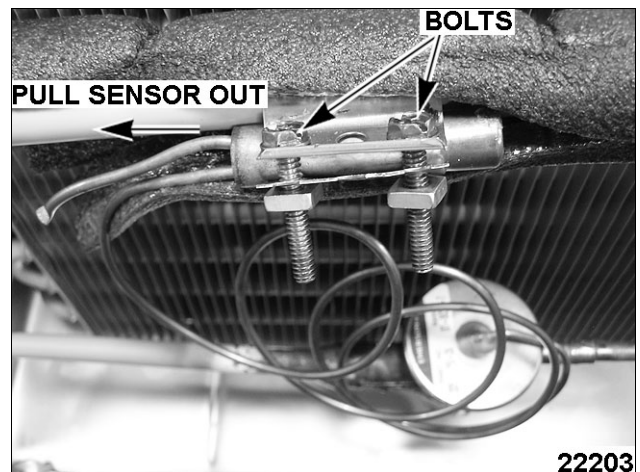

8. Remove expansion valve from the liquid line at inlet and outlet of valve.
9. Install replacement expansion valve into inlet and fasten sensor to suction line.
10. Recharge unit and check for leaks.
11. Put system back into operation and check the superheat as outlined under CHECK REFRIGERANT CHARGE in SERVICE PROCEDURES AND ADJUSTMENTS.

NOTE: Sensor must be insulated.

NOTE: It is recommended that the filter/drier be changed when this part is replaced.

EVAPORATOR COIL / DEFROST HEATER



⚠ WARNING Disconnect the electrical power to the machine and follow lockout / tagout procedures. There may be multiple circuits. Be sure all circuits are disconnected.

1. Access defrost heater at top of cabinet.
2. Remove evaporator cover as outlined under COVERS & PANELS.
3. Remove harness raceway cover as outlined under COVERS & PANELS.
4. Disconnect heater lead wire connector.

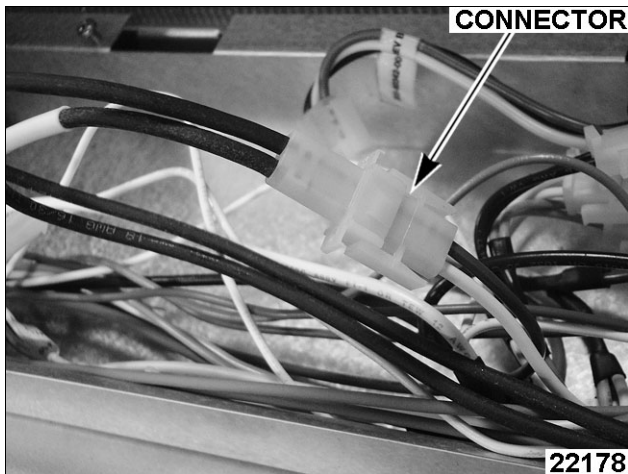

5. Remove adhesive tape over refrigeration lines.

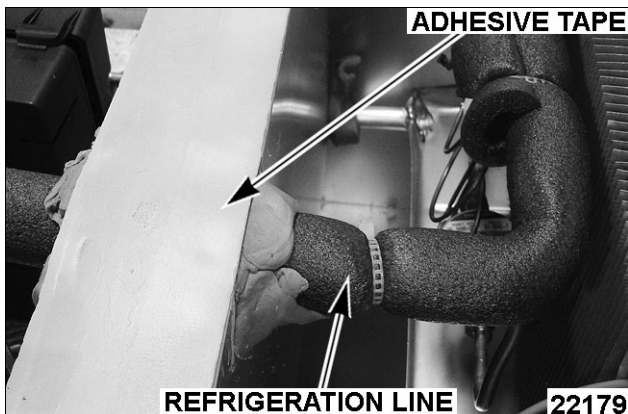

6. Lift evaporator coil up and out from evaporator compartment to expose bottom of evaporator coil.

NOTE: Do Not kink refrigeration lines or damage lead wires.

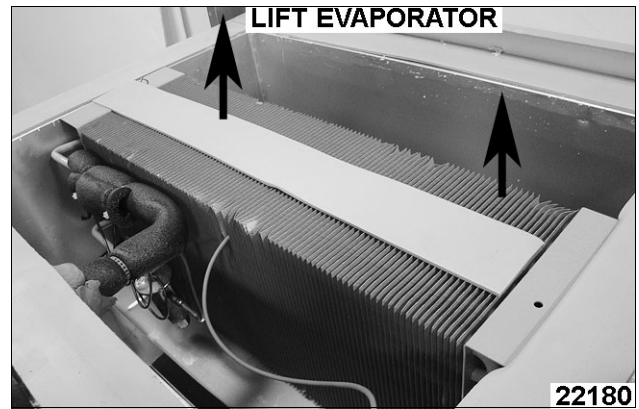

7. Remove defrost heater mounting clips from evaporator coil to release defrost heater.

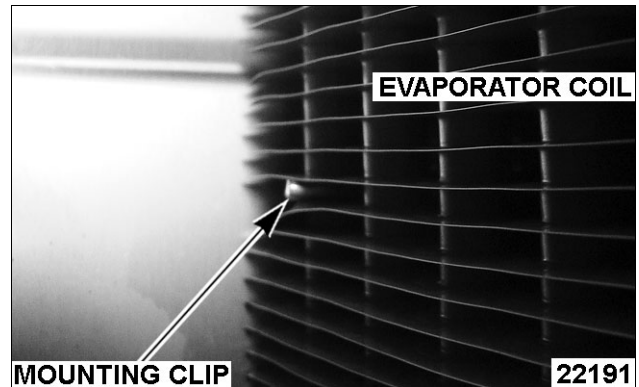

8. Route heater lead wires out from evaporator compartment.
9. Reverse the procedure to install.

DOOR GASKET



⚠ WARNING Disconnect the electrical power to the machine and follow lockout / tagout procedures. There may be multiple circuits. Be sure all circuits are disconnected.

To Remove:

1. Open cabinet door to gain access to door gasket.
2. Start at one corner of the gasket and pull gasket out from the gasket retaining channel.
 - A. Continue to pull gasket from door until gasket is completely out of gasket retaining channel.

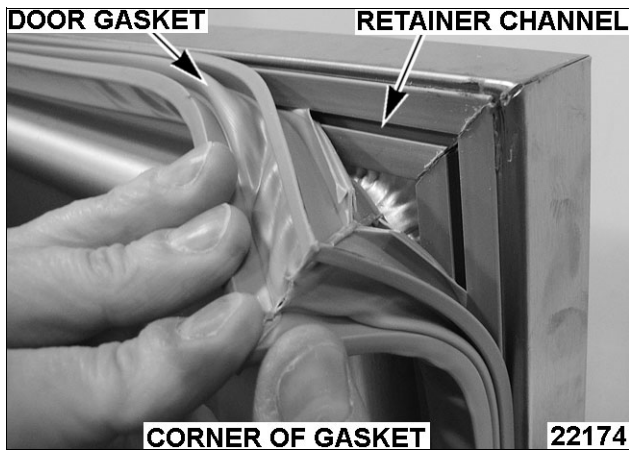

To Install:

1. Run a small bead of food grade silicone in gasket retainer channel.
2. Install gasket starting at corners pressing into retainer gasket channel and work towards center.

DOOR ASSEMBLY



⚠ WARNING Disconnect the electrical power to the machine and follow lockout / tagout procedures. There may be multiple circuits. Be sure all circuits are disconnected.

1. Remove screw from upper door hinge.

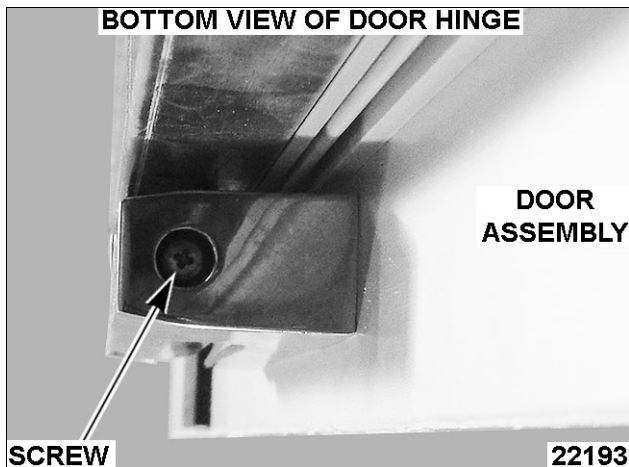

2. Lift door assembly upward off hinges and set door assembly aside.
3. Reverse the procedure to install.

NOTE: Install original hinge assemblies onto replacement door.

EVAPORATOR FAN



⚠ WARNING Disconnect the electrical power to the machine and follow lockout / tagout procedures. There may be multiple circuits. Be sure all circuits are disconnected.

1. Access evaporator fan lead wires at top of cabinet.
2. Remove evaporator cover as outlined under COVERS & PANELS.
3. Disconnect lead wires to evaporator fans.

NOTE: Mark lead wires for later installation.

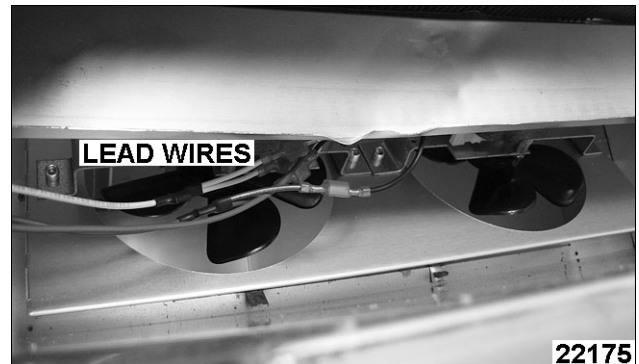

4. Open cabinet door to gain access to evaporator fan housing.
5. Loosen screws securing evaporator air duct to cabinet.
 - A. Slide evaporator air duct away from right side cabinet wall and allow duct to lower into cabinet.

NOTE: Mounting holes in evaporator air duct are keyhole slots.

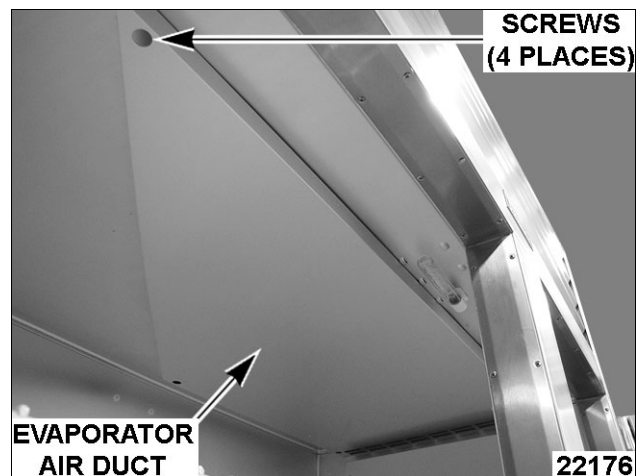

6. Remove screws securing evaporator fan housing to evaporator compartment.

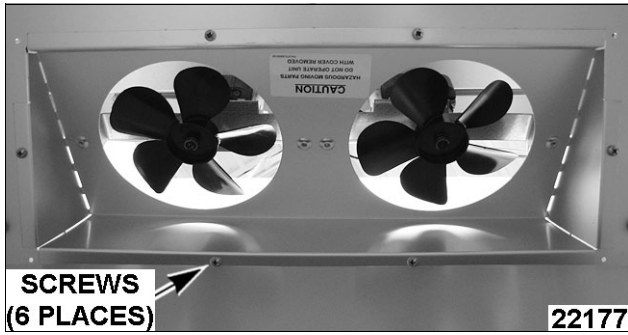

7. Allow evaporator fan housing to lower out of cabinet.
8. Reverse the procedure to install.

CONDENSING UNIT COMPONENTS



⚠ WARNING Disconnect the electrical power to the machine and follow lockout / tagout procedures. There may be multiple circuits. Be sure all circuits are disconnected.

⚠ WARNING This procedure requires the use of refrigerants. Be certain the work area is well ventilated. Safety goggles and gloves shall be worn since refrigerants may cause burns to the skin

Compressor

1. Remove condenser / compressor cover as outlined under COVERS & PANELS.
2. Evacuate refrigeration system.

NOTE: The use of reclaiming equipment is mandatory.

3. Use of screwdriver to lift retaining brace upward off junction box cover.

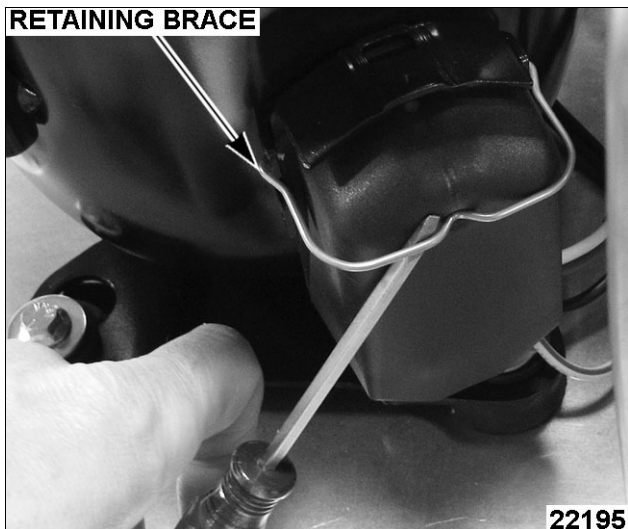

4. Disconnect lead wires from compressor junction

box.

NOTE: Mark wire location for installation.

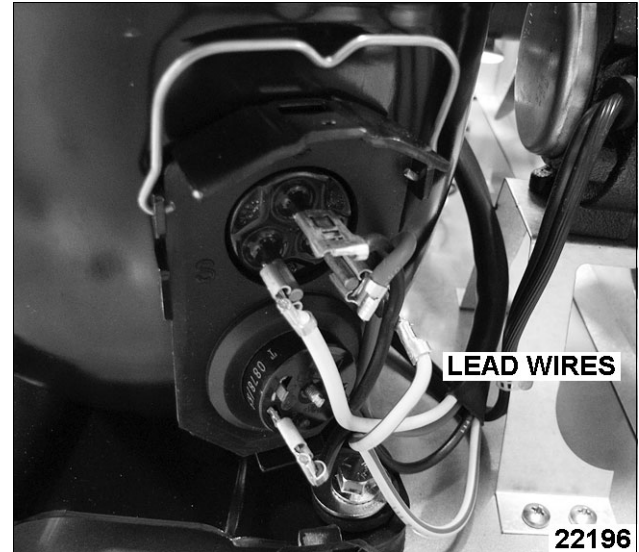

5. Remove insulation from refrigerant line.
6. Disconnect suction and discharge lines from compressor.
7. Remove bolts securing compressor to cabinet.

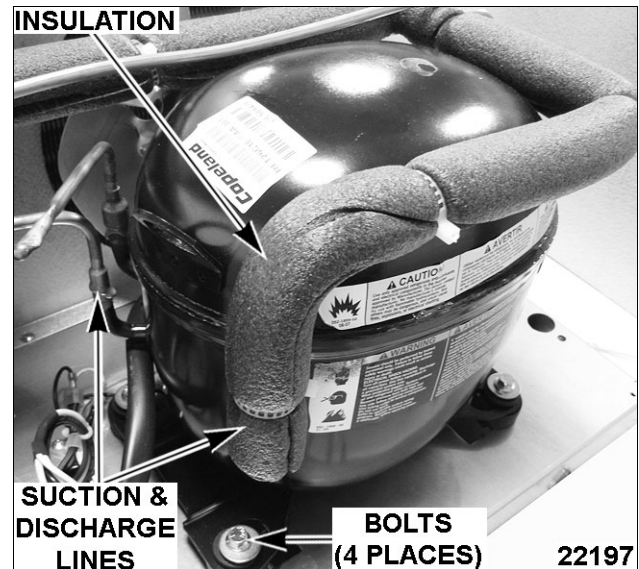

8. Install new compressor and connect wire leads at compressor junction box.
9. Install new filter drier.
10. Evacuate refrigeration system.
11. Charge system and put unit into operation.
12. Check for proper operation.

Condenser Fan Assembly

1. Remove condenser / compressor cover as outlined under COVERS & PANELS.
2. Disconnect lead wires to condenser fan.
3. Remove screws securing condenser fan mounting bracket to cabinet.

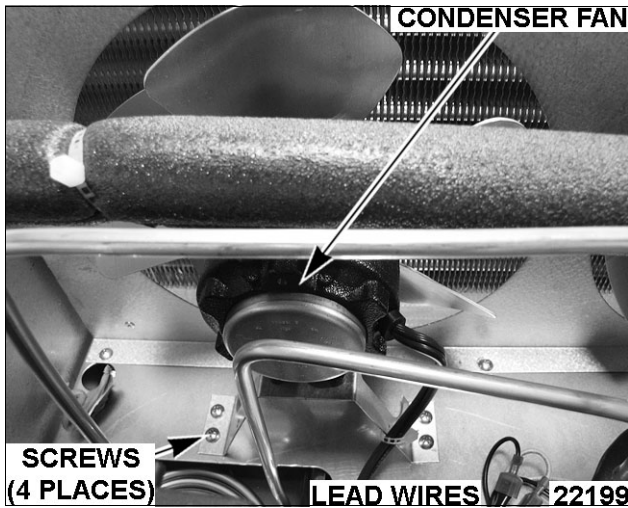

- Remove the screws securing mounting bracket to condenser fan.

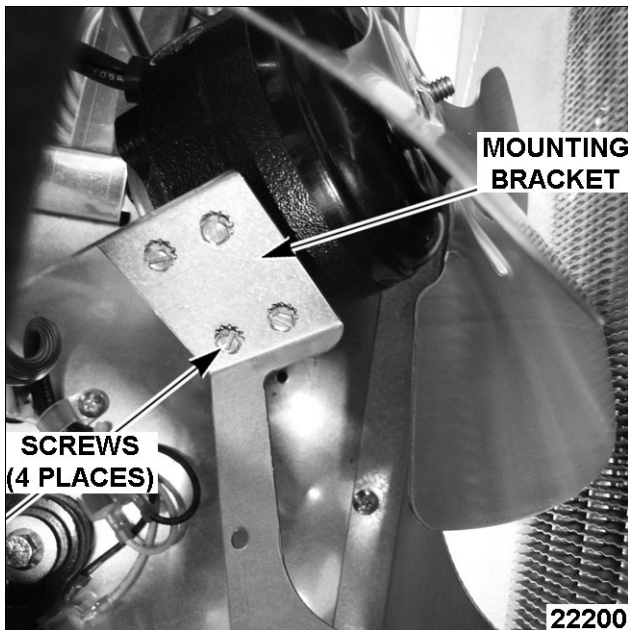

- Reverse the procedure to install.

Condenser Coil

⚠ WARNING This procedure requires the use of refrigerants. Be certain the work area is well ventilated. Safety goggles and gloves shall be worn since refrigerants may cause burns to the skin

- Evacuate refrigeration system.

NOTE: The use of reclaiming equipment is mandatory.

- Remove condenser / compressor cover as outlined under COVERS & PANELS.
- Disconnect inlet and outlet lines at the soldered connections nearest the condenser coil.
- Remove screws securing coil to mounting plate.

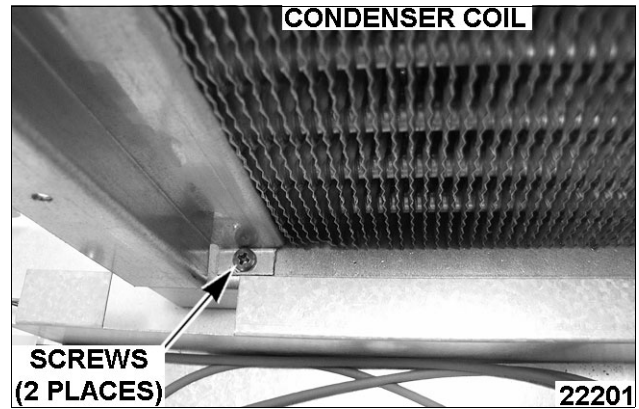

- Reverse procedure to install coil, then proceed to next step.

NOTE: It is recommended that the filter drier be changed when this part is replaced.

- Evacuate refrigeration system.

NOTE: The use of reclaiming equipment is mandatory.

- Charge system and put unit into operation.

Filter Drier

⚠ WARNING This procedure requires the use of refrigerants. Be certain the work area is well ventilated. Safety goggles and gloves shall be worn since refrigerants may cause burns to the skin

⚠ WARNING After pump-down, refrigerant lines will contain pressure.

- Remove condenser / compressor cover as outlined under COVERS & PANELS.
- Remove filter drier from liquid lines.
- Install a new filter drier.
- Evacuate refrigeration system.

NOTE: The use of reclaiming equipment is mandatory.

- Charge system and put unit into operation.

HOT GAS CONDENSATE PAN



⚠ WARNING Disconnect the electrical power to the machine and follow lockout / tagout procedures. There may be multiple circuits. Be sure all circuits are disconnected.

- Remove condenser / compressor cover as outlined under COVERS & PANELS.
- Remove screw securing hot gas coil retaining bracket to the cabinet.

NOTE: Do not damage the coil during removal.

- Lift the retaining bracket up out from insert slot in cabinet.

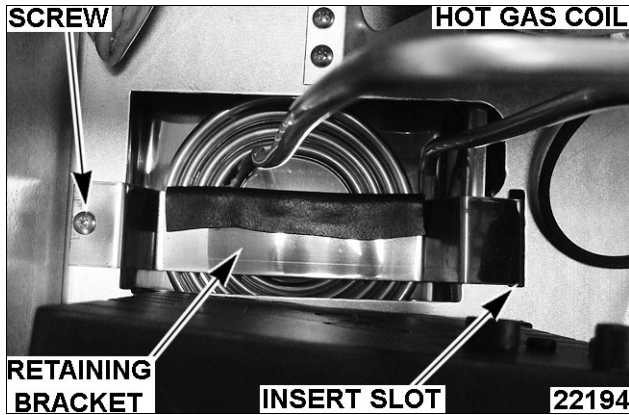

- Lift the hot gas coil out of condensate pan.
- Pull hot gas pan from cabinet.
- Reverse procedure to install.

SERVICE PROCEDURES AND ADJUSTMENTS



WARNING Certain procedures in this section require electrical test or measurements while power is applied to the machine. Exercise extreme caution at all times. If test points are not easily accessible, disconnect power and follow lockout / tagout procedures, attach test equipment and reapply power to test.

CHECK REFRIGERANT CHARGE (SUPERHEAT, SUB COOLING & SPLIT TEMPERATURES)

Introduction

Superheat is the heat that the refrigerant vapor absorbs above the boiling point.

Helpful Hints

- 7 degrees F is a desirable superheat at coil outlet, but superheat for the TXV's are set at the factory.

Procedure

1. Superheat Temperature

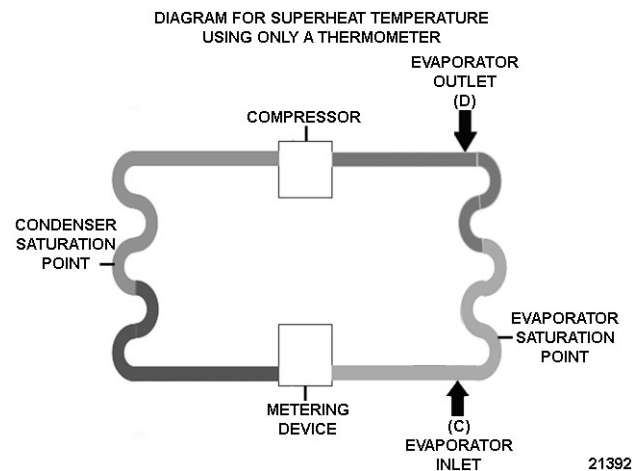

- Connect a temperature probe thermocouple to the evaporator coil outlet (D).
 - Install a piece of pipe insulation around the thermocouple probe.
- Connect a temperature probe thermocouple to the evaporator coil inlet (C).
 - Install a piece of pipe insulation around the thermocouple probe.
- If applicable, install all evaporator box covers over evaporator.

5. Let refrigerant system run. Temperature readings should be taken after the cabinet is at pull down temperature & just before the compressor cycles off.
6. Take readings of evaporator coil inlet (C) & evaporator coil outlet (D) lines.
 - A. Subtract temperature reading of evaporator coil outlet temperature (D) to the evaporator coil inlet temperature (C) reading to obtain a superheat temperature.

Example: evaporator outlet temp. (D) - evaporator inlet temp. (C) = superheat temp.

NOTE: TXV superheat is set at the factory and is not adjustable.

- B. If superheat temperature reading is out of spec, call Refrigeration Service Support.
7. Remove thermocouples and install all covers & panels.

Sub Cooling & Split Temperatures

DIAGRAM FOR SUB COOLING & SPLIT TEMPERATURES USING ONLY A THERMOMETER

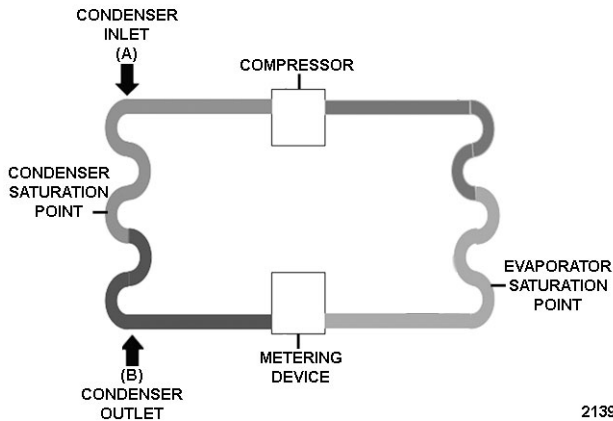

21393

1. Connect a temperature probe thermocouple to the condenser coil inlet (A).
 - A. Install a piece of pipe insulation around the thermocouple probe.
2. Connect a temperature probe thermocouple to the condenser coil outlet (B).
 - A. Install a piece of pipe insulation around the thermocouple probe.
3. If applicable, install all evaporator box covers over evaporator.
4. Let refrigerant system run for approximately 3 to 5 minutes before taking temperature readings.
5. Take readings of condenser coil inlet (A) & condenser coil outlet (B) lines.
 - A. To obtain a sub cooling temperature reading: add condenser coil inlet (A) & condenser coil outlet (B) readings divide by 2 and then subtract condenser coil outlet (B) reading.

Example: [(condenser inlet (A) + condenser outlet temp. (B)) / 2] - condenser outlet (B) = sub cooling temperature.

- B. To obtain a split temperature reading: add condenser coil inlet (A) & condenser coil outlet (B) readings divide by 2 and then subtract ambient temperature reading.

Example: [(condenser inlet (A) + condenser outlet (B)) / 2] - ambient temp. = split temperature.

6. If split temperature reading is out of spec, call Refrigeration Service Support.
7. Remove thermocouples and install all covers & panels.

CHECKING FOR LEAKS



⚠ WARNING Disconnect the electrical power to the machine and follow lockout / tagout procedures. There may be multiple circuits. Be sure all circuits are disconnected.

⚠ WARNING This procedure requires the use of refrigerants. Be certain the work area is well ventilated. Safety goggles and gloves shall be worn since refrigerants may cause burns to the skin

1. Access the refrigeration system.
2. Connect the low (blue) side of gauge manifold to schrader valve.
3. Connect refrigerant bottle to center of gauge manifold and open valve on bottle.
4. Open valve on low side of gauge manifold and charge system with a small amount of refrigerant (1 to 2 ounces).
5. Close bottle valve and gauge valve.
6. Disconnect refrigerant bottle and connect nitrogen bottle.
7. Set output valve on nitrogen bottle to 120 psi.
8. Open nitrogen bottle valve and gauge manifold valve (low side) and allow pressure to equalize.
9. Shut off both valves and disconnect the nitrogen bottle.
10. Using a leak detector or a thick soapy solution, check for leaks at all tubing connections.
 - A. If any leaks are detected, repair the leak and recheck.
 - B. If no leaks are discovered, evacuate system as outlined under EVACUATING SYSTEM.
11. Charge system as outlined under CHARGING SYSTEM.

EVACUATING SYSTEM

Introduction

Refrigeration reclaiming equipment is required.

The goal in system evacuation is to remove all the non-condensables as possible. No evacuation method will remove 100% of the moisture and air from within the refrigeration circuit. Because of this, guidelines and methods must be developed and adhered to ensuring only harmless amounts of contaminants remain in the system.

Guidelines

⚠ WARNING Do not pressurize system above 150 PSIG prior to evacuation or during leak test procedures.

- Use only a two stage vacuum pump (2 CFM or greater) and electronic micron gauge integrated into a refrigeration reclaiming system.
- Evacuate from high to low sides of system.
- No chemical additives or alcohols are to be used to Dry Up a system.
- No Flushing with solvents or any type of Freon alien to system. Blow down of system with DRY NITROGEN prior to evacuation is acceptable and many times desirable. See SYSTEM CLEAN UP.
- Evacuate to 500 microns of mercury.

Procedure



⚠ WARNING Disconnect the electrical power to the machine and follow lockout / tagout procedures. There may be multiple circuits. Be sure all circuits are disconnected.

⚠ WARNING This procedure requires the use of refrigerants. Be certain the work area is well ventilated. Safety goggles and gloves shall be worn since refrigerants may cause burns to the skin

1. Access the refrigeration system.
2. Connect low (blue) side of gauge manifold to schrader valve on compressor access line and high (red) side of gauge manifold to schrader valve on filter drier line.
3. Connect center line of gauge manifold to vacuum pump.
4. Turn vacuum pump on and open both sides of gauge manifold.
5. Pull a vacuum to 500 microns.
6. Break the vacuum with 3 psig of operating refrigerant. On remote systems DRY NITROGEN may be preferred.

7. Repeat steps 5 and 6 once.
8. Pull vacuum to 500 microns.
9. Charge system and check for proper operation.

CHARGING SYSTEM



⚠ WARNING Disconnect the electrical power to the machine and follow lockout / tagout procedures. There may be multiple circuits. Be sure all circuits are disconnected.

⚠ WARNING This procedure requires the use of refrigerants. Be certain the work area is well ventilated. Safety goggles and gloves shall be worn since refrigerants may cause burns to the skin

1. Access the refrigeration system.
2. Be sure system is properly leak checked and evacuated before charging as outlined under LEAK CHECK and EVACUATING SYSTEM.
3. Connect high side of gauge manifold to the receiver valve. Make certain both valves are closed on the gauge manifold.

NOTE: Charge the system through the high side to prevent liquid refrigerant from reaching the compressor.

4. Connect refrigerant bottle to center connection of gauge manifold.
5. Turn the refrigerant bottle upside down.
6. Open valves on bottle, gauge manifold and receiver.
7. Allow the proper amount of refrigerant to enter the system, then shut the gauge and bottle valves.
8. Disconnect the hose from the receiver valve.
9. Reconnect power to the unit and check for proper operation and high pressure leaks.
10. Disconnect power to the unit and replace any covers removed.
11. Reconnect power to the unit.

SYSTEM CLEAN UP



⚠ WARNING Disconnect the electrical power to the machine and follow lockout / tagout procedures. There may be multiple circuits. Be sure all circuits are disconnected.

Introduction

When a compressor burn-out is encountered, the service person must make the determination as to the degree of system contamination.

Normally a compressor burn-out will fit in one of three categories:

- Contained - compressor oil not acidic, no oil discoloration.
- Contaminated compressor - oil acidic, discoloration of oil, contamination limited to compressor.
- Massive contamination - contaminated oil and / or refrigerant pumped into system.

Contained

1. Replacement of liquid line drier.
2. Install suction line filter drier.
3. Replacement of compressor.
4. Evacuation (to 500 microns).
5. Charge by weight.

Contaminated Compressor

The Contaminated Compressor requires the same procedure as the Contained Burn-Out. Plus, the system must be flushed after the compressor and drier have been removed.

Massive Contamination

The replacement compressor **MUST NOT** be installed until after system clean-up procedures have been completed.

1. Remove the burned-out compressor as outlined under COMPRESSOR in REMOVAL AND REPLACEMENT OF PARTS.
2. Remove any of the in-line refrigerant controls.
3. Flush high and low sides of system until acidic oil has been removed from the remaining components of the system.
4. Reassemble refrigeration system.
5. Evacuate refrigeration system as outlined under EVACUATING SYSTEM.
6. Charge system as outlined under CHARGING SYSTEM.
7. Reconnect power and check for proper operation.
8. Disconnect power and install any panels removed.
9. Reconnect power. After 24 hours of operation check system for acid and proper operation.
10. Once the system is determined clean, remove the suction line drier.

SOFTWARE VERSION

The control program software version can be determined by:

1. Turn power on to the Intela-Traul control.
2. While control powers up the control display will show the software version for a second (C32 and above).

CONTROL CALIBRATION

NOTICE Certain components in this system are subject to damage by electrostatic discharge during field repairs. A field service grounding kit is available to prevent damage. The field service grounding kit must be used anytime the control board is handled.

1. Verify that the cabinet air sensor is functioning properly as outlined under CABINET AIR, & CABINET COIL, SENSOR TEST.
2. Place a thermocouple of a temperature tester in the center of right incoming air slot of the cabinet.
 - A. Route thermocouple through hinge side of door to the outside of the cabinet and close the door(s).
3. Set the control temperature to 0°F.
4. Allow the cabinet temperature to stabilize (minimum 3 cycles).
5. Note temperature reading on temperature tester and control display at the exact time the refrigeration system turns off.
6. If the temperature difference between the two readings is greater than $\pm 2^{\circ}\text{F}$ or $\pm 1^{\circ}\text{C}$, adjust if:
 - A. If temperature test shows a temperature higher than control, increase.
 - B. If temperature test shows a temperature lower than control, decrease.
 - C. If temperature difference is greater than the range of the control, replace controller (range $\pm 50^{\circ}\text{F}$. or $\pm 10^{\circ}\text{C}$.).
7. Check for proper operation.
8. Remove temperature tester thermocouple from the cabinet.

CONTROL PARAMETERS

NOTE: Not all control parameters can be adjusted at the customer level of access. To adjust parameters not at the customer level it will be necessary to access the engineering level.

NOTE: If 30 seconds elapse between keypad presses, the controller will revert to a cabinet temperature display (normal operation). If the wrong security code is entered, the controller will revert to a cabinet temperature display (normal operation). To save settings & exit customer access mode, press the alarm cancel keypad or not pressing any keypads for 30 seconds.

To Access Customer Level

1. Use security code 0A1 by:
2. Pressing the Set keypad until CUS is displayed.
3. Press the Set keypad until left zero is flashing with three zeros displayed.
4. Press the Set keypad until center zero is flashing with three zeros displayed.
5. Press the Down Arrow until A is shown in center display.
6. Press Set keypad until right zero is flashing with 0A0 displayed.
7. Press the Up Arrow until 1 is flashing in right display.
8. Press the Set keypad. Display should read SP (Thermostat Set Point) indicating controller is in Customer Access Mode.

To Access Engineering Level

1. Press the Set keypad until CUS is displayed.
2. Press the DOWN ARROW keypad until ENG is displayed.
3. Press the Set keypad until 000 is displayed with the left digit flashing.
4. Press the DOWN ARROW keypad until left digit displays 9.
5. Press the Set keypad until the center digit flashes.
6. Press the DOWN ARROW keypad until center digit displays 9.
7. Press the Set keypad until the right digit flashes.
8. Press the DOWN ARROW keypad until the right digit displays E.
9. Press SET keypad then the DOWN ARROW keypad until FOC is displayed.

NOTE: Hex File GF1 (Standard) and GF3 (-10 °F Freezer).

10. Use the DOWN ARROW keypad to scroll through control parameters.

PARAMETER DISPLAYED	DESCRIPTION / ACCESS LEVEL	RANGE	DEFAULT PARAMETER SETTINGS (FREEZER MODEL SERIES)	
			Standard Freezer Model G1, G2, & G3 Hex File GF1	-10 °F Freezer Model G1 & G2 Hex File GF3
SPH software ver. C28	Temperature set point high / Cus. level	SHH to SHL	0 °F	-5.0°F
SPL software ver. C28	Temperature set point low / Cuc. level	SLH to SLL	-4.0°F	-10.0°F
SP software ver. C32 & above	Set point cut out temperature		-3.0 °F	-10.0 °F
SPD software ver. C32 & above	Set point differential	SP TO SPD	2.0 °F	4.0 °F
SHL software ver. C28	Set point high-low / Eng. level	-40°F. up to current setting for SHH	-2.0 °F	-8.0 °F
SHH software ver. C28	Set point high-high / Eng. level	From current setting for SHL up to 266°F.	2.0 °F	-5.0 °F

G SERIES FREEZER - SERVICE PROCEDURES AND ADJUSTMENTS

PARAMETER DISPLAYED	DESCRIPTION / ACCESS LEVEL	RANGE	DEFAULT PARAMETER SETTINGS (FREEZER MODEL SERIES)	
			Standard Freezer Model G1, G2, & G3 Hex File GF1	-10 °F Freezer Model G1 & G2 Hex File GF3
SLL software ver. C28	Set point low-low/ Eng. level	-40°F. up to current setting for SLH	-6.0 °F	-13.0 °F
SLH software ver. C28	Set point low-high/ Eng. level	from current setting for SLL up to 266 °F	-2.5 °F	-10 °F
RO	Room ambient offset / Cuc. level	±3°F. in 1/2°F. increments	0 °F	0 °F
HI	Upper temperature limit / Eng. level	-40 °F. to 266°F.	10.0°F	5.0 °F
LO	Lower temperature limit / Eng. level	-40 °F. to 266°F.	-15.0 °F	-15.0 °F
SCL	Temperature scale °F or °C / Cuc. level	°F. or °C.	°F	°F
AC	Anti-cycling- minute / Eng. level	1-10 min. in 1 min. increments	3	3
DEF	Defrost type- ele., gas, none, off cycle / Eng. level	ELE, GAS, NONE or OFF	ELE	ELE
IBD	Intervals between defrosts- hours / Eng. level	1-9 hrs. in 1 hr. increments	4.0	4.0
DDC	Maximum defrost duration- minute / Eng. level	0-30 min. in 5 min. increments	30	30
CDE	Coil temperature at end of defrost cycle / Eng. level	40 °F. to 80 °F. in 5 °F. increments	45 °F	45 °F
DDE	Drip time at end of defrost cycle- minute / Eng. level	1-5 min. in 1 min. increments	4	4
BDD	Blower delay at drip time-minute / Eng. level	0-5 min. in 1 min. increments	6	7
BSD	BSD after defrost end / Eng. level	30 °F. to 40 °F. in 1 °F. increments	20.0 °F	10.0 °F
ODD	Display hold after defrost-minute / Eng. level	0-30 min. in 5 min. increments	10	10
SD	Start-Stop defrost / Cuc. level	YES / NO	Start a new defrost cycle at any time or stops a current defrost cycle.	
CL	Set the clock time / Cuc. level	00:00 to 23:59 Setting for 12hr. or 24 hr. time (H=hours, N=min., S=sec.)	Set the clock for standard time or military time.	

G SERIES FREEZER - SERVICE PROCEDURES AND ADJUSTMENTS

PARAMETER DISPLAYED	DESCRIPTION / ACCESS LEVEL	RANGE	DEFAULT PARAMETER SETTINGS (FREEZER MODEL SERIES)	
			Standard Freezer Model G1, G2, & G3 Hex File GF1	-10 °F Freezer Model G1 & G2 Hex File GF3
DAY	Set the clock date / Cus. level	(Y=year, N=month, E=day # in week example: Sun=1 Sat=7)	Set the year, month, day of the month and day of the week.	
DS	Daylight Savings / Cus. level	ON / OFF	ON	ON
DL1	Defrost lockout 1 / Cus. level	2:00 to 8:00 in. 30 min. increments & OFF	OFF	OFF
DL3	Defrost lockout 3 / Cus. level	14:00 to 20:00 in. 30 min. increments & OFF	OFF	OFF
DL4	Defrost lockout 4 / Cus. level	2:00 to 20:00 in. 30 min. increments & OFF	OFF	OFF
DCF software ver. C28	Dewpoint correction factor / Cus. level	0 to 100	100	100
CON	Compressor default On time / Eng. level	5-30 min. in 1 min. increments	20	20
COF	Compressor Off time / Eng. level	5-30 min. in 1 min. increments	5	5
EL	Evaporator coil temperature / Cus. level	n/a	Displays evaporator coil temperature in real time every time an arrow keypad is pressed.	
CB	Cabinet air temperature / Cus. level	n/a	Displays cabinet air temperature in real time every time an arrow keypad is pressed.	
PLn software ver. C28	Display line voltage / Eng. level	n/a	Displays power line voltage in real time every time an arrow keypad is pressed.	
RCO	Cycle compressor relay / Eng. level	n/a	Turns On/Off the compressor relay for 10 seconds or until an arrow keypad is pressed.	
RdF	Cycle defrost relay / Eng. level	n/a	Turns On/Off the defrost relay for 10 seconds or until an arrow keypad is pressed.	
RFA	Cycle fan relay / Eng. level	n/a	Turns On/Off the blower relay for 10 seconds or until an arrow keypad is pressed.	
RDH	Cycle door heater relay / Eng. level	n/a	Turns On/Off the door heater for 10 seconds or until an arrow keypad is pressed.	
CEP	Clear EPROM & load defaults / Eng. level	n/a	Clear all control memories and reloads the factory default parameters.	
Ref	Software version, revision, step / n/a level	n/a	Firmware revision in the format X9.9 (X=version, 9=major revision, .9= minor revision).	
Sn	Cabinet serial number / Cus. level	n/a	n/a	

11. To exit, press the alarm cancel keypad or not pressing any keypads for 30 seconds.

EVAPORATOR COIL SENSOR TEST

1. Access the customer level by pressing the Set keypad until CUS is displayed.
2. Press the Set keypad until left zero is flashing with three zeros displayed.
3. Press the Set keypad until center zero is flashing with three zeros displayed.
4. Press the Down Arrow until A is shown in center display.
5. Press Set keypad until right zero is flashing with 0A0 displayed.
6. Press the Up Arrow until 1 is flashing in right display.
7. Press Up Arrow until EL is displayed then press Set keypad.
 - A. If display shows -40 check for loose wire connections and retest.
 - B. If display shows 266 OR higher replace the evaporator coil sensor.

NOTE: Erratic display readings indicate an open or short in the control.

CABINET AIR SENSOR TEST

1. Access the customer level by pressing the Set keypad until CUS is displayed.
2. Press the Set keypad until left zero is flashing with three zeros displayed.
3. Press the Set keypad until center zero is flashing with three zeros displayed.
4. Press the Down Arrow until A is shown in center display.
5. Press Set keypad until right zero is flashing with 0A0 displayed.
6. Press the Up Arrow until 1 is flashing in right display.
7. Press Up Arrow until AA is displayed then press Set keypad.
 - A. If display shows 111 check for loose wire connections and retest.
 - B. If display shows 32.0 correct inadequate air flow through the condenser, replace the cabinet air sensor, or condenser fan assembly.

NOTE: Erratic display readings indicate an open or short in the control.

CABINET AIR, CABINET COIL, & SENSOR RESISTANCE TEST

1. Gain access to the sensor.
2. Disconnect sensor lead wires from connector.
3. Set the multi meter to ohm scale and connect leads to sensor lead wires.

4. Verify multi meter reading to the temperature conversion chart as follows.

Temperature °F	Ohm Reading K Ohms	Temperature °C
-5.0	99.9	-20.5
0	85.2	-17.7
5.0	72.9	-15.0
10.0	62.4	-12.2
15.0	53.7	-9.4
20.0	46.2	-6.7
25.0	39.9	-3.9
30.0	34.6	-1.1
32.0	32.7	0.0
35.0	30.1	1.7
40.0	26.1	4.4
45.0	22.8	7.2
50.0	19.9	10.0
55.0	17.4	12.8
60.0	15.3	15.6
65.0	13.5	18.3
70.0	11.9	21.1

5. If multi meter reading indicates an open or is outside the ohm range $\pm 10\%$, replace the sensor.

COMPRESSOR RELAY TEST

1. Turn supply power Off.
2. Gain access to the compressor relay.
3. Disconnect N.O. & COM lead wires from relay.
4. Set the multi meter to ohm scale and connect leads to relay N.O. & COM terminals .
5. Verify the multi meter reading indicates an open circuit. If not, replaced the relay .

DOOR SWITCH TEST

1. Turn supply power Off.
2. Open the cabinet doors.
3. Gain access to the door switch.
4. Disconnect lead wires from switch.
5. Set the multi meter to ohm scale and connect leads to switch terminals .
6. Verify the multi meter reading indicates an open circuit. If not, replaced the switch.

ELECTRICAL OPERATION

COMPONENT FUNCTION

Intela-Traul Control	Performs the following functions: A. Displays all data for the current software revision & mode of operation. B. Cycles refrigeration system to maintain cabinet temperatures. C. Cycles defrost relay to defrost evaporator coil. D. Monitors power losses as well as component malfunctions. E. Monitors door position.
Compressor	Pumps refrigerant through refrigeration system lines and components.
Start Capacitor	Wired in series with the start windings to help start compressor motor.
Run Capacitor	Continually in circuit to help compressor motor during operation.
Compressor Relay	Senses current of run winding of compressor motor. Normally open contacts close when the run winding draws a high amperage at start and brings the start capacitor and start windings into the circuit. As the motor reaches operating speed (less amperage through run winding), the normally open contacts open and removes the start capacitor and start windings from the circuit.
Evaporator Fan	Draws air from the cabinet and moves the air through the evaporator coil back into cabinet.
Condenser Fan	Draws air across condenser coil to aid in removing heat from the refrigerant and move air across compressor to aid in cooling the compressor.
Defrost Heater	Defrosts evaporator coil and prevents water droplets from evaporator coil to freeze before they can drain to the condensate pan. Operates only during defrost cycle.
Cabinet Air Sensor	Monitors air temperature inside cabinet.
Cabinet Coil Sensor	Monitors the evaporator coil while the cabinet is powered.
.	
Door Switch	Monitors door for open or closed position. Evaporator fans stop when door is open.
Solenoid Valve	Normally closed when energized, allows refrigerant to flow from receiver to evaporator coil.
Door Perimeter Heater	Prevents condensate from forming on door frame.
Intela-Traul Relay Module . . .	Controls power to the following components: A. Evaporator fan(s). B. Door heater. C. Defrost heater. D. Compressor relay. E. Solenoid valve.
Main Switch	Controls power to intela-traul relay box, compressor relay, door switch, & auxiliary components. Removes power from listed components.
Heated Glass Doors	Auxiliary component, prevents condensate from forming on glass door.
Condensate Evaporator	Auxiliary component, when energized dissipates condensate in the evaporator pan.

SEQUENCE OF OPERATION

Refrigeration System

1. The control must be powered on.
2. The control monitors cabinet air temperature and senses a need for cooling.
3. The compressor motor is energized and refrigerant is pumped through the system.
4. The TXV monitors the evaporator superheat and meters the amount of refrigerant entering the evaporator.
5. The control senses the cabinet air temperature requirements have been met.
6. Compressor motor de-energized by the compressor relay.
7. System is cycled by control.

Freezer Mode

1. Main switch closed.
 - A. Relay module energized.
 - B. Control energized.
 - C. Compressor relay.
 - D. Condenser fan(s) energized.
 - E. Compressor motor energized.
2. Control displays software revision & then cabinet temperature.
3. After 2-1/2 minutes evaporator fan(s) energized.
4. The refrigeration system will cycle on the air temperature of the cabinet.
 - A. On at the high set point (SP + D) temperature.
 - B. Off at the low set point (SP) temperature.

NOTE: Set points are selected in the parameter menu.

NOTE: If the cabinet door is opened during operation, the evaporator fan(s) will shut Off.

5. Evaporator fan(s) cycled on time and or temperature.
6. Unit is cycled by control.

Defrost Mode

1. The defrost mode can be entered manually or run automatically.
2. When control initiates a defrost cycle, the control snowflake is illuminated.
 - A. Defrost heater energized.
 - B. Compressor motor de-energized.
 - C. Evaporator fan(s) de-energized.
3. Defrost cycle operates until the EL temperature setting is reached or the maximum DDC time setting has elapsed.
4. Defrost mode cycled by control.

COMPONENT LOCATION

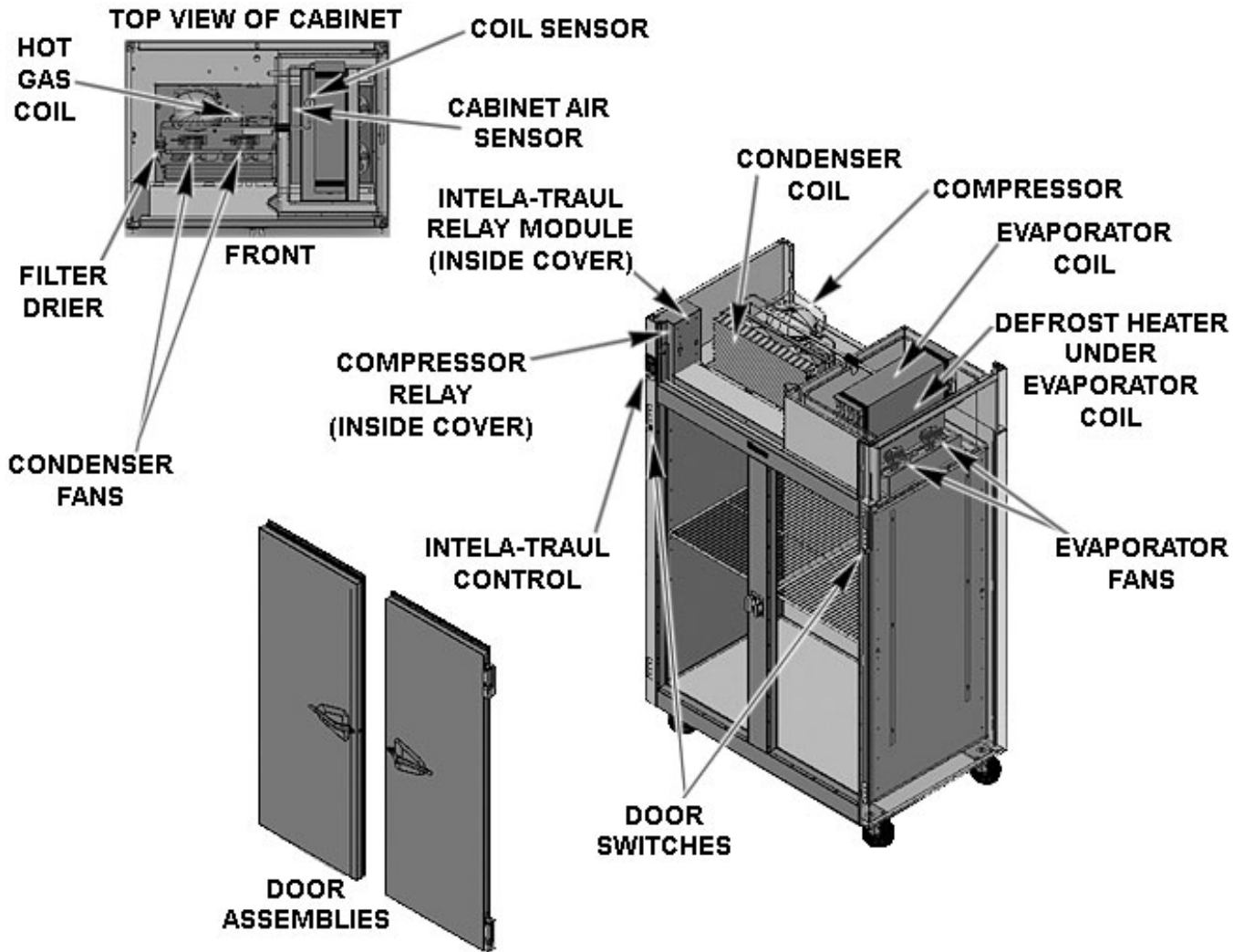

22198

WIRING DIAGRAMS

115V/60HZ/1PH

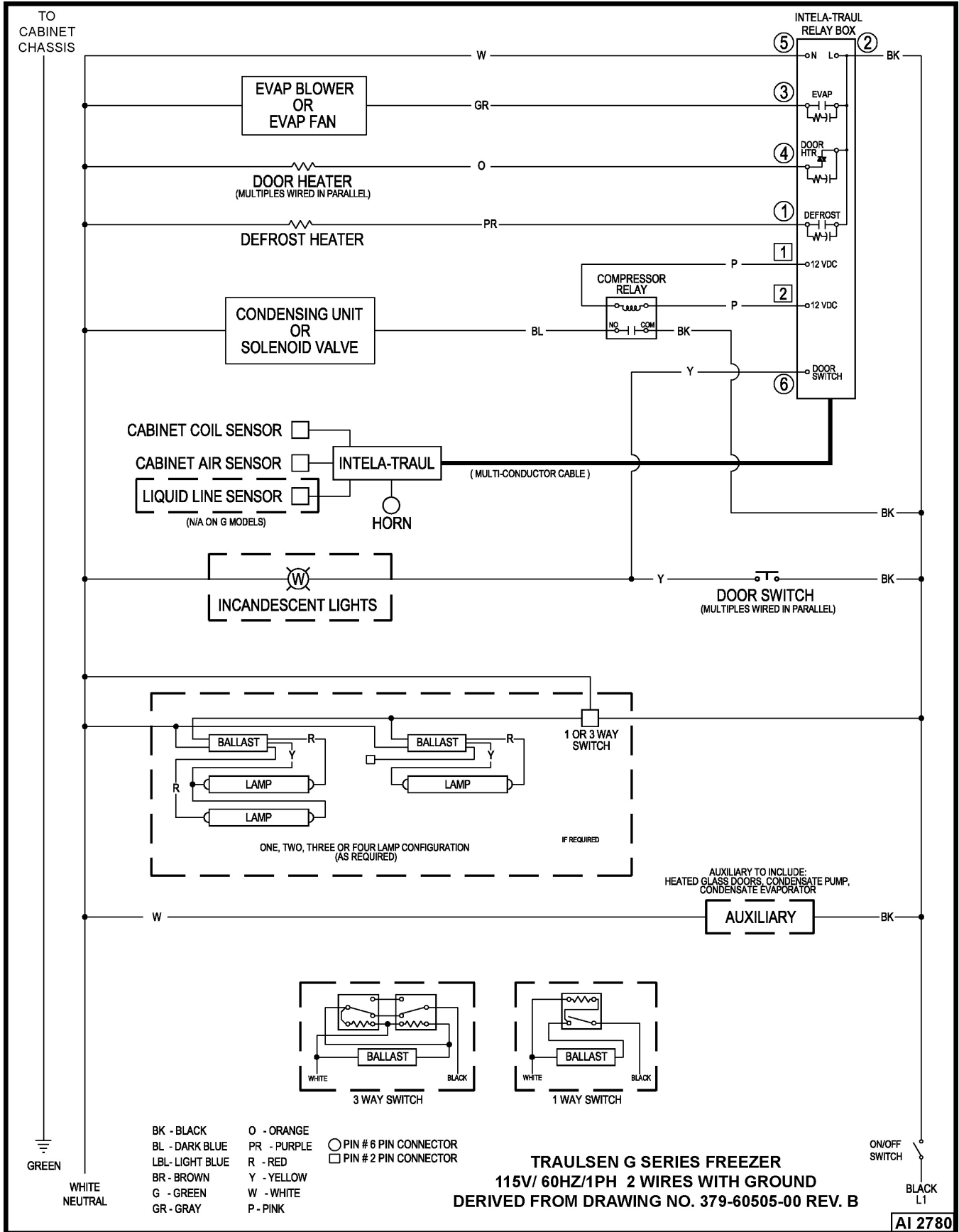

G SERIES FREEZER - ELECTRICAL OPERATION

220V/50-60HZ/1PH

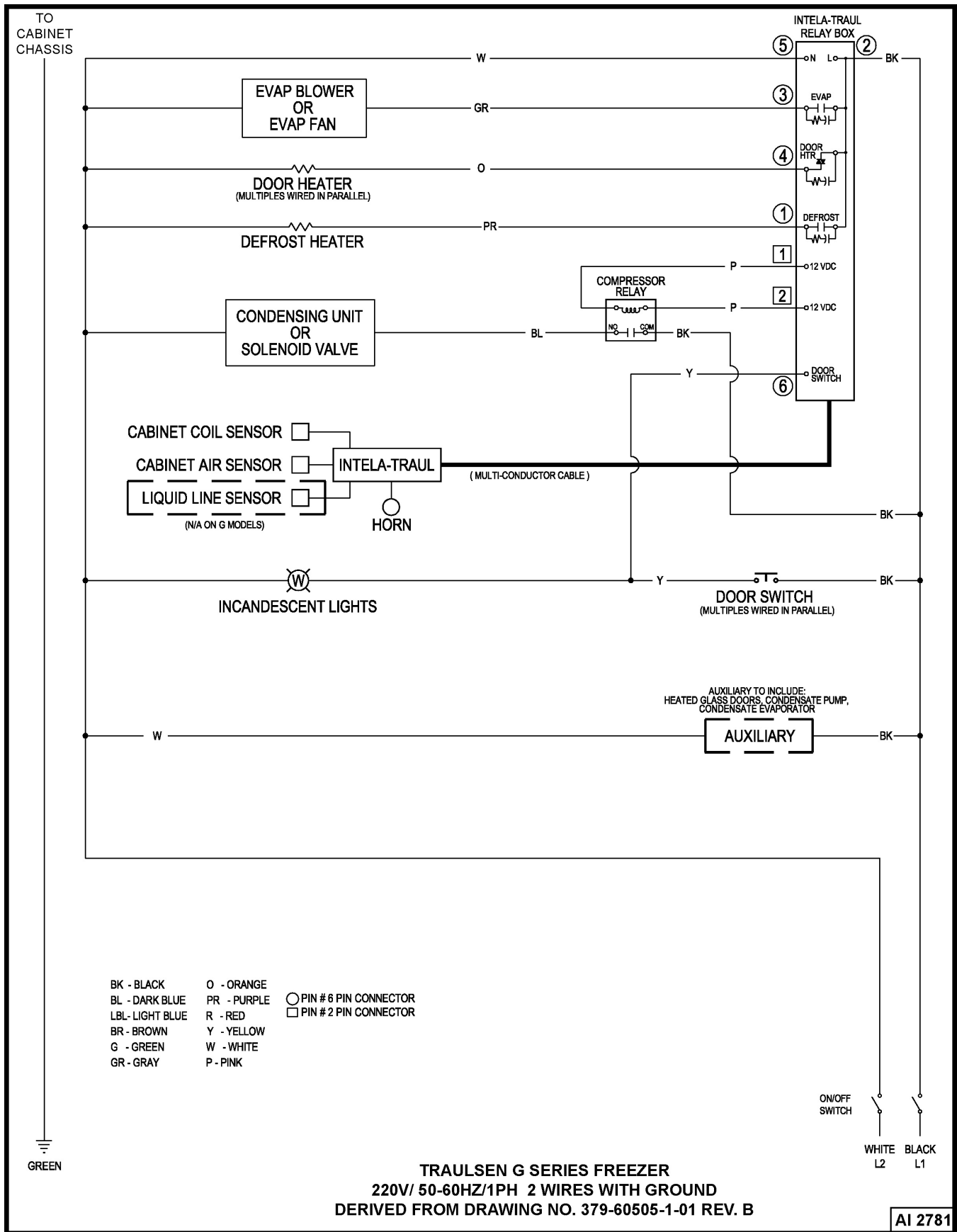

- | | | |
|-----------------|-------------|-------------------------|
| BK - BLACK | O - ORANGE | ○ PIN # 6 PIN CONNECTOR |
| BL - DARK BLUE | PR - PURPLE | □ PIN # 2 PIN CONNECTOR |
| LBL- LIGHT BLUE | R - RED | |
| BR - BROWN | Y - YELLOW | |
| G - GREEN | W - WHITE | |
| GR - GRAY | P - PINK | |

TROUBLESHOOTING

SYMPTOM	POSSIBLE CAUSES
Nothing runs, blank control.	<ol style="list-style-type: none"> 1. Main circuit breaker open. 2. Main on/off switch off. 3. Power cord unplugged.
Compressor will not run, no current draw.	<ol style="list-style-type: none"> 1. Cabinet temperature satisfied. 2. Door open or malfunction door switch, with display on control. 3. Incorrect wiring. 4. Cabinet air sensor malfunctioned. 5. Start component malfunctioned. 6. Compressor motor windings open. 7. Control malfunctioned. 8. Compressor relay malfunctioned. 9. Relay module malfunctioned.
Compressor will not run, current draw and trips breaker.	<ol style="list-style-type: none"> 1. Start component malfunctioned. 2. Compressor motor windings shorted. 3. Locked rotor.
Defrost time too long.	<ol style="list-style-type: none"> 1. Evaporator coil sensor malfunctioned. 2. Incorrect wiring. 3. Control malfunctioned. 4. Defrost heater malfunctioned.
Compressor short cycles.	<ol style="list-style-type: none"> 1. Improper air flow over evaporator coil. 2. Expansion valve malfunctioned. 3. Low ambient conditions. 4. Evaporator fan(s) malfunctioned. 5. Cabinet air sensor malfunctioned. 6. Evaporator coil sensor malfunctioned. 7. Control malfunctioned.
Compressor run time lengthy.	<ol style="list-style-type: none"> 1. Partial loss of refrigerant. 2. High ambient conditions. 3. Improper air flow over condenser coil. 4. Excessive product load. 5. Excessive door openings. 6. Door gasket(s) need replaced. 7. Condenser fan(s) malfunctioned. 8. Cabinet air sensor malfunctioned. 9. Cabinet coil sensor malfunctioned. 10. Contaminates in refrigeration system. 11. Control malfunctioned. 12. Relay module malfunctioned.
Continuous compressor operation.	<ol style="list-style-type: none"> 1. Loss of refrigerant. 2. Excessive door openings. 3. Cabinet air sensor malfunction. 4. Control malfunctioned.
Low suction pressure.	<ol style="list-style-type: none"> 1. Restriction in refrigeration system. 2. Loss of refrigerant. 3. Expansion valve blocked.
High head pressure.	<ol style="list-style-type: none"> 1. Improper air flow across condenser. 2. Extreme ambient conditions. 3. Overcharge of refrigerant. 4. Air in refrigerant system. 5. Condenser fan(s) malfunctioned.

G SERIES FREEZER - TROUBLESHOOTING

SYMPTOM	POSSIBLE CAUSES
Iced Evaporator coil.	<ol style="list-style-type: none"> 1. Evaporator fan(s) malfunctioned. 2. Verify defrost control parameter settings. 3. Evaporator coil sensor malfunctioned. 4. Compressor relay malfunctioned. 5. Control relay module. 6. Cabinet air sensor malfunctioned. 7. Control malfunctioned. 8. Refrigerant system malfunctioned.
Will not defrost.	<ol style="list-style-type: none"> 1. Defrost heater(s) malfunction. 2. Incorrect wiring. 3. Compressor relay malfunctioned. 4. Evaporator coil sensor malfunctioned. 5. Control malfunctioned.
Control display blank.	<ol style="list-style-type: none"> 1. Main power supply. 2. Relay module malfunctioned. 3. On/off switch malfunctioned. 4. Control malfunctioned.

-NOTES-

-NOTES-

-NOTES-