



Quality Refrigeration

# OWNER'S MANUAL

Instructions for the installation, operation

and maintenance of all Traulsen:

R & A Series Reach-In & Roll-In Refrigerators\*

R & A Series Pass-Thru & Roll-Thru Refrigerators\*

R & A Series Reach-In & Roll-In Freezers\*

R & A Series Reach-In Refrigerator/Freezers\*

R & A Series Reach-In & Roll-In Hot Food Cabinets\*

R & A Series Pass-Thru & Roll-Thru Hot Food Cabinets\*

\* **Please Note:** This manual is intended for use with the above referenced equipment manufactured after January 01, 2013. To obtain a copy of the correct Owner's Manual to support the same products manufactured prior to this date, please contact Traulsen Service at (800) 825-8220.

This Traulsen unit is built to our highest quality standards. We build our refrigerators, freezers and heated cabinets this way as a matter of pride. This philosophy has made Traulsen the leader in commercial refrigeration since 1938. We thank you for your choice and confidence in Traulsen equipment and we know you will receive many years of utility from this equipment.

All Traulsen units are placed on a permanent record file with the service department. In the event of any future questions you may have, please refer to the model and serial number found on the name tag affixed to the unit. Should you need service, however, call us on our toll free number, 800-825-8220 between 7:30 am and 4:30 pm CST, Monday-Friday. It is our pleasure to help and assist you in every possible way.

## INSTALLER

COMPLETE THE FOLLOWING INFORMATION PRIOR TO UNIT INSTALLATION

INITIAL START DATE: \_\_\_\_\_ SERIAL NO. \_\_\_\_\_

MODEL TYPE: \_\_\_\_\_

COMPANY/INDIVIDUAL NAME: \_\_\_\_\_



INSTALLER: \_\_\_\_\_

# TABLE OF CONTENTS

<b>I. THE SERIAL TAG</b>	Page 1	<b>VII. INTELA-TRAUL®</b>	
<b>II. RECEIPT INSPECTION</b>	Page 2	a-Control Features	Page 8
<b>III. INSTALLATION</b>		b-Alarm Explanations	Page 9
a-Location	Page 2	c-Control Panel	Page 10
b-Packaging	Page 2	d-Notes To The User	Page 10
c-Installing Legs or Casters	Page 2	e-Enter The Customer Access Code	Page 10
d-Shelf Pins	Page 3	f-Customer Service Parameters	Page 11
e-Roll-In Model Installation	Page 3	g-Adjusting Thermostat Set Point	Page 11
f-Attaching Double Depth Units Together	Page 3	h-Adjusting Thermostat Set Point Low	Page 12
g-Installing The Condensate Evaporator	Page 3	i-Changing The Temperature Scale	Page 12
h-Remote Installation	Page 4	j-Setting The 24-Hour Clock	Page 13
i-Cord & Plug	Page 4	k-Setting The Date	Page 14
j-Power Supply	Page 4	l-Setting Daylight Savings Time	Page 14
k-Wiring Diagram	Page 4	m-Starting A Manual Defrost	Page 15
l-Clearance	Page 4	n-Setting Defrost Lockouts	Page 16
<b>IV. OPERATION</b>		o-Adjusting The Room Temperature Offset	Page 17
a-Refrigerators	Page 5	p-Setting The Audible Alarm Style	Page 17
b-Freezers	Page 5	q-Viewing Sensor Temperatures	Page 18
c-Hot Food Cabinets	Page 5	r-Door Open Icon	Page 18
<b>V. CARE &amp; MAINTENANCE</b>		s-Hot Food Units - Adjusting The Thermostat	Page 18
a-Cleaning The Condenser	Page 5	t-Hot Food Units - Turning The Unit OFF & ON	Page 19
b-Hinge Replacement	Page 6	u-Hot Food Units - Temperature Adjustment	Page 19
c-Replacing The Gaskets	Page 6	<b>VIII. TROUBLE SHOOTING GUIDE</b>	Page 20
d-Cleaning The Exterior	Page 6	<b>XI. SPARE PARTS LIST</b>	Page 21
e-Cleaning The Interior	Page 6	<b>XII. STAINLESS STEEL OVERVIEW</b>	Page 22
f-Adjusting The Shelves	Page 6	<b>XIII. CARE OF STAINLESS STEEL</b>	Page 23
g-Replacing The Light Bulb	Page 7	<b>XIV. CORROSION REMEDIES</b>	Page 23
<b>VI. OTHER</b>		<b>XV. WARRANTY INFORMATION</b>	Page 24
a-Service Information	Page 7		
b-Spare Parts	Page 7		
c-Warranty Registration	Page 7		

## I. THE SERIAL TAG

The serial tag is a permanently affixed sticker on which is recorded vital electrical and refrigeration data about your Traulsen product, as well as the model and serial number. This tag is located in the upper right interior compartment on all reach-in/pass-thru and roll-in/roll-thru refrigerator, freezer and dual-temp models. For hot food models, this tag is located on the top of the unit behind the louvers to protect it from the heat.

		4401 Blue Mound Rd. Ft. Worth, TX 76106 800-825-8220	
MODEL: MODELO: MODELE:			<small>SCAN FOR SERVICE INFO</small>
S/N:			
<b>REFRIGERANT / REFRIGERANTE / RÉFRIGÉRANT</b>			
SYS1 (REFM):			
Hi Press. (PRESH):			
Lo Press. (PRESL):			
SYS2 (REFA):			
Hi Press. (PRESH):			
Lo Press. (PRESL):			
<b>Input Power (ELIN) - FOR INDOOR USE ONLY</b>			
(Symbol 1) <small>(Primary Safety)</small>	(Symbol 2) <small>(Primary Sanitation)</small>	(Symbol 3) <small>(Primary Energy)</small>	(Symbol 4) <small>(NHEE)</small>
(Symbol 5) <small>(Alt Safety / Other)</small>	(Symbol 6) <small>(Alt Sanitation / Other)</small>	(Symbol 7) <small>(Alt Energy / Other)</small>	(Symbol 8) <small>(Cust QR Code / Other)</small>
Device/Part Number: Part.PartNum		Device/Part Notes: Part.Character04	
<b>COMPONENTS / COMPOSANTS / COMPONENTES</b>			
COMP AMPS:		LIGHT WATTS:	
COND FAN AMPS:		CTRL AMPS:	
SYS/DEF HTR AMPS:		R/TMCE HTR AMPS:	
DOOR HTR AMPS:		MIN CIRCUIT IN AMPS:	
SYS/EVAP FAN AMPS:		MAX OVR CURRENT PROTECTION AMPS:	
<small>870-60297-00 REV.B 11/21/14</small>			

## II. RECEIPT INSPECTION

All Traulsen products are factory tested for performance and are free from defects when shipped. The utmost care has been taken in crating this product to protect against damage in transit. All interior fittings have been carefully secured and the legs or casters are boxed and strapped inside to prevent damage. Door keys will be attached to the handle with a nylon strip. The handle is protected by an easily removable nylon netting.

You should carefully inspect your Traulsen unit for damage during delivery. If damage is detected, you should save all the crating materials and make note on the carrier's Bill Of Lading describing this. A freight claim should be filed immediately. If damage is subsequently noted during or immediately after installation, contact the respective carrier and file a freight claim within 10 days. Under no condition may a damaged unit be returned to Traulsen. without first obtaining written permission (return authorization).

## III. INSTALLATION

### III. a - LOCATION:

Select a proper location for your Traulsen unit, away from extreme heat or cold. Allow enough clearance between the unit and the side wall in order to make use of the door stay open feature at 120° (self-closing feature operates up to 90°). The door(s) must be able to open a minimum of 90° in order to make use of the maximum clear door width available.

### III. b - PACKAGING:

All Traulsen units are shipped from the factory bolted to a sturdy wooden pallet and packaged in a durable cardboard container. The carton is attached to the wooden skid with the use of large staples. These should first be removed to avoid scratching the unit when lifting off the crate.

Most exterior stainless steel surfaces have a protective vinyl covering to prevent scratching during manufacturing, shipping and installation. After the unit is installed in place of service, remove and discard the covering from all surfaces.

To remove the wooden pallet, first if at all possible, we suggest that the cabinet remain bolted to the pallet during all transportation to the point of final installation. The bolts can then be removed with a 3/4" socket wrench. Avoid laying the unit on its front, side or back for removal of the pallet.

**NOTE: DO NOT LAY THE UNIT ON ITS SIDE DURING TRANSPORTATION OR INSTALLATION.**

Roll-Thru models also include special interior wood bracing, intended to protect the cabinet during shipment. This bracing should under no circumstances be removed prior to the unit being installed in its final location.

**WARNING:** Read and review these instructions, in their entirety, BEFORE attempting to disassemble and remove the interior bracing.

## III. INSTALLATION (continued)

### III. b - PACKAGING (cont'd):

If either of the diagonal or upper ceiling braces are dropped, they could cause personal injury or damage to the equipment.

To disassemble the bracing, first open the doors and carefully remove the banding that holds the two diagonal braces together.

**WARNING:** The diagonal braces will now be loose and can fall out of position and possibly permit the ceiling corner brace to fall.

Carefully remove one diagonal brace while supporting the ceiling corner brace, so that it does not fall (see figure 1). Next, remove the ceiling brace, the remaining diagonal brace, and lastly the floor brace - then discard. Repeat as necessary for each section of the unit.

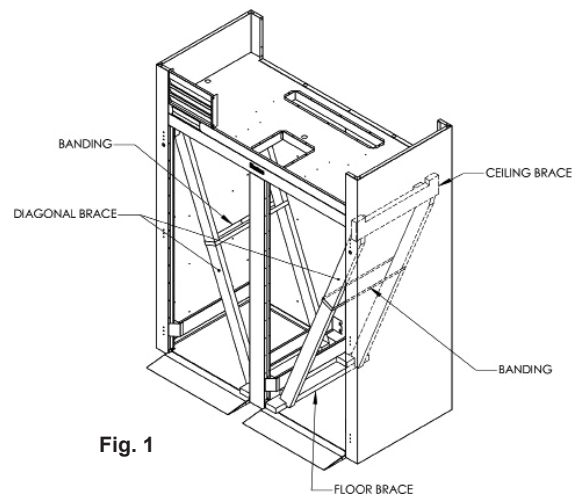

Fig. 1

### III. c - INSTALLING LEGS OR CASTERS:

6" high stainless steel legs are supplied standard for all Traulsen reach-in and pass-thru units. Casters in lieu of legs are available as an optional accessory for the same models. These are shipped from the factory packed inside a cardboard box which is strapped to one of the shelves. Remove the nylon strap and open the box, it should contain either four (4) legs or four (4) casters and sixteen (16) bolts.

**WARNING: THE CABINET MUST BE BLOCKED AND STABLE BEFORE INSTALLING LEGS OR CASTERS.**

To install the legs or casters, first raise and block the reach-in a minimum of 7" from the floor. For installing legs, thread the legs into the threaded holes on the bottom of the cabinet (see figure 2). Be certain that all legs are tightly secured (legs and casters should be tightened to 300 inch/pounds, max). When the unit is set in its final position, it is important for proper operation that the unit be level. The legs are adjustable for this purpose, turn the bottom of the leg counter-clockwise to raise it, clockwise to lower it. Level the unit from front to back as well as side to side in this manner, using a level placed in the bottom of the cabinet.

### III. INSTALLATION (continued)

#### III. c - INSTALLING LEGS OR CASTERS (cont'd):

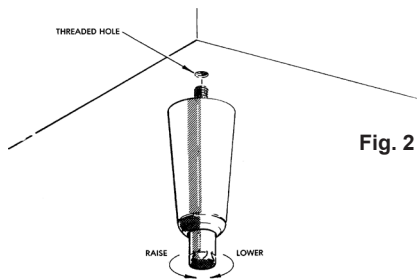

Fig. 2

Please note that Traulsen units are not designed to be moved while on legs. If the unit requires moving, a pallet jack or forklift should be used to prevent damage. For installing casters, the casters are "plate" type, and require the use of four (4) bolts each to secure them firmly to the cabinet bottom at each corner (see figure 3). The caster bolts are tightened using a 1/2" socket wrench.

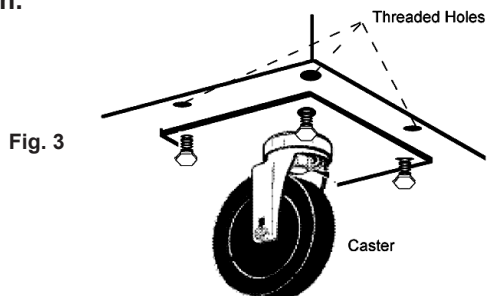

Fig. 3

#### III. d - SHELF PINS:

The unit is supplied with shelves and shelf pins installed. Check all shelf pins to assure they are tightened down as they may have come loose during shipping. Rotate the pins clockwise until they are secured against the side of the cabinet.

#### III. e - ROLL-IN MODEL INSTALLATION:

Roll-In cabinets set on the floor require the floor area to be flat and level. In addition, after the cabinet is set in place, sealant should be used around the perimeter of the base to comply with National Sanitation Foundation requirements (see figure 4). After sealing the unit, the enclosed ramp should then be installed.

##### SEALING BASE OF ROLL-IN MODELS

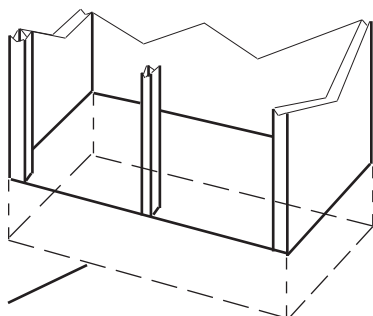

A SEALANT MUST BE USED AROUND THE PERIMETER OF THE BASE OF CABINET AS SHOWN TO FULLY COMPLY WITH SANITARY REQUIREMENTS.

A RECOMMENDED SEALANT IS DOW CORNING SILASTIC RTV

Fig. 4

#### III. e - ROLL-IN MODEL INSTALLATION (cont'd):

A stainless steel threshold ramp(s) is included to facilitate roll in racks. It is shipped wrapped in brown paper and secured to the rack guides inside the cabinet. To secure it in place, remove the two thumb screws in the breaker strip near the bottom door opening. Next, loosen the thumb screws located along the floor at the threshold. Place the ramp(s) on top of the loosened thumb screws and secure tabs on each end to breaker strips with thumb screws previously removed. After installing the ramp(s), it too should be sealed to the floor.

Bumper strips are secured to the back of Roll-In models with thumb screws. Loosen these and make them finger tight to conform with the requirements of the National Sanitation Foundation (NSF).

#### III. f - ATTACHING DOUBLE DEPTH UNITS TOGETHER:

Double depth roll-in/roll-thru units are shipped as two separate components which must be attached together at the jobsite. To accomplish this, first, place the front and rear cabinets in close proximity to each other being careful to align the drain from the front of the rear unit to the drain of the front unit. It will be necessary to level both units together at this time.

Next, using two pipe clamps, pull the units together (see figure 5). Install the covers over the gap formed between the units. From inside the cabinets, using the screws provided, install the breaker strips using the strip as a template.

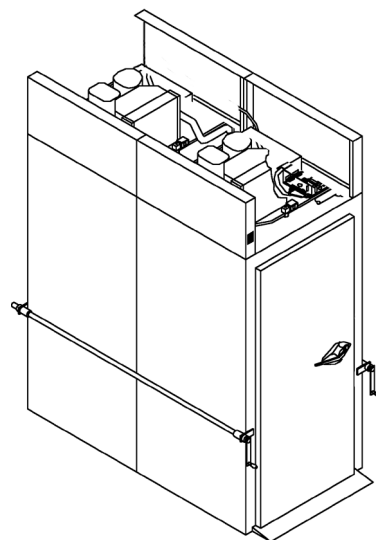

Fig. 5 - Using two pipe clamps, pull the two units together and using the screws provided. Align the breaker strips as a template for the screw pattern inside and outside the cabinet.

#### III. g - INSTALLING THE CONDENSATE EVAPORATOR:

A condensate evaporator is normally supplied on all self-contained models (remote models require provision of either a floor drain or an optional condensate evaporator). On those models supplied with a top-mounted evaporator coil compartment, the condensate evaporator is also secured to the top of the cabinet. Check that the condensate pan is properly located underneath the drain tube.

### III. INSTALLATION (continued)

#### III. g - INSTALLING THE CONDENSATE EVAP (cont'd):

**NOTE:** Some models, such as single section dual-temperature refrigerator/freezers, are supplied with a bottom-mounted condensate evaporator. This is shipped in a cardboard carton secured to the cabinet interior, and must be **PROPERLY** installed prior to use (see instructions supplied with the condensate evaporator).

1) After the cabinet has been uncrated and the legs/casters attached, you must install the bottom-mounted condensate evaporator. 2) Locate the four (4) holes on the exterior bottom towards the rear of the cabinet. 3) Using the provided 10-32 screws, attach the mounting rails to the bottom, (the folded flange is to be turned up and be towards the drain line. 4) Slide condensate pan into the mounting rails. 5) Screw the "U-Trap" on to the drain line located on the rear of the cabinet. 6) Screw the drain extension into the "U-Trap."

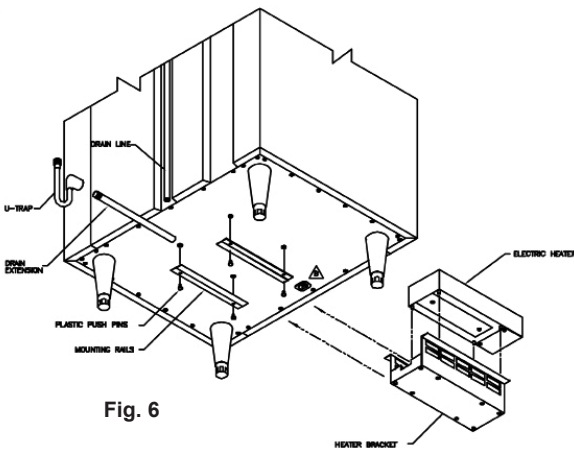

Fig. 6

**NOTE:** The use of the "U-TRAP" supplied is required. Failure to use this component may allow cold air to migrate down the drain line, resulting in condensation on the rear of the cabinet.

A remote model is normally supplied configured for condensate to be run to a floor drain unless purchased with a condensate evaporator. The installer is responsible for making the required extension to the floor drain in accordance with good practice and local regulations.

#### III. h - REMOTE INSTALLATION:

Remote models are supplied without compressors, solenoid valves, etc. The correct voltage, amp listing and refrigerant are listed on the units serial tag. It is the responsibility of the installer to specify and supply the correct size compressor(s) based upon this information and on-site requirements.

#### III. h - REMOTE INSTALLATION (cont'd):

Refrigerant line installation must be done in accordance with good practice and local regulations. See section "III. g" for information concerning condensate removal for remote models.

#### III. i - CORD & PLUG:

Most self-contained models are supplied with a cord & plug attached. It is shipped coiled at the top of the cabinet, secured by a nylon strip. For your safety and protection, all units supplied with a cord and plug include a special three-prong grounding plug on the service cord. Select only a dedicated electrical outlet with grounding plug for power source. **NOTE:** Do not under any circumstances, cut or remove the round grounding prong from the plug, or use an extension cord.

#### III. j - POWER SUPPLY:

The supply voltage should be checked prior to connection to be certain that proper voltage for the cabinet wiring is available (refer to the serial tag to determine correct unit voltage). Make connections in accordance with local electrical codes. Use qualified electricians.

Use of a separate, dedicated circuit is required. Size wiring to handle indicated load and provide necessary overcurrent protector in circuit (see amperage requirements on the unit's serial tag).

#### III. k - WIRING DIAGRAM:

Refer to the wiring diagram for any service work performed on the unit. Should you require one, please contact Traulsen Service at (800) 825-8220, and provide the model and serial number of the unit involved.

#### III. l - CLEARANCE:

In order to assure optimum performance, the condensing unit of your Traulsen unit **MUST** have an adequate supply of air for cooling purposes. Therefore, the operating location must either have a minimum of 12" clearance overhead of the condensing unit or allow for unrestricted air flow at the back of the unit. Clearance of at least 12" above is required in order to perform certain maintenance tasks.



## IV. OPERATION

### IV. a - REFRIGERATORS:

Both refrigerators and freezers do not require manual defrosting. During normal operation, a refrigerator continuously circulates above freezing cabinet air through the coil. A compressor "OFF" cycle occurs every hour to melt any frost which may accumulate on the coil during the compressor "ON" cycle. The control will read "dEF" when this occurs and the evaporator fans will continue to operate. With standard holding refrigerators, high relative humidity is also maintained to prevent dehydration of stored product.

### IV. b - FREEZERS:

During normal operation, a freezer continuously circulates below freezing cabinet air through the coil. The coil requires a periodic defrosting for proper operation. This is accomplished by an automatic, time activated, temperature/time terminated, defrost program. The controller is preset at the factory for six equally spaced defrost cycles within each 24-hour period.

At the start of a freezer defrost cycle, both the compressor and evaporator fans are OFF. The INTELA-TRAUL® control will read "dEF" (see figure 7). The electric heater (attached to the coil) is energized. When a temperature device affixed to the coil senses 70°F (models with electric defrost), the coil is fully defrosted and the compressor operation is resumed, defrost heaters are automatically turned off. The coil fans are delayed from starting at the termination of a defrost cycle. Fan operation is automatically resumed, or they can also be started by a time or temp delay (whichever comes first). In case of temp delay, it uses the same coil sensor and starts at 32°F. The total refrigeration system operation is then resumed.

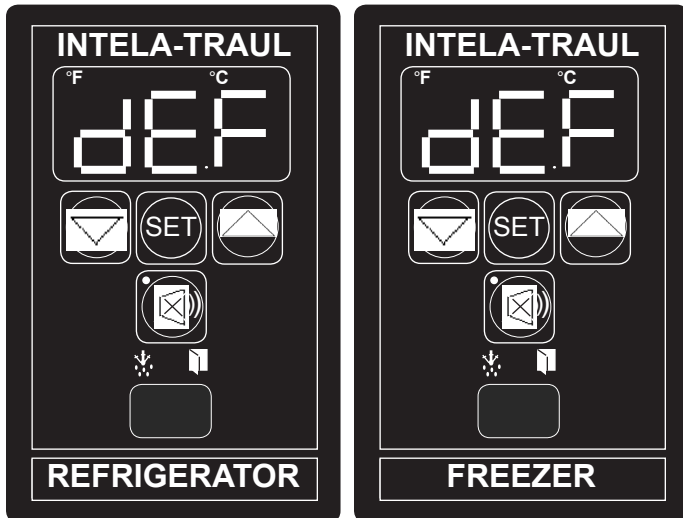

Fig. 7

During freezer defrost operation, heat is confined to the coil enclosure to prevent any significant rise in temperature within the food zone. The fan delay controls function upon termination of a defrost cycle is two-fold. First, to prevent blowing warm air into the food storage area. Second, to prevent any condensation on the defrost coil from being blown into the food storage area.

The INTELA-TRAUL® control is set from the factory to terminate defrost at 20 minutes in the event of a sensor failure. This setting should never be tampered with, without first consulting the factory.

### IV. c- HOT FOOD CABINETS:

Hot food cabinet operation is governed by the INTELA-TRAUL control, which controls the ON/OFF operation of the strip heaters. The control can be set to maintain any operational temperature between 140 - 180° F (in 5°F increments).

Hot food cabinets are delivered from the factory with the control set to the "OFF" position. Follow the instructions in section "VII. t" to get started.

**NOTE:** A vent is included at the top of all hot food cabinets. The vent opening is factory set and secured for best position. Be certain to make sure this vent is kept free of any obstruction.

## V. CARE & MAINTENANCE

### WARNING

**DISCONNECT ELECTRICAL POWER SUPPLY BEFORE CLEANING ANY PARTS OF THE UNIT**

### V. a - CLEANING THE CONDENSER:

The most important thing you can do to insure a long, reliable service life for your Traulsen is to regularly clean the condenser coil.

The condensing unit requires regularly scheduled cleaning to keep the finned condenser clean of lint and dust accumulation. The INTELA-TRAUL control will notify you through a "CLN-FIL" message when cleaning is necessary (see page 8). Keeping the condenser clean allows the cabinet to operate more efficiently and use less energy.

To clean the condenser, first disconnect electrical power to the cabinet and lift up the front louver assembly. To lift this, remove the two screws located on both sides at the bottom of the louver assembly (see figure 8).

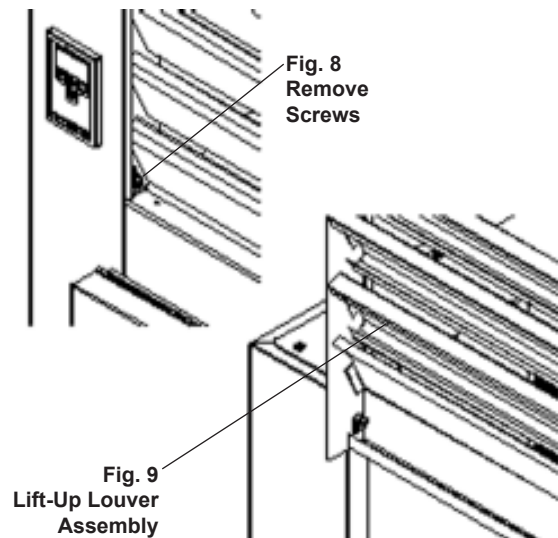

Fig. 9  
Lift-Up Louver  
Assembly

## V. CARE & MAINTENANCE (cont'd)

### V. a - CLEANING THE CONDENSER:

Once the screws are removed, the panel can be pivoted upwards allowing full access to the front facing condenser (see figure 9).

Vacuum or brush any dirt, lint or dust from the finned condenser coil, the compressor and other cooling system parts (see figure 10). If significant dirt is clogging the condenser fins, use compressed air to blow this clear.

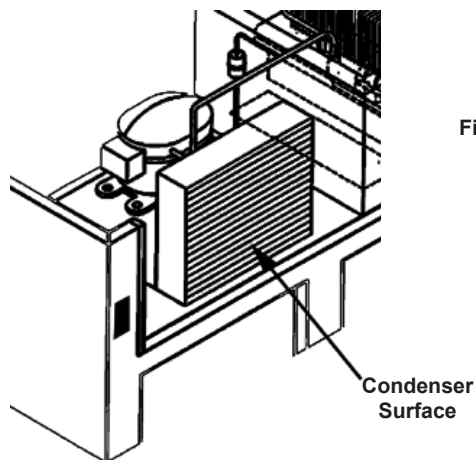

Fig. 10

Lower louver assembly and replace the screws to hold it in place.

### V. b - HINGE REPLACEMENT:

Both the door and hinge can be easily removed from the cabinet. To remove the door, remove the plug at the bottom of the top hinge. Inside the hinge there is a small screw which secures the door in place. Remove this with a flat head screwdriver and the door can then be lifted off the hinge. To remove the door portion of the hinge from the door, lift off the hinge cover and then remove the three Phillips head screws which secure the hinge in place on the door. To remove the cabinet portion of the hinge, remove the three Phillips head screws which hold it in place. On solid door units, the top hinge(s) contains a microswitch for controlling the interior lighting.

To reassemble the hinge reverse the previous procedure.

### V. c - REPLACING THE GASKETS:

To remove the gasket to be replaced, grasp it firmly by one corner and pull it out. Before attempting to install a new gasket, both the unit and the gasket itself must be at room temperature. Insert the four corners first by using a rubber mallet (or hammer with a block of wood).

### V. c - REPLACING THE GASKETS:

After the corners are properly inserted, work your way towards the center from both ends by gently hitting with a mallet until the gasket is completely seated in place (see figure 11 for proper gasket placement).

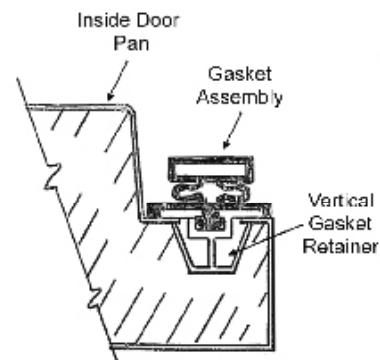

Fig. 11

NOTE: The gasket may appear too large, but if it is installed as indicated above it will slip into place.

### V. d - CLEANING THE EXTERIOR:

Exterior stainless steel should be cleaned with warm water, mild soap and a soft cloth. Apply with a dampened cloth and wipe in the direction of the metal grain.

Avoid the use of strong detergents and gritty, abrasive cleaners as they may tend to mar and scratch the surface. Do NOT use cleansers containing chlorine, this may promote corrosion of the stainless steel.

Care should also be taken to avoid splashing the unit with water, containing chlorinated cleansers, when mopping the floor around the unit.

For stubborn odor spills, use baking soda and water (mixed to a 1 TBSP baking soda to 1 pint water ratio).

### V. e - CLEANING THE INTERIOR:

For cleaning both stainless steel and anodized aluminum interiors, the use of baking soda as described in section "V. d" is recommended. Use on breaker strips as well as door gaskets. All interior fittings are removable without tools to facilitate cleaning.

### V. f - ADJUSTING THE SHELVES:

For shelves mounted on pins, first select the desired location and remove the white plastic covers in the interior back and sides by rotating them counter-clockwise. Remove the shelf pins by rotating them counter-clockwise. Install the pins in the desired location by rotating clockwise. Make sure the pin is securely tightened down. Do not over tighten. Slide the shelf into its new position, and replace the white plastic covers into the holes vacated by the shelf pins.

## V. CARE & MAINTENANCE (cont'd)

### V. g - REPLACING THE LIGHT BULB:

All Traulsen R & A Series models are supplied with incandescent lighting unless optional fluorescent lighting was ordered (except for sliding glass door models for which fluorescent lights are supplied standard).

The bulb is a 115 volt/40 watt, T-6 $\frac{1}{2}$  intermediate clear refrigerator lamp. It is mounted at the top front of the cabinet at the center, and is located behind a plastic light cover on refrigerator and freezer model.

Heated units (RHF/AHF/RIH/AIH/RDH/ADH/RIDH/AIDH) are equipped with a similar type bulb, however this is shatterproof because these models do not include a plastic light cover.

To replace the bulb, first remove the light cover (if so equipped). This can be accomplished by squeezing it together on both sides until it comes free. Replace the light bulb, then squeeze both sides of the light cover together and replace in its original position.

## VI. OTHER

### VI. a - SERVICE INFORMATION:

Before calling for service, please check the following:

- Is the electrical cord plugged in?
- Is the fuse OK or circuit breaker on?
- Is the power switch "ON"?

If after checking the above items and the unit is still not operating properly, please contact an authorized Traulsen service agent. A complete list of authorized service agents was provided along with your Traulsen unit. If you cannot locate this, you may also obtain the name of a service agent from the **SERVICE & PARTS** button from our website: [www.traulsen.com](http://www.traulsen.com).

If service is not satisfactory, please contact our in-house service department at:

Traulsen  
4401 Blue Mound Road  
Fort Worth, TX 76106  
(800) 825-8220

Traulsen reserves the right to change specifications or discontinue models without notice.

### VI. b - SPARE PARTS:

Spare or replacement parts may be obtained through a parts supplier or one of our authorized service agents. A complete list of authorized service agents is posted on our company's official website [www.traulsen.com](http://www.traulsen.com), under the **SERVICE & PARTS** button.

### VI. c - WARRANTY REGISTRATION:

For your convenience, the warranties on your new Traulsen unit may be registered with us on-line at [www.traulsen.com](http://www.traulsen.com), under the **SERVICE & PARTS** button.



## VII. The INTELA-TRAUL® Control System

Your new Traulsen Refrigerator, Freezer or Hot Food cabinet is equipped with a state-of-the-art electronic microprocessor INTELA-TRAUL® control, which precisely regulates operation and provides alarms when problems occur. It is supplied from the factory completely ready for use and requires no adjustment (except Hot Food units which are set in the “OFF” position, see page for 19 for more info), but without the audible alarms activated. See pages 9 thru 19 for more information.



### VII. a - INTELA-TRAUL® CONTROL FEATURES:

#### 1- Internal Time Clock

- Defrost cycle can be quickly adjusted to suit individual location and use.
- Must be set at power-up.
- Will automatically update for Daylight Savings Time.

**2- Water Resistant Housing** - The face of the control is water resistant to provide for protection during cleaning.

#### 3- Parameter/Service Levels

- See “**Customer / Service Parameters**” on Page 10.

**4- Defrost Lockouts** - See “**Setting Defrost Lockouts**” on page 16 (refrigerator and freezer models only).

- Customers can set up to 4 different defrost lockout periods. The lockout prevents the unit from going into a defrost cycle during peak kitchen use. **Note: The 24-hour clock must be set for this feature to operate correctly.**

**5- Anti-Condensate Door Perimeter Heater Control** (refrigerator and freezer models only)

“No-Sweat” feature is an energy savings system that allows the customer to set the percent of time for the door heater as needed for the prevailing ambient conditions (from 0 - 100% of the time each day). It is used to prevent condensation from forming around the perimeter of the doors.

#### 6- Alarms (See the following pages for explanations)

- High Cabinet Air Temperature
- Low Cabinet Air Temperature
- Loss Of Power
- Sensor Failure
- Door Open\*
- Clean Condenser (refrigerator and freezer models only)\*
- New Compressor Run Time, Defrost Error

\* Not available on remote models.

\*\* Not available on Fire-Rated or Sliding Door models.

#### 7- Display Features

- Door Open Icon
- 3-Digit LED Display
- Defrost in Progress Icon
- Fahrenheit or Celsius Temperature Scale In Use

## VII. INTELA-TRAUL® (continued)

### VII. a - **ALARM EXPLANATIONS:**

\***NOTE:** Explanation of alarms assume the audible alarm style is set at a 3-second burst or a continuous audible alarm. References to the audible alarm do not apply if the audible alarm style is set to OFF (Refer to page 18 for setting the audible alarm style).



**High Cabinet Air Temperature:** The audible alarm\* will sound and the display will read **cHI** when the temperature inside the cabinet rises above a pre-programmed limit. The limit is determined by the type of unit being operated (i.e.: refrigerator/freezer). To turn off the audible alarm\*, press the alarm cancel button. The visual alarm text will continue to display until the cabinet air temperature falls below the limit. If the temperature does not fall below the limit within 5 minutes, the audible alarm\* will sound again and an additional Call Service message will display.

**POSSIBLE CAUSES (for Refrigerator & Freezer Models):**

- Doors open for extended periods of time.
- Large amounts of hot product placed inside the cabinet.
- Condenser coil dirty.



**Low Cabinet Air Temperature:** The audible alarm\* will sound and the display will read **cLO** when the temperature inside the cabinet falls below a pre-programmed limit. The limit is determined by the type of unit being operated (i.e.: refrigerator/freezer). To turn off the audible alarm\*, press the alarm cancel button. The visual alarm text will continue to display until the cabinet air temperature rises above the limit. If the temperature does not rise above the limit within 5 minutes, the audible alarm\* will sound again and an additional Call Service message will display.

**POSSIBLE CAUSES (for Refrigerator & Freezer Models):**

- No product in unit.
- Failed sensors.



**Loss Of Power:** The audible alarm\* will sound and the display will read Electrical Loss, when the unit regains power after an outage. To turn off the audible alarm\* and/or clear the visual text, press the alarm cancel button.



**Door Open:** The display will read Door Open and the audible alarm will sound, after the door or doors have been open for 15 minutes. To turn off the alarm, **close the door** or press the alarm cancel button. If the door remains open for an additional 5 minutes, the audible alarm\* will sound again (n/a on fire-rated and sliding glass door models).



**CONDENSER CLEAN™:** The audible alarm\* will sound and the display will read Clean Filter, when the operating pressures and temperatures exceed a safe operating range. As the load on the condenser decreases, the alarm will turn off by itself. As the pressures on the condenser continues to rise, the audible alarm\* will stay on for longer periods of time. To turn off the audible alarm\*, press the alarm cancel button. The visual alarm text will remain until the filter/condenser has been cleaned. If the condition remains for 24 hours, the audible alarm\* will sound again and visual display will read Call Service.

**POSSIBLE CAUSES:**

- Inadequate air flow through condenser unit.
- Discharge sensor has failed high.



**Sensor Failures:** The audible alarm\* will sound and the display will read **SN1, SN2, SN3** when any of the unit sensors fail to operate. To turn off the audible alarm\*, press the alarm cancel button. The visual alarm text will remain until the sensor has been replaced. Depending on the function of the sensor, the audible alarm\* will sound again in either 5 minutes or 24 hours.  
**\*Not available on remote models.**



**Run Error:** The audible alarm will sound and the display **rUn Err** when the compressor has run continuously for over 24 hours. To turn off the audible alarm, press the alarm cancel button. The visual text will remain until the issue is fixed.



**Defrost Error:** The audible alarm will sound and the display will read **DEF Err** when defrost does not terminate on temperature during a 36 hour period.

## VII. INTELA-TRAUL® (continued)

### VII. c - CONTROL PANEL:

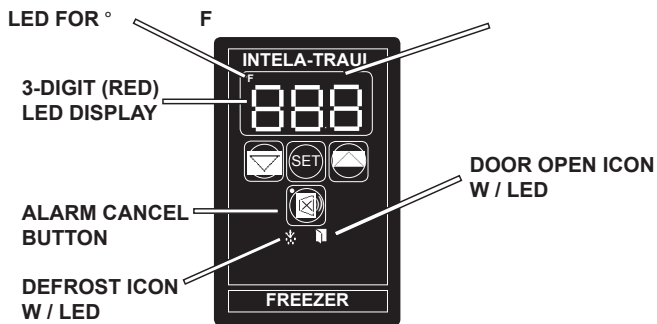



### VII. d - NOTES TO THE USER:

You only have 20-30 seconds between button pushes. If you take longer than 30 seconds, the controller will revert back to displaying the cabinet temperature. If you enter the wrong security code, the controller will revert back to displaying the cabinet temperature. You can exit the parameters at any time by pressing the alarm cancel button or by waiting 20-30 seconds.

### VII. e - ENTER THE CUSTOMER ACCESS: This is required to set any of the control parameters

Use the security code 0, A, 1  and the following instructions:

Press the set button  . The display will read  Customer/Service Access.

Press the set button  .

The display will show three zeros with the left zero flashing  .

Press the set button  .

The display will show three zeros with the center zero flashing  .



Press the down arrow key  to sequence through F, E, d, C, b, A, 9, 8, 7,...etc.

When you reach A press set  .

The display will show zero, A, zero with the right zero flashing  .

Press the up arrow key  to sequence through 1, 2, 3, 4, 5, 6, 7, 8, 9, A, b,...etc.

When you reach 1 press set  .

















The display will read  Thermostat Set Point. Press  to view and  again to exit.

You are now in the **CUSTOMER / SERVICE PARAMETERS**.

## VII. INTELA-TRAUL® (continued)

### VII. f - CUSTOMER SERVICE PARAMETERS:

Listed below are the available parameters in the order they appear, using the down arrow key on the controller. You can use either the up or down arrow keys to scroll through the options.



	Thermostat Set Point		Defrost Lockout 2
	Set Point Differential		Defrost Lockout 3
	Temperature Scale*		Defrost Lockout 4
	Audible Alarm Style*		Dew Point Compensation Factor*
	Time (24-hour clock)*		Room Temperature Offset
	Date (month - day - year)*		Evaporator Coil Sensor
	Daylight Savings *		Discharge Line Sensor
	Defrost Lockout 1		Start Manual Defrost
	Cabinet Air Sensor Temp		



\*Available on Hot Food units.

### VII. g - ADJUSTING THE THERMOSTAT SET POINT:

This parameter sets the low point of the desired cabinet temperature range. Typically, freezers will range from -4° F to 0° F (-19° C to -18° C) and refrigerators will range from 36° F to 40° F (2° C to 4° C) for this parameter setting. This parameter is preset at the factory and does not have to be adjusted unless the customer chooses to do so.



Follow the instructions to enter the customer access code on page 10. When the control

display reads  Thermostat Set Point. Press the set button .

Use the arrow keys   to adjust the temperature to your desired setting.

When the display shows the temperature you want press the set button .

The display will then read  Thermostat Set Point.

You can use the up or down arrow keys to scroll to the next parameter  .





or press the alarm cancel button to exit .



## VII. INTELA-TRAUL® (continued)

### VII. h - ADJUSTING THE THERMOSTAT SET POINT Differential:

This parameter sets the set point differential of the desired cabinet temperature range. Typically, freezers and refrigerators will range from 2° F to 5° F for this parameter setting. This parameter is preset at the factory and does not have to be adjusted unless the customer chooses to do so. Set point differential determines the cabinet temperature at which the compressor come on.



Follow the instructions to enter the customer access code on page 10. When the control

displays  Thermostat Set Point, press the down arrow key  until the control display reads  Thermostat Set Point Differential. Press the set button  .

Use the arrow keys   to adjust the temperature to your desired setting.

When the display shows the temperature you want press the set button  .





The display will then read  Thermostat Set Point.





You can use the up or down arrow keys to scroll to the next parameter   or press the alarm cancel button to exit  .

### VII. i - CHANGING THE TEMPERATURE SCALE:

The temperature scale determines if the temperature displayed will be in degrees Fahrenheit or degrees Celsius.

Follow the instructions to enter the customer access code on page 10. When the control

displays  Thermostat Set Point, press the down arrow key  until the control display reads  Temperature Scale. Press the set button  .

The display will start with the current setting either  for degrees Fahrenheit or  for degrees Celsius. Use the arrow keys   to toggle between the options.

When the display shows the scale you want press the set button  .

The display will then read  Thermostat Set Point.

You can use the up or down arrow keys   to scroll to the next parameter or press the alarm cancel button to exit  .





## VII. INTELA-TRAUL® (continued)



### VII. j - SETTING THE 24-HOUR CLOCK:

The internal timeclock must be set in order for the data storage memory to correctly log events and to allow any defrost lockout to occur at the correct time of day. If the clock is not set, the control assumes the time is 12 a.m. at the time power is supplied to the unit. The hours on a 24-hour time clock read the following way:

H01 = 1:00 a.m.	H07 = 7:00 a.m.	H13 = 1:00 p.m.	H19 = 7:00 p.m.
H02 = 2:00 a.m.	H08 = 8:00 a.m.	H14 = 2:00 p.m.	H20 = 8:00 p.m.
H03 = 3:00 a.m.	H09 = 9:00 a.m.	H15 = 3:00 p.m.	H21 = 9:00 p.m.
H04 = 4:00 a.m.	H10 = 10:00 a.m.	H16 = 4:00 p.m.	H22 = 10:00 p.m.
H05 = 5:00 a.m.	H11 = 11:00 a.m.	H17 = 5:00 p.m.	H23 = 11:00 p.m.
H06 = 6:00 a.m.	H12 = 12:00 p.m.	H18 = 6:00 p.m.	H24 = 12:00 a.m.

Follow the instructions to enter the customer access code on page 10. When the control

displays  Thermostat Set Point, press the down arrow key  until the control



display reads  Clock. Press the set button .

The display will show  Hours. The right two numbers will be flashing.

Use the arrow keys   to set the hour.

When the correct hour is displayed, press the set button .

The display will show  Minutes. The right two numbers will be flashing.

Use the arrow keys to set the minutes  .

When the correct minutes are displayed, press the set button .





















The display will then read  Thermostat Set Point.

You can use the up or down arrow keys   to scroll to the next parameter















or press the alarm cancel button to exit .

## VII. INTELA-TRAUL® (continued)

### VII. k - SETTING THE DATE:

The date must be set in order for the data storage memory to correctly log events. Follow the instructions to enter the customer access code on page 10. When the control displays  Thermostat Set Point, press the down arrow key  until the control display reads  Date. Press the set button . The display will show  (year). The right two numbers will be flashing. Press the arrow keys   to set the year. When the correct year is displayed, press the set button . The display will show  (month). The right two numbers will be flashing. Use the arrow keys   to set the month. When the correct month is displayed, press the set button . The display will show  (day). The right two numbers will be flashing. Press the arrow keys   to set the day. When the correct day is displayed, press the set button . The display will then read  Thermostat Set Point. You can use the up or down arrow keys   to scroll to the next parameter, press the alarm cancel button to exit .

### VII. l - SETTING DAYLIGHT SAVINGS TIME:



This parameter is preset at the factory to automatically adjust the 24-hour clock for Daylight Savings Time. Follow the instructions to enter the customer access code on page 10. When the control displays  Thermostat Set Point, press the down arrow key  until the display reads  Daylight Savings Time. Press the set button . The display will show  Daylight Savings Time (Yes, automatically adjust for Daylight Savings Time). For “YES,” press the set button , for “NO” press the up or down arrow key  . The display will read  Daylight Savings Time (no). Press the set button . The display will read  Thermostat Set Point. You can press the the up or down arrow keys   to scroll to the next parameter or press the alarm cancel button to exit .

## VII. INTELA-TRAUL® (continued)

### VII. m - STARTING A MANUAL DEFROST CYCLE:



This parameter allows a service technician to start a defrost cycle at any time. This parameter will override any lockout settings.

Follow the instructions to enter the customer access code on page 10. When the control

displays  Thermostat Set Point, press the down arrow key  until the control display reads  Start Manual Defrost.

Press the set button .

The display will show  (OFF).

Press either arrow key   (ON).

The display will show .

Press the set button .

The display will then read  and start the defrost cycle immediately.

### Reach-In/Roll-In Models



The defrost icon will be lit, and the display will read  when the unit is in defrost.

**NOTE:** Traulsen refrigerator units also have an off-cycle defrost once an hour, at which time the control will read . This defrost is time terminated and can last 10 minutes (dEF will be displayed for 22-27 minutes).

## VII. INTELA-TRAUL® (continued)

### VII. n - SETTING THE DEFROST LOCKOUTS:

The defrost lockout parameters allow the customer to prevent the unit from going into a defrost cycle for two hours during a set timeframe. Customers can set up to four defrost lockout parameters. They are all programmed the same way. The parameters will be set for the time the lockout is to start. The controller automatically calculates 2 hours from that setting. The options are similar to the 24-hour clock settings and are in 30-minute increments. Each of the lockout parameters covers 6 hours of the 24-hour clock. Note: The 24-hour clock must be set for this feature to operate at the correct time of day. See “**Setting the 24-Hour Clock**” on page 13.

Sample:



OFF

020 = 2:00 a.m.

023 = 2:30 a.m.

030 = 3:00 a.m.

033 = 3:30 a.m.

040 = 4:00 a.m.

043 = 4:30 a.m.

050 = 5:00 a.m.

053 = 5:30 a.m.

060 = 6:00 a.m.

063 = 6:30 a.m.

070 = 7:00 a.m.

073 = 7:30 a.m.

080 = 8:00 a.m.



OFF

080 = 8:00 a.m.

083 = 8:30 a.m.

090 = 9:00 a.m.

093 = 9:30 a.m.

100 = 10:00 a.m.

103 = 10:30 a.m.

110 = 11:00 a.m.

113 = 11:30 a.m.

120 = 12:00 p.m.

123 = 12:30 p.m.

130 = 1:00 p.m.

133 = 1:30 p.m.

140 = 2:00 p.m.



OFF

140 = 2:00 p.m.

143 = 2:30 p.m.

150 = 3:00 p.m.

153 = 3:30 p.m.

160 = 4:00 p.m.

163 = 4:30 p.m.

170 = 5:00 p.m.

173 = 5:30 p.m.

180 = 6:00 p.m.

183 = 6:30 p.m.

190 = 7:00 p.m.

193 = 7:30 p.m.

200 = 8:00 p.m.



OFF

200 = 8:00 p.m.

203 = 8:30 p.m.

210 = 9:00 p.m.

213 = 9:30 p.m.

220 = 10:00 p.m.

223 = 10:30 p.m.

230 = 11:00 p.m.

233 = 11:30 p.m.

240\* = 12:00 a.m.

243\* = 12:30 a.m.

010 = 1:00 a.m.



013 = 1:30 a.m.

020 = 2:00 a.m.



\* Denotes not available.

A lockout cannot be programmed to start at 12:00 a.m. or 12:30 a.m. due to conflicts with other internal programs. The defrost lockouts cannot be programmed to run back-to-back. For example, if dL1 is set to 080, then a defrost cycle would be locked out from 8:00 a.m. to 10:00 a.m. Because of the dL1 setting the dL2 parameter would not let the user choose a lockout start time before 10:30 a.m. All lockouts are preset at the factory to OFF.

Follow the instructions to enter the customer access code on page 10. When the control

displays  Thermostat Set Point, press the down arrow key  until the control the

control display reads    or . Press the set button .

The display will show  Off. Press the arrow keys   to set the start time.

When the correct time is displayed, press the set button .

The display will then read  Thermostat Set Point.

You can press the up or down arrow keys   to scroll to the next parameter

or press the alarm cancel button to exit .

## VII. INTELA-TRAUL® (continued)

### VII. o - ADJUSTING THE ROOM TEMPERATURE OFFSET:



The room temperature offset parameter allows a service technician or end user the ability to have the display show a temperature that is within three degrees of the actual temperature being read by the cabinet air sensor. This allows for continuity of reading between different temperature reading devices. (i.e.: thermistor Vs thermocouple Vs hand held thermometer) This parameter is preset at the factory to "0" or no offset.

Follow the instructions to enter the customer access code on page 10. When the control displays

 Thermostat Set Point, press the down arrow key  until the control display reads 

Room Temperature Offset. Press the set button . Use the arrow keys   to adjust the offset to your desired setting. When the display shows the offset you want press the set button .





The display will then read  Thermostat Set Point. You can use the up or down arrow keys





  to scroll to the next parameter or press the alarm cancel button to exit .

### VII. p - SETTING THE AUDIBLE ALARM STYLE:



This parameter will allow the customer to turn on/off the audible alarm feature on the INTELA-TRAUL® control. The audible alarm is preset from the factory to OFF. The customer can choose between an audible alarm that sounds for 3 seconds then automatically turns off, or a continuous audible alarm that must be manually acknowledged. Regardless of this feature's setting, visual alarm text will display when conditions warrant.

To adjust this setting, follow the instructions to enter the customer access code on page 10. When

the control displays  Thermostat Set Point, press the up arrow key  until the display reads  Audible Alarm Style. Press the set button . The display will read  OFF.

Use the arrow keys   to scroll between  for the 3-Second Audible Alarm Burst or  for Continuous Audible Alarm. When the display shows your choice of style, press the set

button . The display will then read  thermostat Set Point. Use the arrow keys 

 to scroll to the next parameter or press the Alarm Cancel Button  to exit.









## VII. INTELA-TRAUL® (continued)

### VII. q - VIEWING SENSOR TEMPERATURES:

These parameters allow a service technician or customer to view the temperature of all sensors within the unit. The temperatures cannot be adjusted.

Follow the instructions to enter the customer access code on page 10. When the control displays

Thermostat Set Point  , press the DOWN arrow key  until the display reads  Cabinet Air Sensor, Evaporator Coil Sensor,  and Discharge Line Sensor  or press the SET button  . The display will read Thermostat Set Point  .

Press the UP or DOWN arrow keys   to scroll through the parameters or press the ALARM CANCEL button  to exit.

### VII. r - DOOR OPEN ICON:









The door open icon is located on the control face, directly below the Alarm Cancel button (On/Off button for heated cabinet models). This feature illuminates on all solid and hinged glass door models<sup>1</sup> whenever one or more of the doors is opened, and stops illuminating upon all doors being closed. There are no operator adjustable parameters for this feature.

<sup>1</sup>= This feature is not included on either fire-rated or sliding glass door models.

### VII. s - HOT FOOD UNITS. ADJUSTING THE THERMOSTAT & TURNING THE UNIT OFF/ON:

This parameter sets the desired cabinet temperature. Please note that hot food units are delivered from the factory set to the OFF position.



Follow the instructions to enter the customer access code on page 10. When the control reads

 Thermostat Set Point, press the set button  . Use the arrow keys   to adjust the temperature to your desired setting. When the display shows the temperature you want press the set button  . The display will then read  Thermostat Set Point. You can use the up or down   arrow keys to scroll to the next parameter or press the alarm cancel button  to exit.





## VII. INTELA-TRAUL® (continued)

### VII. t - HOT FOOD UNITS. TURNING THE UNIT OFF/ON:

After the temperature has been set, the customer can continuously turn the unit OFF and then back ON to the same temperature. To turn the unit ON /OFF press the alarm cancel button  , (please note that this feature is not available on versions of the control manufactured prior to September 2000), or if an alarm warning condition is present, use the alternative ON/OFF activation method.

To turn the unit ON/OFF using the alternative method, press both arrows   at the same time, the set temperature will remain in memory.

### VII. v - HOT FOOD UNITS. TEMPERATURE ADJUSTMENT:

Press the **SET** button  and the **UP ARROW** button  at the same time. The display will flash the current temperature setting or **OFF** (if the unit is turned off). Use the **UP**  or **DOWN ARROW**  buttons to adjust your desired temperature setting (temperature range is 140° - 180° F, and OFF) then press the **SET** button . The display will go back to reading cabinet temperature. If **OFF** is selected the display will then read **OFF**. **NOTE:** If you wish to change the set temperature at anytime follow this procedure.

These models also include a “One-Time Temperature Setting Adjustment” feature. Upon start-up, the unit will warm-up to the last temperature you had set for it, unless changed.

## VIII. TROUBLE SHOOTING GUIDE

FIND YOUR PROBLEM HERE	REMEDY
1. Condensing unit fails to start.	<ul style="list-style-type: none"> <li>a. Check if cord &amp; plug has been disconnected.</li> <li>b. Check INTELA-TRAUL® temperature setting.</li> </ul>
2. Condensing unit operates for prolonged periods or continuously.	<ul style="list-style-type: none"> <li>a. Are doors closing properly?</li> <li>b. Dirty condenser or filter. Clean properly.</li> <li>c. Evaporator coil iced. Needs to defrost. See instructions for setting a manual defrost cycle on page 15.</li> <li>d. Shortage of refrigerant, call service.</li> </ul>
3. Food compartment is too warm.	<ul style="list-style-type: none"> <li>a. Check door(s) and gasket(s) for proper seal</li> <li>b. Perhaps a large quantity of warm food has recently been added or the door was kept open for a long period of time, in both cases, allow adequate time for the cabinet to recover its normal operating temperature.</li> <li>c. INTELA-TRAUL® setting too high, readjust per instructions on page 11.</li> </ul>
4. Food compartment is too cold.	<ul style="list-style-type: none"> <li>a. Perhaps a large quantity of very cold or frozen food has recently been added. Allow adequate time for the cabinet to recover its normal operating temperature.</li> <li>b. Adjust the INTELA-TRAUL® to a warmer setting, see page 12.</li> </ul>
5. Condensation on the exterior surface.	<ul style="list-style-type: none"> <li>a. Check door alignment and gaskets for proper seal.</li> <li>b. Condensation on the exterior surface of the unit is perfectly normal during periods of high humidity. However, to alleviate the condition, adjust the INTELA-TRAUL® "Dewpoint Compensation Factor," see page 17.</li> </ul>
6. Compressor hums but does not start.	<ul style="list-style-type: none"> <li>a. Call for service.</li> </ul>
7. Door open icon continually illuminated.	<ul style="list-style-type: none"> <li>a. Door open, close door.</li> <li>b. Faulty door switch, replace door switch.</li> </ul>
8. Door open icon does not illuminate.	<ul style="list-style-type: none"> <li>a. Faulty door switch, replace door switch.</li> </ul>
9. Evaporator fans not operating.	<ul style="list-style-type: none"> <li>a. Defrost cycle in progress (freezers only).</li> <li>b. Other, contact service.</li> </ul>

## XI. SPARE PARTS LIST

PART	PART #	DESCRIPTION
Bulb, Fluorescent	337-27690-00	Replacement bulb for fluorescent light models
Bulb, Incandescent	378-29776-00	Replacement bulb for incandescent light models
Bulb Cover	337-30858-00	Replacement bulb cover for incandescent light models
Caster, 6" High	344-13140-01	Optional caster for all reach-in models
Caster, 4" High W/O Brake	SMO-28627-00	Optional lower height caster
Caster, 4" High W/Brake	SMO-28628-00	Optional lower height caster
Caster Bolt (4 req'd per caster)	351-25542-00	Bolt for above
Door Handle, Stainless Steel	344-37690-00	Replacement handle for solid door units
Door Lock, Sliding Glass	346-60005-00	Jewelers type door lock for sliding glass door model
Hinge Cam	344-28488-00	Replacement hinge cam
Hinge Cover	344-28486-00	Replacement hinge cover
Hinge, Spring Assist	SER-29021-03	Alternative hinge, spring assist
Hinge Assembly W/Stop Feature	SER-40677-02	Alternative hinge, stop feature
Hinge Assembly	SER-28583-00	Replacement hinge assembly
Key, Master	346-29467-00	Replacement key for solid door units
Leg, 4" High Adjustable	344-29558-00	Replacement or optional leg
Leg, 6" High Adjustable	344-13168-01	Replacement leg
Shelf Pin	344-24759-02	Replacement shelf pin
Shelf Clip	344-08982-00	Replacement shelf clip for pilasters
Tray Slide, #4 Chrome Rod Type	340-04842-00	Tray slide for rim support of 18" x 26" pan
Tray Slide, Universal	719-07805-00	Tray slide for 18" x 26", 14" x 18" or 12" x 20" pan
Tray Slide, #1	719-20236-00	Tray slide for 18" x 26" or 14" x 18" pan
Coil Sensor	337-60071-02	Coil Sensor For Microprocessor Control
Discharge Sensor	337-60072-02	Discharge Line Sensor For Microprocessor Control
Cabinet Sensor	337-60069-02	Cabinet Sensor For Microprocessor Control
Horn	337-60070-00	Horn For Audible Control Alarms

## XII. STAINLESS STEEL OVERVIEW

### XII. a - INTRODUCTION:

All Traulsen R & A Series Refrigerator, Freezer, Dual-Temp and Heated Cabinet models are constructed with a high quality 430 series, 20 gauge stainless steel exterior finish (front, sides and doors). The interior finish on these same R-Series models are constructed using 300 series stainless steel (anodized aluminum is used for A-Series).

The stainless steel finish on Traulsen R & A Series should retain its appearance throughout the products usable lifetime. However, some care is required to maintain this appearance. The following paragraphs will provide a guideline on proper care of the exterior/interior finish, as well as some suggestions on how to repair a finish which has been marred due to adverse environmental conditions or improper jobsite care.

### XII. b - STAINLESS STEEL, HOW IT WORKS:

The process by which stainless steel retains its appearance is a result of its type of metal alloy. Steel is a composite of metals combined in a specific industrial process. Stainless steel contains a high percentage of chromium, the addition of which provides both its appearance, and a microscopic surface layer protecting the steel underneath from corrosion. This external layer acts as a barrier, preventing typical oxidation of the steel. Remove this barrier, and the environment will eventually corrode the metal, marring its appearance.

### XII. c - UNDERSTANDING THE CAUSES OF CORROSION:

Corrosion to stainless steel can only be caused in one of four specific ways:

#### 1) **ABRASION**

Abrasion can be caused during routine cleaning of the metal, either by use of an abrasive cleanser, or use of an abrasive device, such as a metal scouring pad. Abrasion can also be caused by contact with other hard surfaces, such as nearby equipment, walls or tools. Special care should be taken to position your unit properly to prevent accidental dents and scratches.

#### 2) **WATER**

Water everywhere contains various deposits, or solids, which as the water dries or evaporates, can leave spots behind. The spots may eventually cause corrosion if not removed.

#### 3) **CHEMICALS OR WATER CONTAINING CHLORIDES**

Chlorides, such as found in water or many cleaning materials are especially corrosive to stainless steel. Daily janitorial duties, such as floor mopping, can splash water containing chlorinated cleansers against the front and sides of a Traulsen refrigeration product, resulting in corrosion. Avoid use of these on or around a Traulsen refrigeration product if at all possible.

### XII. c - UNDERSTANDING THE CAUSES OF CORROSION:

#### 4) **PROLONGED CONTACT WITH FOOD PRODUCT**

Many food products, such as milk and carbonated sodas, contain acids which may damage the protective layer of stainless steel. All food and beverage spills should be cleaned up promptly to avoid possible stains and corrosion.

## XIII. CARE OF STAINLESS STEEL

### XIII. a - USING THE PROPER TOOLS:

Use of proper cleaning materials will do much to prolong the appearance of your Traulsen refrigeration product. We particularly encourage the use of either plastic scouring pads or soft cloths for cleaning stainless steel.

Soft nylon scouring pads can also be used, however care has to be used to insure that all scrubbing is done in the direction of the metals "GRAIN." Because metals are crystalline in nature, when they are in a solid state the individual ions line up to form visible grain lines. Use of a soft nylon scouring pad in a direction opposite of the grain will mar its luster. Always do so "PARALLEL" to the grain.

There are several types of tools which should **NEVER BE USED** when cleaning stainless steel, these include:

- WIRE BRUSHES
- METAL SCOURING PADS
- SANDPAPER
- SCRAPERS & PUTTY KNIVES

Use of any of these tools will result in scratches or removal of the stainless steel's protective layer, which will eventually lead to corrosion and rust.

### XIII. b - USING THE RIGHT CLEANSER:

Avoid all cleaning products containing chloride ingredients. Use of a cleanser specifically designed for stainless steel is highly recommended. You may find yourself in a situation where you are uncertain if a particular cleaning product contains any chlorides. If unsure, it's probably best to just assume that it does and avoid its use in cleaning a Traulsen refrigeration product.

Also to be avoided are cleaning products which contain "QUATERNARY SALTS." These salts can literally attack the stainless steel's protective layer, leading to corrosion and pitting of the steel's surface.

After cleaning, it is important to always rinse the cleaned area thoroughly with cool, clean water (do not use hot water) and wipe completely dry using a paper towel or soft absorbent cloth.

Use of cleaning products designed for use on stainless steel, in conjunction with the proper tools, as outlined above will help retain the appearance of your Traulsen refrigeration product for years and years.



### **XIII. CARE OF STAINLESS STEEL(cont'd)**

#### **XIII. c - CLEANING SUMMARY - DO'S & DONT'S:**

To summarize the proper cleaning of Traulsen refrigeration products, always follow the below guidelines.

- DO** use only cleaning products designed for stainless steel, or cleaning products which do not contain chlorides.
- DO** use only non-abrasive cleaning materials, such as soft cloths or plastic scouring pads.
- DO** clean-up food and beverage spills ASAP.
- DO** scrub only in the direction of the grain when using soft nylon scouring pads.
- DON'T** use chlorinated cleansers or cleansers containing quaternary salts.
- DON'T** use abrasive cleaning materials or tools which can scratch the stainless steel's surface.

#### **XIII. d - DEALING WITH ACCIDENTAL CHLORIDE CONTACT:**

In the daily routine of a busy foodservice operation, your Traulsen refrigeration product may occasionally come in contact with chlorinated cleaners, such as when being splashed during mopping. Stain and corrosion problems resulting from this can be avoided by prompt action to remove this cleanser. Rinse the affected area(s) thoroughly with cool, clean water (do not use hot water) and wipe completely dry using a paper towel or soft absorbent cloth.

#### **XIII. e - PROTECTING THE STAINLESS STEEL SURFACE:**

Occasional use of a commercial stainless steel polish, such as "Sheila Shine," will help protect the surface of stainless steel. Follow the directions on the spray can for proper use.

### **XIV. CORROSION REMEDIES**

#### **XIV. a - DEALING WITH RUST AFTER THE FACT:**

Although Traulsen strongly recommends proper care and cleaning of stainless steel finishes in order to avoid rust and corrosion before it occurs, we recognize that it may occur occasionally as a result of the causes described in section one of this booklet.

To remove small quantities of rust from the surface of stainless steel, it is far preferable to deal with this when it first becomes visible. When rust occurs, do not allow it to remain for any period of time, and remove it using the following method:

**STEP ONE** - Use a lightly abrasive compound (free of harmful chlorides), such as "Bon Ami," on a soft cloth, to remove the rust. Care must be taken to rub this on the area of rust only in the direction of the stainless steel's grain.

**STEP TWO** - Once the rust is removed, clean the affected area thoroughly with a stainless steel cleaner (see sections II. a & b).

### **XIV. CORROSION REMEDIES**

#### **XIV. a - DEALING WITH RUST AFTER THE FACT (cont'd):**

**STEP THREE** - Apply a preservative polish, such as "Sheila Shine," to the affected area (see section II. e).

#### **XIV. b - DEALING WITH EXTREME RUST SITUATIONS:**

In the event that rust and corrosion were not dealt with promptly, more acute situations can be remedied as follows:

**NOTE: PROCEDURE REQUIRES USE OF AN ACID BASED SOLUTION - USE OF PROTECTIVE GLOVES AND EYEWEAR ARE REQUIRED BEFORE PROCEEDING**

**STEP ONE** - In a clean spray bottle combine water with "Zep FS Lime Remover" to make a 5 parts to 1 solution.

**STEP TWO** - Apply this solution to the affected area with either a clean cloth or sponge.

**STEP THREE** - After application, wipe the same area thoroughly clean with water only to remove any residue.

**STEP FOUR** - Once cleaned, apply a light coat of "Zep Restore" to the surface area. This will serve to preserve the metal and help prevent future rust from occurring.

**STEP FIVE** - Restore the remaining stainless steel surfaces to their original shine using "Zep Stainless Steel Polish."

Repeat steps one thru five if necessary for stubborn rust and corrosion areas.

#### **XIV. c - RESTORING THE PROTECTIVE LAYER:**

There are several products available on the market today which can actually help restore the "PASSIVATION" of stainless steel. "PASSIVATION" refers to the protective qualities of the non-reactive surface layer of stainless steel which prevents oxidation. Contact your cleaning supplier for product recommendations and more information.

## XV. WARRANTY INFORMATION



### **STANDARD DOMESTIC WARRANTY** (this warranty applies to units manufactured after January 01, 2013)

TRAULSEN warrants new equipment to the original purchaser, when installed within the United States against defective material and workmanship for three (3) years from the date of original installation. Under this warranty, TRAULSEN will repair or replace, at its option, including service and labor, all parts found to be defective and subject to this warranty. Warranty term begins upon the date of Installation, the date of End User Invoice or the date of Dealer Invoice, whichever is proven to occur latest, not to exceed 18 months from Dealer Invoice date (the "Warranty Period"). Warranty excludes components that are removable without tools.

The compressor part is warranted for an additional two (2) years. During this period TRAULSEN will supply replacement compressor(s) if deemed defective, however all installation, recharging and repair costs will remain the responsibility of the owner.

This warranty does not apply to damage resulting from fire, water, burglary, accident, abuse, misuse, transit, acts of God, terrorism, attempted repairs, improper installation by unauthorized persons, and does not apply to food loss.

For Traulsen units purchased with a remote feature, standard warranty will apply only to those components contained within the unit to the point of connection of the refrigeration lines leading to the remote condenser.

"Defective Part Return" – All claimed defective replacement part(s) must be returned to TRAULSEN for inspection within 30 days from the date of the repair. Failure to return all claimed defective part(s) to TRAULSEN will invalidate the warranty claim, this warranty statement, and forfeit payment for those repairs affected.

### **INTERNATIONAL COMMERCIAL WARRANTY**

TRAULSEN warrants to the original purchaser the Refrigeration Equipment shall be manufactured free from defects in material and workmanship under normal use and service for a period of one (1) year from date of shipment. Under this warranty, TRAULSEN will reimburse the purchaser for the replacement of any part of said equipment (excluding dryers & refrigerant gas) which then proves to be defective. This warranty does not apply to damage resulting from fire, water, burglary, accident, abuse, misuse, transit, acts of God, terrorism, attempted repairs, improper installation by unauthorized persons, and will not apply to food loss.

TRAULSEN'S standard warranty does not apply to Export Sales. Rather, for a period of one (1) year from date of original installation not to exceed Fifteen (15) months from date of shipment from factory, TRAULSEN: will, at Traulsen's sole discretion, replace or repair, F.O.B. factory, any defective parts normally subject to warranty and will not cover the cost of packing, freight or labor, such costs being the sole responsibility of the dealer.

**THERE ARE NO ORAL, STATUTORY OR IMPLIED WARRANTIES APPLICABLE TO TRAULSEN, INCLUDING BUT NOT LIMITED TO, ANY IMPLIED WARRANTY OF MERCHANTABILITY OR FITNESS FOR ANY PARTICULAR PURPOSE WHICH EXTEND BEYOND THE DESCRIPTION ON THE FACE HEREOF. TRAULSEN SHALL HAVE NO OBLIGATION OR LIABILITY FOR CONSEQUENTIAL OR SPECIAL DAMAGES, INCLUDING, BUT NOT LIMITED TO, INDIRECT, PUNITIVE DAMAGES, LOSS OF USE, LOSS OF PRODUCT, DOWN TIME OR LOST PROFITS, GROWING OUT OF OR WITH RESPECT TO THE EQUIPMENT OR ITS SALE, OPERATION OR USE, AND TRAULSEN NEITHER ASSUMES NOR AUTHORIZES ANYONE ELSE TO ASSUME FOR IT ANY OBLIGATION OR LIABILITY IN CONNECTION WITH THE EQUIPMENT OR ITS SALE, OPERATION OR USE OTHER THAN AS STATED HEREIN.**

**THIS WARRANTY IS IN LIEU OF ALL OTHER WARRANTIES EITHER EXPRESSED OR IMPLIED AND CONSTITUTES TRAULSEN'S FULL OBLIGATION AND LIABILITY. WARRANTIES NOT AVAILABLE ON REMOTE MODELS.**

**HOURS OF OPERATION:**

Monday thru Friday 7:30 am - 4:30 pm CST



Quality Refrigeration

**Traulsen**

4401 Blue Mound Road Fort Worth, TX 76106  
Phone: (800) 825-8220 Fax-Svce: (817) 740-6757  
Website: [www.traulsen.com](http://www.traulsen.com)