

Traulsen & Co., Inc.



Quality Refrigeration

OWNER'S MANUAL

Instructions for the installation, operation
and maintenance of all Traulsen:

UC Series Full-Size Undercounter Refrigerators

UC Series Full-Size Undercounter Freezers

UL Series Shorty Cooktop Refrigerators

This Traulsen unit is built to our highest quality standards. We build our refrigerators, freezers and heated cabinets this way as a matter of pride. This philosophy has made Traulsen the leader in commercial refrigeration since 1938. We thank you for your choice and confidence in Traulsen equipment and we know you will receive many years of utility from this equipment.

All Traulsen units are placed on a permanent record file with the service department. In the event of any future questions you may have, please refer to the model and serial number found on the name tag affixed to the unit. Should you need service, however, call us on our toll free number, 800-825-8220 between 7:30 am and 4:30 pm CST, Monday thru Friday. It is our pleasure to help and assist you in every possible way.

INSTALLER

COMPLETE THE FOLLOWING INFORMATION PRIOR TO UNIT INSTALLATION

INITIAL START DATE: _____ SERIAL NO. _____

MODEL TYPE: _____

COMPANY/INDIVIDUAL NAME: _____

INSTALLER: _____

TABLE OF CONTENTS

I. THE SERIAL TAG	Page 1	VII. INTELA-TRAUL	
II. RECEIPT INSPECTION	Page 2	a-Control Features	Page 7
III. INSTALLATION		b-Alarm Explanations	Page 8
a-Location	Page 2	c-Control Panel	Page 9
b-Packaging	Page 2	d-Parts Assembly	Page 9
c-Installing Legs	Page 2	e-Notes To The User	Page 10
d-Installing Casters	Page 3	f-Enter The Customer Access Code	Page 10
e-Shelf Pins	Page 3	g-Customer Service Parameters	Page 11
f-Cord & Plug	Page 3	h-Adjusting Thermostat Set Point High	Page 11
g-Power Supply	Page 3	i-Adjusting Thermostat Set Point Low	Page 12
h-Wiring Diagram	Page 3	j-Changing The Temperature Scale	Page 12
i-Placing Equipment On Top Of Cabinet	Page 3	k-Setting The 24-Hour Clock	Page 13
IV. OPERATION		l-Setting The Date	Page 14
a-Refrigerators	Page 3	m-Setting Daylight Savings Time	Page 14
b-Freezers	Page 3/4	n-Starting A Manual Defrost	Page 15
c-Condensate Removal	Page 4	o-Setting Defrost Lockouts	Page 16
V. CARE & MAINTENANCE		p-Adjusting The Dewpoint Compensation Factor	Page 17
a-Cleaning The Condenser	Page 4	q-Setting The Audible Alarm Style	Page 17
b-Hinge Replacement	Page 4	r-Viewing Sensor Temperatures	Page 18
c-Replacing The Gaskets	Page 4	VIII. TROUBLE SHOOTING GUIDE	Page 19
d-Cleaning The Exterior	Page 4	IX. WARRANTY INFORMATION	Page 20
e-Cleaning The Interior	Page 4	X. OTHER	
VI. MISC. OPERATIONS		a-Service Information	Page 21
a-Adjusting The Shelves	Page 4/5	b-Spare Parts	Page 21
b-Re-Hinging The Door(s)	Page 5	c-Warranty Registration	Page 21
c-Removing The Drawers	Page 5	XI. PARTS LIST	Page 21
d-Removing The Powerpack	Page 5/6	XII. INDEX	Page 22



FORT WORTH, TX.

SERIAL VOLTS	MODEL Hz	PH	
TOTAL CURRENT	AMPS		
MINIMUM CIRCUIT	AMPS		
MAXIMUM OVERCURRENT PROTECTION			AMPS
LIGHTS	WATTS		
HEATERS	AMPS		
REFRIGERANT DESIGN PRESSURE		TYPE HIGH	OZ LOW
REFRIGERANT DESIGN PRESSURE		TYPE HIGH	OZ LOW

370-60294-00 REV (A)



I. THE SERIAL TAG

The serial tag is a permanently affixed sticker on which is recorded vital electrical and refrigeration data about your Traulsen product, as well as the model and serial number. This tag is located in the right interior compartment on all full size undercounter and equipment stand models.

READING THE SERIAL TAG

- Serial = The permanent ID# of your Traulsen
- Model = The model # of your Traulsen
- Volts = Voltage
- Hz = Cycle
- PH = Phase
- Total Current = Maximum amp draw
- Minimum Circuit = Minimum circuit ampacity
- Lights = Light wattage
- Heaters = Heater amperage (Hot Food units only)
- Refrigerant = Refrigerant type used
- Design Pressure = High & low side operating pressures and refrigerant charge
- Agency Labels = Designates agency listings

II. RECEIPT INSPECTION

All Traulsen products are factory tested for performance and are free from defects when shipped. The utmost care has been taken in crating this product to protect against damage in transit. All interior fittings have been carefully secured and the legs or casters are boxed and strapped inside to prevent damage.

You should carefully inspect your Traulsen unit for damage during delivery. If damage is detected, you should save all the crating materials and make note on the carrier's Bill Of Lading describing this. A freight claim should be filed immediately. If damage is subsequently noted during or immediately after installation, contact the respective carrier and file a freight claim. Under no condition may a damaged unit be returned to Traulsen & Co. without first obtaining written permission (return authorization).

III. INSTALLATION

III. a - LOCATION:

Select a proper location for your Traulsen unit, away from extreme heat or cold. Allow enough clearance between the unit and the side wall in order to make use of the door stay open feature at 120° (self-closing feature operates up to 90°). The door(s) must be able to open a minimum of 90° in order to make use of the maximum clear door width.

III. b - PACKAGING:

All Traulsen units are shipped from the factory bolted to a sturdy wooden pallet and packaged in a durable cardboard container. The carton is attached to the wooden skid with the use of large staples. These should first be removed to avoid scratching the unit when lifting off the crate.

Most exterior stainless steel surfaces have a protective vinyl covering to prevent scratching during manufacturing, shipping and installation. After the unit is installed in place of service, remove and discard the covering from all surfaces.

To remove the wooden pallet, first if at all possible, we suggest that the cabinet remain bolted to the pallet during all transportation to the point of final installation. The bolts can then be removed with a 3/4" socket wrench. Avoid laying the unit on its front, side or back for removal of the pallet.

NOTE: Traulsen does not recommend laying the unit down on its front, side or back. However, if you must please be certain to allow the unit to remain in an upright position afterwards for 24 hours before plugging it in so that the compressor oils and refrigerant may settle.

III. INSTALLATION (continued)

III. c - INSTALLING LEGS OR CASTERS:

6" high stainless steel legs are supplied standard for all Traulsen undercounter units. Casters in lieu of legs are available as an optional accessory for the same models. These are shipped from the factory packed inside two cardboard boxes which are strapped to one of the shelves. Remove the nylon straps and open the boxes, each should contain either four (4) legs or four (4) casters and sixteen (16) bolts (see figure 1 for proper locations).

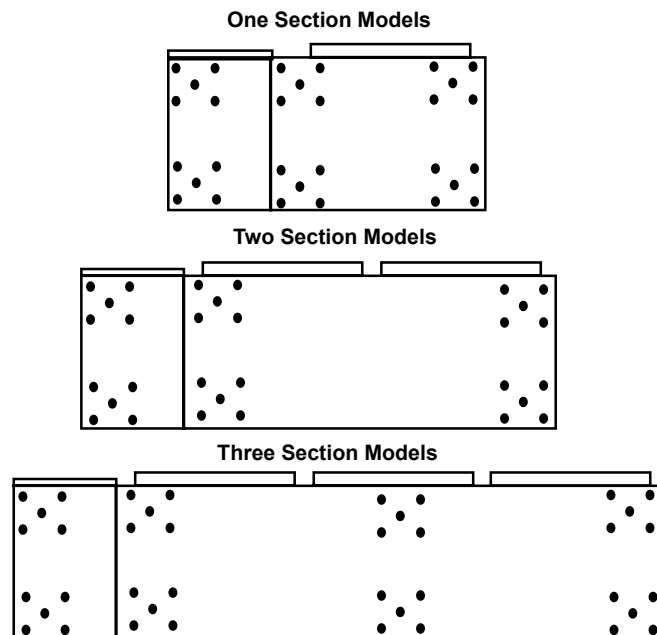

Fig. 1
Proper Leg/Caster Locations

WARNING: THE CABINET MUST BE BLOCKED AND STABLE BEFORE INSTALLING LEGS OR CASTERS.

To install the legs or casters, first raise and block the reach-in a minimum of 7" from the floor. For installing legs, thread the legs into the threaded holes on the bottom of the cabinet (see figure 2). Be certain that all legs are tightly secured (legs and casters should be tightened to 300 inch/pounds, max). When the unit is set in its final position, it is important for proper operation that the unit be level. The legs are adjustable for this purpose, turn the bottom of the leg counter-clockwise to raise it, clockwise to lower it. Level the unit from front to back as well as side to side in this manner, using a level placed in the bottom of the cabinet.

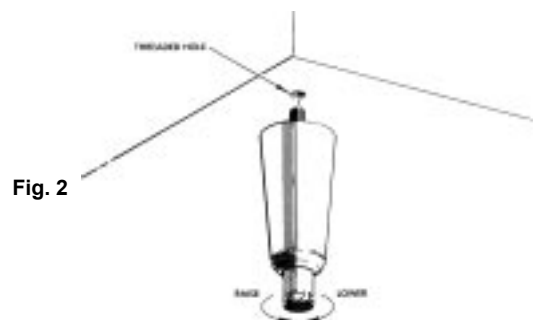

Fig. 2

III. INSTALLATION (continued)

III. d - INSTALLING LEGS OR CASTERS (cont'd):

Please note that Traulsen units are not designed to be moved while on legs. If the unit requires moving, a pallet jack or forklift should be used to prevent damage. For installing casters, the casters are "plate" type, and require the use of four (4) bolts each to secure them firmly to the cabinet bottom at each corner (see figure 3). The caster bolts are tightened using a 1/2" socket wrench.

Fig. 3



III. e - SHELF PINS:

The unit ships with shelves and shelf pins installed. Check all shelf pins to assure they are tightened down as they may have come loose during shipping. Rotate the pins clockwise until they are secured against the side of the cabinet.

III. f - CORD & PLUG:

Most self-contained models are supplied with a cord & plug attached. It is shipped coiled at the rear of the cabinet, secured by a nylon strip. For your safety and protection, all units supplied with a cord and plug include a special three-prong grounding plug on the service cord. Select only a dedicated electrical outlet with grounding plug for power source. **NOTE:** Do not under any circumstances, cut or remove the round grounding prong from the plug, or use an extension cord.

III. g - POWER SUPPLY:

The supply voltage should be checked prior to connection to be certain that proper voltage for the cabinet wiring is available (refer to the serial tag to determine correct unit voltage). Make connections in accordance with local electrical codes. Use qualified electricians.

Use of a separate, dedicated circuit is required. Size wiring to handle indicated load and provide necessary overcurrent protector in circuit (see amperage requirements on the unit's serial tag).

III. h - WIRING DIAGRAM:

Refer to the wiring diagram for any service work performed on the unit. Should you require one, please contact Traulsen Service at (800) 825-8220, and provide the model and serial number of the unit involved.

III. i - PLACING EQUIPMENT ON TOP OF UNIT:

Equipment may be placed on top of your Traulsen full-size undercounter or equipment stand. However, please be aware that a stainless steel worktop is required on cabinets being used to support equipment weighing in excess of 100 lbs. or producing heat in excess of 140°F to the top surface. Optional stainless steel tops are available from Traulsen.

IV. OPERATION

IV. a - REFRIGERATORS:

Both refrigerators and freezers do not require manual defrosting. During normal operation, a refrigerator continuously circulates above freezing cabinet air through the coil. A compressor "OFF" cycle occurs every hour to melt any frost which may accumulate on the coil during the compressor "ON" cycle. The control will read "dEF" when this occurs (see figure 4). With standard holding refrigerators, high relative humidity is also maintained to prevent dehydration of stored product.



Fig. 4

IV. b - FREEZERS:

During normal operation, a freezer continuously circulates below freezing cabinet air through the coil. The coil requires a periodic defrosting for proper operation. This is accomplished by an automatic, time activated, temperature/time terminated, defrost program, utilizing hot gas from the refrigeration system. The controller is preset at the factory for six equally spaced defrost cycles within each 24-hour period.

At the start of a freezer defrost cycle, both the compressor and evaporator fans are OFF. The INTELA-TRAUL control will read "dEF" (see figure 4). When a temperature device affixed to the coil senses 70°F, the coil is fully defrosted and the compressor operation is resumed. The coil fans are delayed from starting at the termination of a defrost cycle. Fan operation is automatically resumed, they can also be started by a time or temp delay (whichever comes first). In case of temp delay, it uses the same coil sensor and starts at 32°F. The total refrigeration system operation is then resumed.

During freezer defrost operation, heat is confined to the coil enclosure to prevent any significant rise in temperature within the food zone. The fan delay con

IV. OPERATION (continued)

IV. b - FREEZERS (cont'd):

trols function upon termination of a defrost cycle is two-fold. First, to prevent blowing warm air into the food storage area. Second, to prevent any condensation on the defrost coil from being blown into the food storage area.

The INTELA-TRAUL control is set from the factory to terminate defrost at 20 minutes in the event of a sensor failure. This setting should never be tampered with, without first consulting the factory.

IV. c - CONDENSATE REMOVAL:

Both refrigerator and freezer units are supplied with an electric condensate evaporator for condensate removal.

V. CARE & MAINTENANCE

V. a - CLEANING THE CONDENSER:

The most important thing you can do to insure a long, reliable service life for your Traulsen is to regularly clean the condenser coil.

The condensing unit requires regularly scheduled cleaning to keep the finned condenser clean of lint and dust accumulation. The INTELA-TRAUL control will notify you through a "CLN-FIL" message when cleaning is necessary (see page 7). Keeping the condenser clean allows the cabinet to operate more efficiently and use less energy.

To clean the condenser, first disconnect electrical power to the cabinet and remove the front louver assembly. To remove this, follow the directions in section VI. d - Step #1. Once the screws are removed, the panel can be removed allowing full access to the powerpack. Vacuum or brush any dirt, lint or dust from the finned condenser coil, the compressor and other cooling system parts. If significant dirt is clogging the condenser fins, use compressed air to blow this clear.

Replace louver assembly, screws and caps.

V. b - HINGE REPLACEMENT:

Both the door and hinge can be easily removed from the cabinet. To remove the door, remove the plug at the bottom of the top hinge. Inside the hinge there is a small screw which secures the door in place. Remove this with a flat head screwdriver and the door can then be lifted off the hinge. To remove the door half of the hinge from the door, lift off the hinge cover and then remove the three Phillips head screws which secure the hinge in place on the door. To remove the cabinet half of the hinge, remove the three Phillips head screws which hold it in place. To reassemble the hinge reverse the previous procedure.

V. CARE & MAINTENANCE

V. c - REPLACING THE GASKETS:

To remove the gasket to be replaced, grasp it firmly by one corner and pull it out. Before attempting to install a new gasket, both the unit and the gasket itself must be at room temperature. Insert the four corners first by using a rubber mallet (or hammer with a block of wood). After the corners are properly inserted, work your way towards the center from both ends by gently hitting with a mallet until the gasket is completely seated in place (see figure 5 for proper gasket placement).

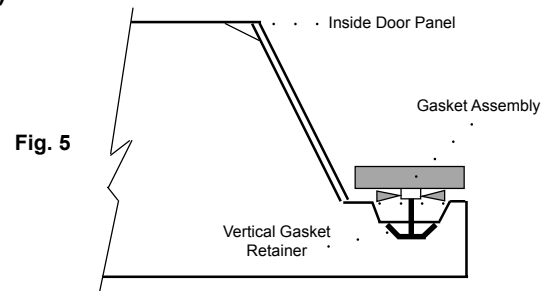

NOTE: The gasket may appear too large, but if it is installed as indicated above it will slip into place.

V. d - CLEANING THE EXTERIOR:

Exterior stainless steel should be cleaned with warm water, mild soap and a soft cloth. Apply with a dampened cloth and wipe in the direction of the metal grain.

Avoid the use of strong detergents and gritty, abrasive cleaners as they may tend to mar and scratch the surface. Do NOT use cleansers containing chlorine, this may promote corrosion of the stainless steel.

Care should also be taken to avoid splashing the unit with water, containing chlorinated cleansers, when mopping the floor around the unit.

For stubborn odor spills, use baking soda and water (mixed to a 1 TBSP baking soda to 1 pint water ratio).

V. e - CLEANING THE INTERIOR:

For cleaning both stainless steel and anodized aluminum interiors, the use of baking soda as described in section "V. d" is recommended. Use on breaker strips as well as door gaskets. All interior fittings are removable without tools to facilitate cleaning.

WARNING: DISCONNECT ELECTRICAL POWER SUPPLY BEFORE CLEANING ANY PARTS OF THE UNIT.

VI. MISC. OPERATIONS

VI. a - ADJUSTING THE SHELVES:

For shelves mounted on pins, first select the desired location and remove the white plastic covers in the interior back and sides by rotating them counter-clockwise. Remove the shelf pins by rotating them counter-clockwise. Install the pins in the desired location by

VI. MISC. OPERATIONS

VI. a - ADJUSTING THE SHELVES (cont'd):

rotating clockwise. Make sure the pin is securely tightened down. Do not over tighten. Slide the shelf into its new position, and replace the white plastic covers into the holes vacated by the shelf pins.

VI. b - REHINGING THE DOOR(S):

All UC models are supplied standard with a re-hinging feature. To begin re-hinging the door, first disconnect power to the unit.

Lift the door off its hinge cams and place aside. Next remove the plugs covering the holes of the re-hinging feature located on the side opposite of the present hinge location.

Remove the existing hinge bodies by removing the three (3) Phillips head screws which secure each to the cabinet face. Replace the hinges in their new location, and replace the screws.

Remove the hinge cover from the door half of the hinge by sliding it downwards. Next remove the hinge hardware from the door by removing the three (3) Phillips head screws which secure each to the door.

Turn the door around to its new position, and replace the hinge hardware to the door in the existing screw holes, but in the opposite position. Replace the screws to secure the hinge hardware in place.

Position the door in its new location by lowering the door hinge hardware into the hinge cams located on the cabinet face.

VI. c - REMOVING THE DRAWERS:

Each drawer on UL equipment stand models are designed to accommodate two (2) 12" x 20" x 4" deep pans, front to back. SBS models can accommodate two (2) 12" x 20" x 4" deep pans, side by side.

Drawers are supplied standard with divider bars which allow it be configured for use with half, third and quarter size pans. These are shipped along with the cabinet, taped together and secured inside of the bottom drawer. No bar is required for use with full-size pans. In all cases, pans are supplied by others.

The drawers can be easily removed by first pulling the drawer out to its full extension. Next, lift the drawer vertically to dis-engage the drawer slide wheel from the slide frame and remove the entire drawer. To replace the drawer, reverse the process.

VI. d - REMOVING & RELOCATING THE POWERPACK:

To remove the powerpack for maintenance, servicing or to relocate it to the other side, first disconnect power to the unit. If the unit is equipped with an optional stainless steel top, this will also first have to be removed. Then follow these directions:

VI. d - REMOVING THE POWERPACK:

1. Remove the louver panel by first removing the four (4) black plastic plugs that are located in each corner of the powerpack louver assembly. These conceal four (4) Phillips head screws which hold the louver in place. Remove these screws as well, and set both them and the plastic plugs aside (see figure 6).

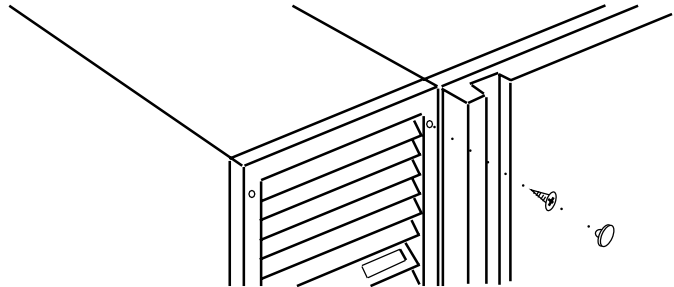

Fig. 6

2. Remove louver assembly (see Figures 7a & 7b).

3. Remove the power cord blank-off cover and retainer.

4. Disconnect power and mullion heater plugs from chassis.

5. Remove interior plenum on back wall of cabinet interior, air duct transition, supply air duct and return air grill.

6. Remove the four (4) Phillips head screws securing the powerpack to the cabinet front (see figure 8).

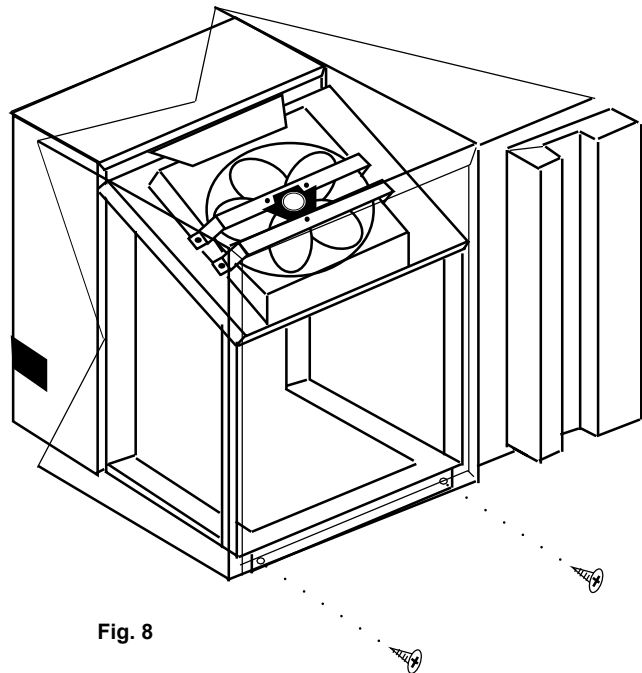

Fig. 8

7. Grasp the condenser fan mounting brace and pull the powerpack up and out gently. This allows the unit to come forward enough so as to enable the powerpack to be pulled out of the top and bottom lip brackets (see figure 9).

VI. MISC. OPERATIONS (cont'd)

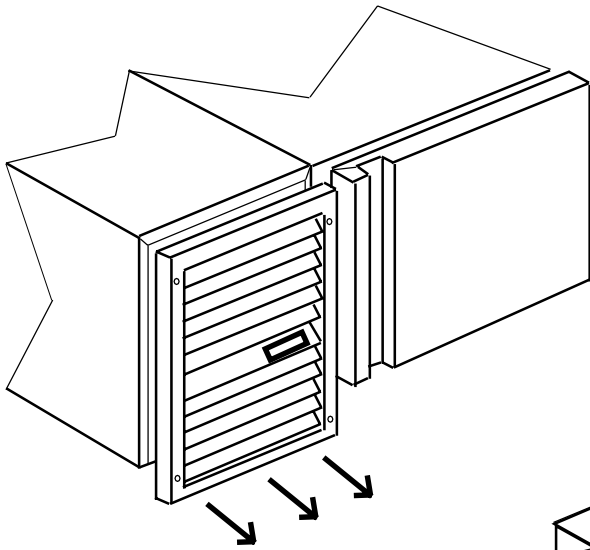

Fig. 7a
Remove Louver
Assembly

Fig. 7b

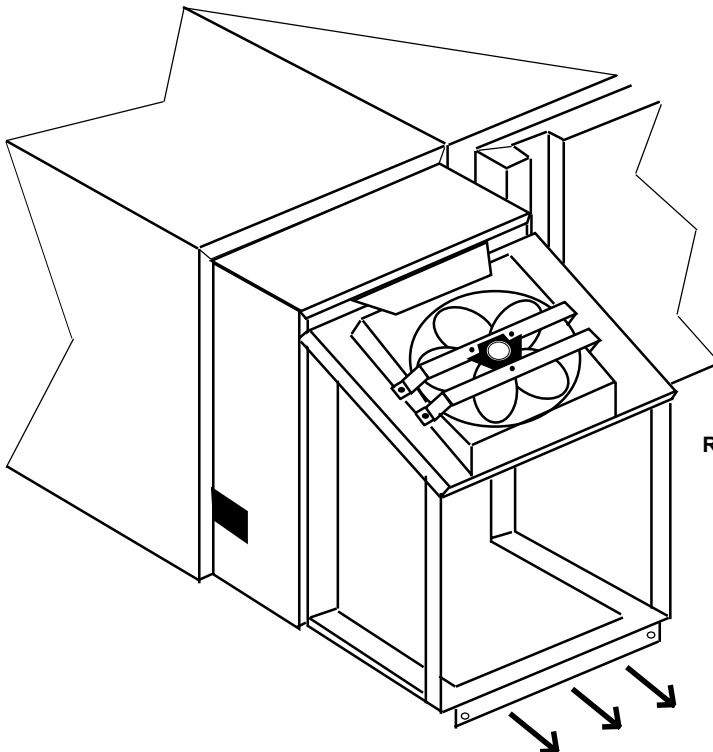
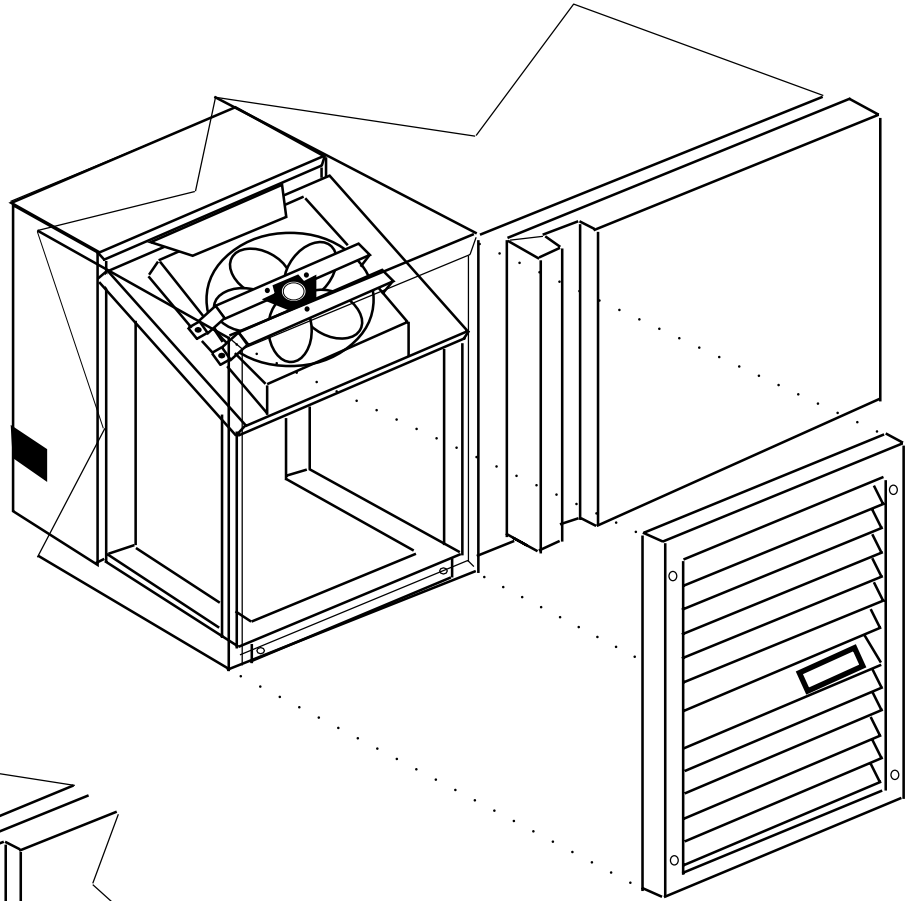

Fig. 9
Removing Power
Pack

VII. INTELA-TRAUL®

Your new Traulsen Undercounter Refrigerator or Freezer is equipped with a state-of-the-art electronic microprocessor INTELA-TRAUL® control, which precisely regulates operation and provides alarms when problems occur. It is supplied from the factory completely ready for use but without the audible alarms activated. See pages 8 thru 17 for more information.

VII. a - INTELA-TRAUL® CONTROL FEATURES:

Internal Time Clock

- Eliminates defrost time clock.
- Will display only at "Start Up".
- Must be reset after a power failure.
- See "**Setting The 24-Hour Clock**" on Page 12 (Also required at "Start Up").
- Will automatically update for Daylight Savings Time. See "**Setting Daylight Savings Time**" on page 13.

Water Resistant Housing

The INTELA-TRAUL® control is water resistant not only from the face of the control, but also from the rear of the housing.

Parameter/Service Levels

- See "**Customer / Service Parameters**" on Page 9.

Defrost Lockouts - See "Setting Defrost Lockouts" on page 15.

- Customers can set up to 4 different defrost lockout periods. The lockout prevents the unit from going into a defrost cycle during peak kitchen use. **Note: The 24-hour clock must be set for this feature to operate correctly.**

Data Storage

The control comes equipped with 72 hours worth of data storage capability including:

- Records cabinet air temperatures every 6 minutes, needed to document "**Due Diligence**" in accordance with HACCP standards.
- Records alarm events.
- Records diagnostic test of each sensor every 24 hours.
- Records failed security attempts.
- Records door open cycles.
- Records defrost cycles (refrigerator and freezer models only).

Note: The 24-hour clock and the date must be set for the above information to be recorded at the correct time and date.

Communication Ability

An RS485 port is available as a means of retrieving information from the stored data.

Smart Recovery

In the event that a sensor fails, the INTELA-TRAUL® control will maintain the same compressor operation & defrost cycles that it recorded over the previous 72 hours in order to maintain the operation of the unit until service arrives.

Alarms (See the following pages for explanations)

- High Cabinet Air Temperature
- Low Cabinet Air Temperature
- Loss Of Power
- CONDENSERCLEAN*
- Sensor Failures

* Not Available On Remote Models

VII. INTELA-TRAUL® (continued)

VII. b - ALARM EXPLANATIONS:

*NOTE: Explanation of alarms assume the audible alarm style is set at a 3-second burst or a continuous audible alarm. References to the audible alarm do not apply if the audible alarm style is set to OFF (Refer to page 17 for setting the audible alarm style).

The display shows the text "HI CAB" in a segmented font, with "HI" on the left and "CAB" on the right.

High Cabinet Air Temperature: The audible alarm* will sound and the display will read HI CAB when the temperature inside the cabinet rises above a pre-programmed limit. The limit is determined by the type of unit being operated (i.e.: refrigerator/freezer). To turn off the audible alarm*, press the alarm cancel button. The visual alarm text will continue to display until the cabinet air temperature falls below the limit. If the temperature does not fall below the limit within 5 minutes, the audible alarm* will sound again and an additional Call Service message will display.

POSSIBLE CAUSES:

- Doors open for extended periods of time.
- Large amounts of hot product placed inside the cabinet.
- Condenser coil dirty.

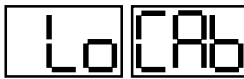
The display shows the text "Lo CAB" in a segmented font, with "Lo" on the left and "CAB" on the right.

Low Cabinet Air Temperature: The audible alarm* will sound and the display will read Lo Cab when the temperature inside the cabinet falls below a pre-programmed limit. The limit is determined by the type of unit being operated (i.e.: refrigerator/ freezer). To turn off the audible alarm*, press the alarm cancel button. The visual alarm text will continue to display until the cabinet air temperature rises above the limit. If the temperature does not rise above the limit within 5 minutes, the audible alarm* will sound again and an additional Call Service message will display.

POSSIBLE CAUSES:

- No product in unit.
- Failed sensors.

The display shows the text "ELE LOS" in a segmented font, with "ELE" on the left and "LOS" on the right.

Loss Of Power: The audible alarm* will sound and the display will read Electrical Loss, when the unit regains power after an outage. To turn off the audible alarm* and/or clear the visual text, press the alarm cancel button. You must reset the clock and date if you are using any defrost lockouts or are retrieving the information from the data storage memory. See "Setting The 24-Hour Clock" page 12 and "Setting the Date" page 13.

The display shows the text "CAL SER" in a segmented font, with "CAL" on the left and "SER" on the right.

System Leak: The audible alarm* will sound and the display will read Call Service, when the control detects a leak in the refrigeration system. To turn off the audible alarm*, press the alarm cancel button. The visual alarm text will remain until a service technician has repaired the unit. If the condition remains for 24 hours, the audible alarm* will sound again.

POSSIBLE CAUSES:

- Low refrigerant charge.
- Discharge sensor has failed low.

The display shows the text "CLn FIL" in a segmented font, with "CLn" on the left and "FIL" on the right.

CONDENSERCLEAN: The audible alarm* will sound and the display will read Clean Filter, when the operating pressures and temperatures exceed a safe operating range. As the load on the condenser decreases, the alarm will turn off by itself. As the pressures on the condenser continues to rise, the audible alarm* will stay on for longer periods of time. To turn off the audible alarm*, press the alarm cancel button. The visual alarm text will remain until the filter/condenser has been cleaned. If the condition remains for 24-hours, the audible alarm* will sound again and visual display will read Call Service.

POSSIBLE CAUSES:

- Inadequate air flow through condenser unit.
- Discharge sensor has failed high.

The display shows the text "Snr FAL" in a segmented font, with "Snr" on the left and "FAL" on the right.

Sensor Failures: The audible alarm* will sound and the display will read Sensor Failure Call Service, when any of the unit sensors fail to operate. To turn off the audible alarm*, press the alarm cancel button. The visual alarm text will remain until the sensor has been replaced. Depending on the function of the sensor, the audible alarm* will sound again in either 5 minutes or 24 hours.

The display shows the text "CAL SER" in a segmented font, with "CAL" on the left and "SER" on the right.

*Not available on remote models.

VII. INTELA-TRAUL® (continued)

VII. c - CONTROL PANEL:

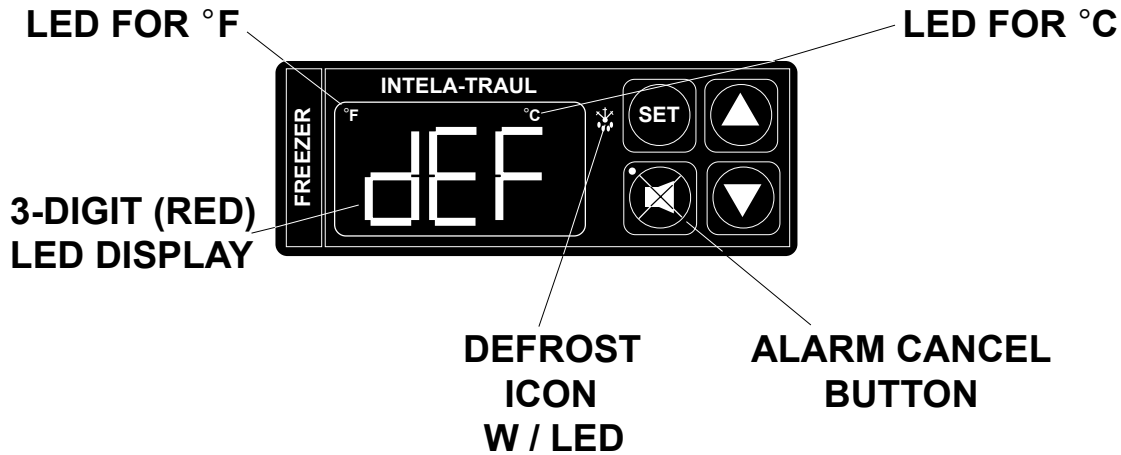

VII. d - PARTS ASSEMBLY: (UC/UL Cabinets)

COIL SENSOR*
337-60071-00
(refrigerator & freezer only)



DISCHARGE SENSOR*
337-60072-00
(refrigerator & freezer only)

CABINET SENSOR*
337-60069-00



HORN*
337-60070-00

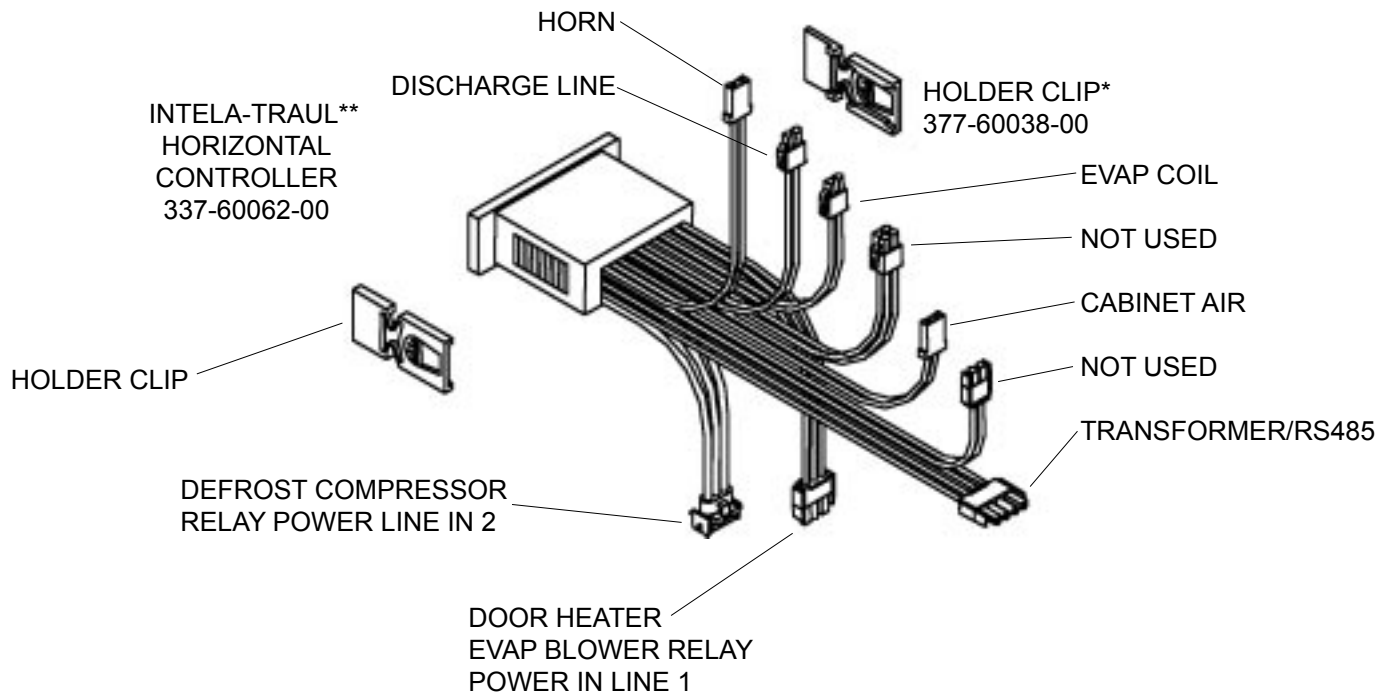

*= Can be ordered separately

**=Requires unit Model No. & S/N to place order.



VII. INTELA-TRAUL® (continued)

VII. e - NOTES TO THE USER:

You only have 20-30 seconds between button pushes. If you take longer than 30 seconds, the controller will revert back to displaying the cabinet temperature. If you enter the wrong security code, the controller will revert back to displaying the cabinet temperature. You can exit the parameters at any time by pressing the alarm cancel button or by waiting 20-30 seconds.

VII. f - ENTER THE CUSTOMER ACCESS:

Use the security code 0, A, 1  and the following instructions:

Press the set button  . The display will read  Customer/Service Access.

Press the set button  .

The display will show three zeros with the left zero flashing 
↑

Press the set button  .

The display will show three zeros with the center zero flashing 
↑

Press the down arrow key  to sequence through F, E, d, C, b, A, 9, 8, 7,...etc.

When you reach A press set  .

The display will show zero, A, zero with the right zero flashing 
↑

Press the up arrow key  to sequence through 1, 2, 3, 4, 5, 6, 7, 8, 9, A, b,...etc.

When you reach 1 press set  .

















The display will read  Thermostat Set Point High.

You are now in the **CUSTOMER / SERVICE PARAMETERS.**

VII. INTELA-TRAUL® (continued)

VII. g - CUSTOMER SERVICE PARAMETERS:

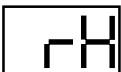
Listed below are the available parameters in the order they appear, using the down arrow key on the controller. You can use either the up or down arrow keys to scroll through the options.



 Thermostat Set Point High	 Defrost Lockout 2
 Thermostat Set Point Low	 Defrost Lockout 3
 Temperature Scale	 Defrost Lockout 4
 Audible Alarm Style	 Room Temperature Offset
 Time (24-hour clock)	 Ambient Air Sensor
 Date (month - day - year)	 Evaporator Coil Sensor
 Daylight Savings	 Discharge Line Sensor
 Start Manual Defrost	 Relative Humidity Sensor
 Defrost Lockout 1	

VII. h - ADJUSTING THE THERMOSTAT SET POINT HIGH:

This parameter sets the high point of the desired cabinet temperature range. Typically, freezers will range from -3° F to 0° F (-19° C to -18° C) and refrigerators will range from 36° F to 40° F (2° C to 4° C) for this parameter setting. This parameter is preset at the factory and does not have to be adjusted unless the customer chooses to do so. Note: Set Point Low and Set Point High **cannot** be set to the same temperature. There will be at least 1-2 degree difference between the two settings.



Follow the instructions to enter the customer access code on page 9. When the control

display reads  Thermostat Set Point High. Press the set button .

Use the arrow keys   to adjust the temperature to your desired setting.

When the display shows the temperature you want press the set button .

The display will then read  Thermostat Set Point High.

You can use the up or down arrow keys  





or press the alarm cancel button to exit .



VII. INTELA-TRAUL® (continued)

VII. i - ADJUSTING THE THERMOSTAT SET POINT LOW:

This parameter sets the low point of the desired cabinet temperature range. Typically, freezers will range from -6°F to -4°F (-21°C to -20°C) and refrigerators will range from 32°F to 34°F (0°C to 1°C) for this parameter setting. This parameter is preset at the factory and does not have to be adjusted unless the customer chooses to do so. Note: Set Point Low and Set Point High **cannot** be set to the same temperature. There will be at least 1-2 degree difference between the two settings.



Follow the instructions to enter the customer access code on page 9. When the control

displays  Thermostat Set High, press the down arrow key  until the control display reads  Thermostat Set Point Low. Press the set button .

Use the arrow keys   to adjust the temperature to your desired setting.

When the display shows the temperature you want press the set button .





The display will then read  Thermostat Set Point High.





You can use the up or down arrow keys to scroll to the next parameter   or press the alarm cancel button to exit .

VII. j - Changing The Temperature Scale:

The temperature scale determines if the temperature displayed will be in degrees Fahrenheit or degrees Celsius.

Follow the instructions to enter the customer access code on page 9. When the control

displays  Thermostat Set High, press the down arrow key  until the control display reads  Temperature Scale. Press the set button .

The display will start with the current setting either  for degrees Fahrenheit or  for degrees Celsius. Use the arrow keys   to toggle between the options.

When the display shows the scale you want press the set button .

The display will then read  Thermostat Set Point High.

You can use the up or down arrow keys   to scroll to the next parameter or press the alarm cancel button to exit .



VII. INTELA-TRAUL® (continued)



VII. k - SETTING THE 24-HOUR CLOCK:

The internal timeclock must be set in order for the data storage memory to correctly log events and to allow any defrost lockout to occur at the correct time of day. If the clock is not set, the control assumes the time is 12 am at the time power is supplied to the unit. The hours on a 24-hour time clock read the following way:

H01 = 1:00 a.m.	H07 = 7:00 a.m.	H13 = 1:00 p.m.	H19 = 7:00 p.m.
H02 = 2:00 a.m.	H08 = 8:00 a.m.	H14 = 2:00 p.m.	H20 = 8:00 p.m.
H03 = 3:00 a.m.	H09 = 9:00 a.m.	H15 = 3:00 p.m.	H21 = 9:00 p.m.
H04 = 4:00 a.m.	H10 = 10:00 a.m.	H16 = 4:00 p.m.	H22 = 10:00 p.m.
H05 = 5:00 a.m.	H11 = 11:00 a.m.	H17 = 5:00 p.m.	H23 = 11:00 p.m.
H06 = 6:00 a.m.	H12 = 12:00 p.m.	H18 = 6:00 p.m.	H24 = 12:00 a.m.

Follow the instructions to enter the customer access code on page 9. When the control

displays  Thermostat Set High, press the down arrow key  until the control



display reads  Clock. Press the set button .

The display will show  Hours. The right two numbers will be flashing.

Use the arrow keys   to set the hour.

When the correct hour is displayed, press the set button .

The display will show  Minutes. The right two numbers will be flashing.

Use the arrow keys to set the minutes  .

When the correct minutes are displayed, press the set button .





















The display will then read  Thermostat Set Point High.

You can use the up or down arrow keys   to scroll to the next parameter













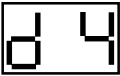

or press the alarm cancel button to exit .

VII. INTELA-TRAUL® (continued)

VII. I - SETTING THE DATE:

The date must be set in order for the data storage memory to correctly log events. Follow the instructions to enter the customer access code on page 9. When the control displays  Thermostat Set Point High, press the down arrow key  until the control display reads  Date. Press the set button . The display will show  (year). The right two numbers will be flashing. Press the arrow keys   to set the year. When the correct year is displayed, press the set button . The display will show  (month). The right two numbers will be flashing. Use the arrow keys   to set the month. When the correct month is displayed, press the set button . The display will show  (day). The right two numbers will be flashing. Press the arrow keys   to set the day. When the correct day is displayed, press the set button . The display will then read  Thermostat Set Point High. You can use the up or down arrow keys   to scroll to the next parameter, press the alarm cancel button to exit .

VII. m - SETTING DAYLIGHT SAVINGS TIME:



This parameter is preset at the factory to automatically adjust the 24-hour clock for Daylight Savings Time. Follow the instructions to enter the customer access code on page 9. When the control displays  Thermostat Set Point High, press the down arrow key  until the display reads  Daylight Savings Time. Press the set button . The display will show  Daylight Savings Time (Yes, automatically adjust for Daylight Savings Time). For "YES" press the set button , for "NO" press the up or down arrow key  . The display will read  Daylight Savings Time (no). Press the set button . The display will read  Thermostat Set Point High. You can press the the up or down arrow keys   to scroll to the next parameter or press the alarm cancel button to exit .

VII. INTELA-TRAUL® (continued)

VII. n - STARTING A MANUAL DEFROST CYCLE:

This parameter allows a service technician to start a defrost cycle at any time. This parameter will override any lockout settings.

Follow the instructions to enter the customer access code on page 9. When the control

displays  Thermostat Set High, press the down arrow key  until the control

display reads  Start Manual Defrost.

Press the set button  .

The display will show  (NO).

Press either arrow key   (YES).

The display will show  .

Press the set button  .

The display will then read  Thermostat Set Point High.

You can use the up or down arrow keys   to scroll to the next parameter

or press the alarm cancel button to exit  .

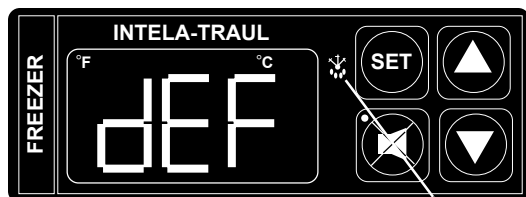

The defrost icon will be lit,

and the display will read

 when the unit is in defrost.

DEFROST ICON

NOTE: Traulsen refrigerator units also have an off-cycle defrost once an hour, at which time the control will read  . This defrost is temperature terminated and can last from 3 - 10 minutes (dEF will be displayed for 22-27 minutes time).

VII. INTELA-TRAUL® (continued)

VII. o - SETTING THE DEFROST LOCKOUTS:

The defrost lockout parameters allow the customer to prevent the unit from going into a defrost cycle for two hours during a set timeframe. Customers can set up to four defrost lockout parameters. They are all programmed the same way. The parameters will be set for the time the lockout is to start. The controller automatically calculates 2 hours from that setting. The options are similar to the 24-hour clock settings and are in 30-minute increments. Each of the lockout parameters covers 6 hours of the 24-hour clock. Note: The 24-hour clock must be set for this feature to operate at the correct time of day. See “**Setting the 24-Hour Clock**” on page 12.

Sample:

OFF

020 = 2:00 a.m.

023 = 2:30 a.m.

030 = 3:00 a.m.

033 = 3:30 a.m.

040 = 4:00 a.m.

043 = 4:30 a.m.

050 = 5:00 a.m.

053 = 5:30 a.m.

060 = 6:00 a.m.

063 = 6:30 a.m.

070 = 7:00 a.m.

073 = 7:30 a.m.

080 = 8:00 a.m.

OFF

080 = 8:00 a.m.

083 = 8:30 a.m.

090 = 9:00 a.m.

093 = 9:30 a.m.

100 = 10:00 a.m.

103 = 10:30 a.m.

110 = 11:00 a.m.

113 = 11:30 a.m.

120 = 12:00 p.m.

123 = 12:30 p.m.

130 = 1:00 p.m.

133 = 1:30 p.m.

140 = 2:00 p.m.

OFF

140 = 2:00 p.m.

143 = 2:30 p.m.

150 = 3:00 p.m.

153 = 3:30 p.m.

160 = 4:00 p.m.

163 = 4:30 p.m.

170 = 5:00 p.m.

173 = 5:30 p.m.

180 = 6:00 p.m.

183 = 6:30 p.m.

190 = 7:00 p.m.

193 = 7:30 p.m.

200 = 8:00 p.m.

OFF

200 = 8:00 p.m.

203 = 8:30 p.m.

210 = 9:00 p.m.

213 = 9:30 p.m.

220 = 10:00 p.m.

223 = 10:30 p.m.

230 = 11:00 p.m.

233 = 11:30 p.m.

240* = 12:00 a.m.

243* = 12:30 a.m.

010 = 1:00 a.m.

013 = 1:30 a.m.

020 = 2:00 a.m.

* Denotes not available.

A lockout can not be programmed to start at 12:00 am or 12:30 am due to conflicts with other internal programs. The defrost lockouts can not be programmed to run back-to-back. For example, if dL1 is set to 080, then a defrost cycle would be locked out from 8:00 am to 10:00 am. Because of the dL1 setting the dL2 parameter would not let the user choose a lockout start time before 10:30 am. All lockouts are preset at the factory to OFF.

Follow the instructions to enter the customer access code on page 9. When the control

displays Thermostat Set High, press the down arrow key until the control the

control display reads or . Press the set button .

The display will show Off. Press the arrow keys to set the start time.

When the correct time is displayed, press the set button .

The display will then read Thermostat Set Point High.

You can press the up or down arrow keys to scroll to the next parameter

or press the alarm cancel button to exit .

VII. INTELA-TRAUL® (continued)





VII. p - ADJUSTING THE ROOM TEMPERATURE OFFSET:

The room temperature offset parameter allows a service technician or end user the ability to have the display show a temperature that is within three degrees of the actual temperature being read by the cabinet air sensor. This allows for continuity of reading between different temperature reading devices. (i.e.: thermistor Vs thermocouple Vs handheld thermometer) This parameter is preset at the factory to "0" or no offset.

Follow the instructions to enter the customer access code on page 9. When the control displays

 Thermostat Set High, press the down arrow key  until the control display reads 





Room Temperature Offset. Press the set button . Use the arrow keys   to adjust the offset to your desired setting. When the display shows the offset you want press the set button .









The display will then read  Thermostat Set Point High. You can use the up or down arrow keys   to scroll to the next parameter or press the alarm cancel button to exit .

VII. q - SETTING THE AUDIBLE ALARM STYLE:

This parameter will allow the customer to turn on/off the audible alarm feature on the INTELA-TRAUL® control. The audible alarm is preset from the factory to OFF. The customer can choose between an audible alarm that sounds for 3 seconds then automatically turns off, or a continuous audible alarm that must be manually acknowledged. Regardless of this feature's setting, visual alarm text will display when conditions warrant.

To adjust this setting, follow the instructions to enter the customer access code on page 9. When the

control displays  Thermostat Set Point High, press the up arrow key  until the display reads  Audible Alarm Style. Press the set button . The display will read  OFF.





Use the arrow keys   to scroll between  for the 3-Second Audible Alarm Burst or  for Continuous Audible Alarm. When the display shows your choice of style, press the set button . The display will then read  thermostat Set Point High. Use the arrow keys   to scroll to the next parameter or press the Alarm Cancel Button  to exit.

VII. INTELA-TRAUL® (continued)

VII. r - VIEWING SENSOR TEMPERATURES:

These parameters allow a service technician or customer to view the temperature of all sensors within the unit. The temperatures cannot be adjusted.

Follow the instructions to enter the customer access code on page 9. When the control displays

Thermostat Set Point High , press the DOWN arrow key  until the display reads
Evaporator Coil Sensor  or Discharge Line Sensor  or press the SET button .

The display will read Thermostat Set Point High .

Press the UP or DOWN arrow keys   to scroll through the parameters or press the ALARM
CANCEL button  to exit.

VIII. TROUBLE SHOOTING GUIDE

FIND YOUR PROBLEM HERE	REMEDY
1. Condensing unit fails to start.	<ul style="list-style-type: none"> a. Check if cord & plug has been disconnected. b. Check INTELA-TRAUL® temperature setting.
2. Condensing unit operates for prolonged periods or continuously.	<ul style="list-style-type: none"> a. Are doors closing properly? b. Dirty condenser or filter. Clean properly. c. Evaporator coil iced. Needs to defrost. See instructions for setting a manual defrost cycle on page 15. d. Shortage of refrigerant, call service.
3. Food compartment is too warm.	<ul style="list-style-type: none"> a. Check door(s) and gasket(s) for proper seal b. Perhaps a large quantity of warm food has recently been added or the door was kept open for a long period of time, in both cases, allow adequate time for the cabinet to recover its normal operating temperature. c. INTELA-TRAUL® setting too high, readjust per instructions on page 11.
4. Food compartment is too cold.	<ul style="list-style-type: none"> a. Perhaps a large quantity of very cold or frozen food has recently been added. Allow adequate time for the cabinet to recover its normal operating temperature. b. Adjust the INTELA-TRAUL® to a warmer setting, see page 12.
5. Condensation on the exterior surface.	<ul style="list-style-type: none"> a. Check door alignment and gaskets for proper seal. b. Condensation on the exterior surface of the unit is perfectly normal during periods of high humidity.
6. Compressor hums but does not start.	<ul style="list-style-type: none"> a. Call for service.

IX. WARRANTY INFORMATION

STANDARD DOMESTIC WARRANTY

TRAULSEN & CO., INC. warrants new equipment to the original purchaser, when installed within the United States against defective material and workmanship for one (1) year from the date of original installation. Under this warranty, TRAUlsen & CO., INC. will repair or replace, at its option, including service and labor, all parts found to be defective and subject to this warranty. The compressor part is warranted for an additional four (4) years. During this period TRAUlsen & CO., INC. will supply replacement compressor(s) if deemed defective, however, all installation, recharging and repair costs will remain the responsibility of the owner.

This warranty does not apply to damage resulting from fire, water, burglary, accident, abuse, misuse, transit, acts of God, terrorism, attempted repairs, improper installation by unauthorized persons, and will not apply to food loss.

For Traulsen units purchased with a remote feature, standard warranty will apply only to those components contained within the unit to the point of connection of the refrigeration lines leading to the remote compressor.

THERE ARE NO ORAL, STATUTORY OR IMPLIED WARRANTIES APPLICABLE TO TRAUlsen, INCLUDING BUT NOT LIMITED TO, ANY IMPLIED WARRANTY OF MERCHANTABILITY OR FITNESS FOR ANY PARTICULAR PURPOSE WHICH EXTEND BEYOND THE DESCRIPTION ON THE FACE HEREOF. TRAUlsen SHALL HAVE NO OBLIGATION OR LIABILITY FOR CONSEQUENTIAL OR SPECIAL DAMAGES, GROWING OUT OF OR WITH RESPECT TO THE EQUIPMENT OR ITS SALE, OPERATION OR USE, AND TRAUlsen NEITHER ASSUMES NOR AUTHORIZES ANYONE ELSE TO ASSUME FOR IT ANY OBLIGATION OR LIABILITY IN CONNECTION WITH THE EQUIPMENT OR ITS SALE, OPERATION OR USE OTHER THAN AS STATED HEREIN.

INTELA-TRAUL[®] CONTROL WARRANTY

TRAULSEN & CO., INC. (TRAULSEN), warrants to the original purchaser of the INTELA-TRAUL[®] control when installed as part of the Refrigeration/Hot Food Equipment manufactured and sold by TRAUlsen, to be free of defects in material and workmanship under normal service and use for a period of two (2) years from the date of installation. Under this warranty statement, TRAUlsen will repair or exchange at TRAUlsen'S discretion, F.O.B. factory, any part of said control, which proves to be defective. Inspection by the TRAUlsen Service Department of parts claimed defective shall be final in determining warranty status. The warranty is to include repair or exchange of any defective In-Warranty control or part(s) of said control for:

Part(s) – Any TRAUlsen INTELA-TRAUL[®] supplied part(s) found to be defective.

Labor – The labor charges from a TRAUlsen Certified Service Agent to effect the repair or exchange of the defective part(s).

“Defective Part Return” – All claimed defective part(s) must be returned to TRAUlsen for defect validation within 30 days from the date of the repair. Failure to return all claimed defective part(s) to TRAUlsen will invalidate the warranty claim, this warranty statement, and forfeit payment for those repairs effected.

This warranty does not apply to damage resulting from fire, water, burglary, accident, abuse, misuse, transit, acts of God, terrorism, attempted repairs, improper installation by unauthorized persons, and will not apply to food loss, and will not apply if said equipment is located outside The United States.

INTERNATIONAL COMMERCIAL WARRANTY

(for Canadian warranties see domestic US warranty)

TRAULSEN & CO., INC. warrants to the original purchaser the Refrigeration Equipment manufactured and sold by it to be free from defects in material and workmanship under normal use and service for a period of one (1) year from date of shipment. Under this warranty, TRAUlsen & CO., INC. will reimburse the purchaser for the replacement of any part of said equipment (excluding dryers & refrigerant gas) which then proves to be defective. This warranty does not apply to damage resulting from fire, water, burglary, accident, abuse, misuse, transit, acts of God, terrorism, attempted repairs, improper installation by unauthorized persons, and will not apply to food loss.

TRAULSEN'S standard warranty does not apply to Export Sales. Rather, for a period of one (1) year from date of original installation not to exceed Fifteen (15) months from date of shipment from factory, TRAUlsen:

will replace, F.O.B. factory, any defective parts normally subject to warranty.

will not cover the cost of packing, freight or labor such costs being the sole responsibility of the dealer.

THIS WARRANTY IS IN LIEU OF ALL OTHER WARRANTIES EITHER EXPRESSED OR IMPLIED AND CONSTITUTES TRAUlsen'S FULL OBLIGATION AND LIABILITY. WARRANTIES NOT AVAILABLE ON REMOTE MODELS.

X. OTHER

X. a - SERVICE INFORMATION:

Before calling for service, please check the following:

- Is the electrical cord plugged in?
- Is the fuse OK or circuit breaker on?
- Is the power switch "ON"?

If after checking the above items and the unit is still not operating properly, please contact an authorized Traulsen service agent. A complete list of authorized service agents was provided along with your Traulsen unit. If you cannot locate this, you may also obtain the name of a service agent from the Tech Service page of our website: www.traulsen.com.

If service is not satisfactory, please contact our in-house service department at:

Traulsen & Co., Inc.
4401 Blue Mound Road
Fort Worth, TX 76106
(800) 825-8220

Traulsen & Co., Inc. reserves the right to change specifications or discontinue models without notice.

X. b - SPARE PARTS:

Spare or replacement parts may be obtained through a parts supplier or one of our authorized service agents. A complete list of authorized service agents accompanies this manual and is also posted on our company's official website @ www.traulsen.com.

X. c - WARRANTY REGISTRATION:

For your convenience, the warranties on your new Traulsen unit may be registered with us by one of two methods. Completing the enclosed warranty card (shipped with the unit), or by filling out the on-line warranty registration form located on the Technical Service page of our website (www.traulsen.com).

XI. PARTS LIST

PART	PART #	DESCRIPTION
Breaker Cap, All UC Models	345-60012-00	Replacement breaker cap for all UC models
Caster, 6" High	344-13140-01	Optional caster for all reach-in models
Caster, 4" High W/O Brake	SMO-28627-00	Optional lower height caster
Caster, 4" High W/Brake	SMO-28628-00	Optional lower height caster
Caster Bolt (4 req'd per caster)	351-25542-00	Bolt for above
Door Gasket, All UC Models	341-60005-00	Replacement door gasket for UC models
Door Lock, Sliding Glass	346-60005-00	Jewelers type door lock for sliding glass door model
Drawer, UL Models		Replacement drawer for all front to back pan models
Drawer, UL Models		Replacement drawer for all side by side pan models
Duct, Transition	377-6006-00	Replacement transition duct
Duct, Return Assembly	377-60006-00	Replacement return air duct assembly
Duct, Inlet Assembly	377-60008-00	Replacement inlet duct assembly
Hinge Body, All UC Models	344-28482-00	Replacement hinge body
Hinge Bracket, All UC Models	344-28487-00	Replacement hinge bracket
Hinge Cover, All UC Models	344-28486-00	Replacement hinge cover
Leg, 4" High Adjustable	344-29558-00	Replacement or optional leg
Leg, 6" High Adjustable	344-13168-01	Replacement leg
Louver Assembly, All UC Models		Replacement louver assembly for all UC models
Louver Assembly, All UL Models		Replacement louver assembly for all UL models
Shelf Pin	344-24759-00	Replacement shelf pin
Side Panel, Exterior		Stainless steel exterior side panel

XII. INDEX

<u>A</u>		<u>R</u>	
Alarms	6	Return Authorization	2
Audible Alarm Styles	16	Room Temperature Offset	16
<u>B</u>		<u>S</u>	
<u>C</u>		Serial Tag	1
Cleaning	5	Shelf Pins	2
Casters	2	Shelves	2, 5
Condensate Evaporator	4	Smart Recovery	6
Cord & Plug	3	<u>T</u>	
Customer Access Code	9	Thermostat Set Point High	10
Customer Service Parameters	10	Thermostat Set Point Low	11
<u>D</u>		<u>U</u>	
Daylight Savings Time	13	<u>V</u>	
Defrost Lockouts	6, 15	Vinyl, Protective Covering	2
Data Storage	6	<u>W</u>	
<u>E</u>		Warranty	19
<u>F</u>		Warranty, Registration	21
<u>G</u>		Wiring Diagram	3
Gaskets	5	<u>X</u>	
<u>H</u>		<u>Y</u>	
Hinge	4, 5	<u>Z</u>	
<u>I</u>			
Internal Time Clock	6		
INTELA-TRAUL®	3, 4, 5, 6-17		
<u>J</u>			
<u>K</u>			
<u>L</u>			
Legs	2		
Louver Assembly	4, 5		
<u>M</u>			
Manual Defrost Cycle	14		
<u>N</u>			
<u>O</u>			
<u>P</u>			
Power Supply	3		

HOURS OF OPERATION:

Monday thru Friday 7:30 am - 4:30 pm CST



Quality Refrigeration

Traulsen & Co., Inc.

4401 Blue Mound Road Fort Worth, TX 76106

Phone: (800) 825-8220 Fax-Svce: (817) 740-6757

Website: www.traulsen.com