



GDM-72F

GDM-49F

GDM Freezer Parts Manual

**Includes: GDIM and
GDM (Glass Door
Merchandiser) Models**

TO PLACE AN ORDER OR OBTAIN INFORMATION:

WEB SITE:

www.truemfg.com (Visit our Parts eStore at: <http://estore.truemfg.com>)
Parts Department e-mail address: parts@truemfg.com

SEND INQUIRIES TO:

TRUE MANUFACTURING COMPANY, INC. ATTN: PARTS DEPARTMENT
St. Charles Industrial Center • P.O. Box 970 • O'Fallon, Missouri 63366 • U.S.A

CALL TOLL-FREE:

800-424-TRUE (Direct to Parts Department)
or 800-325-6152 (U.S.A & Canada only)
OR CALL: 636-240-2400

FAX: 636-272-9471

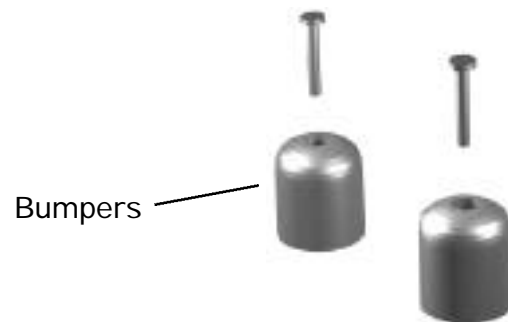

A.

Castors, Legs & Levelers

Castors



Castors
(2 1/2 wheels)



Screw, Leveling
Nylon Foot



Legs



Screw, Leveling



Seismec legs



Legs



Legs



Castors



B.

Compressors

GDM Freezer 1/2 HP or less.

Motor, Condenser Fan

Cord, Power
(Compressor)

Condensing Unit

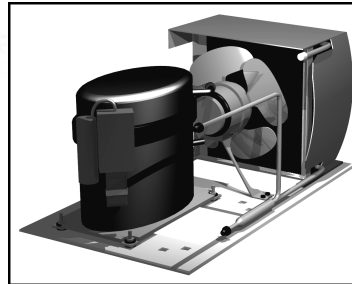

Top Mount Condensing Unit



Bracket,
Fan Motor

Blade, Fan
Motor
Condenser

Accumulator

Cord,
Power

Compressor
Valve-CRO

Outlet, Compressor

Block, Terminal

— Accumulator &
Shorter Suction Line
for Top Mount Units

Overload

Relay

Capacitor,
start

Accumulator &
Suction Line

Compressor Pull
out

Compressor

Shroud,
Condenser
Coil

Block

Coil, Condenser

Capillary
Tube

Bolt,
Compressor

Drier,
Compressor

C.

Base, Compressor

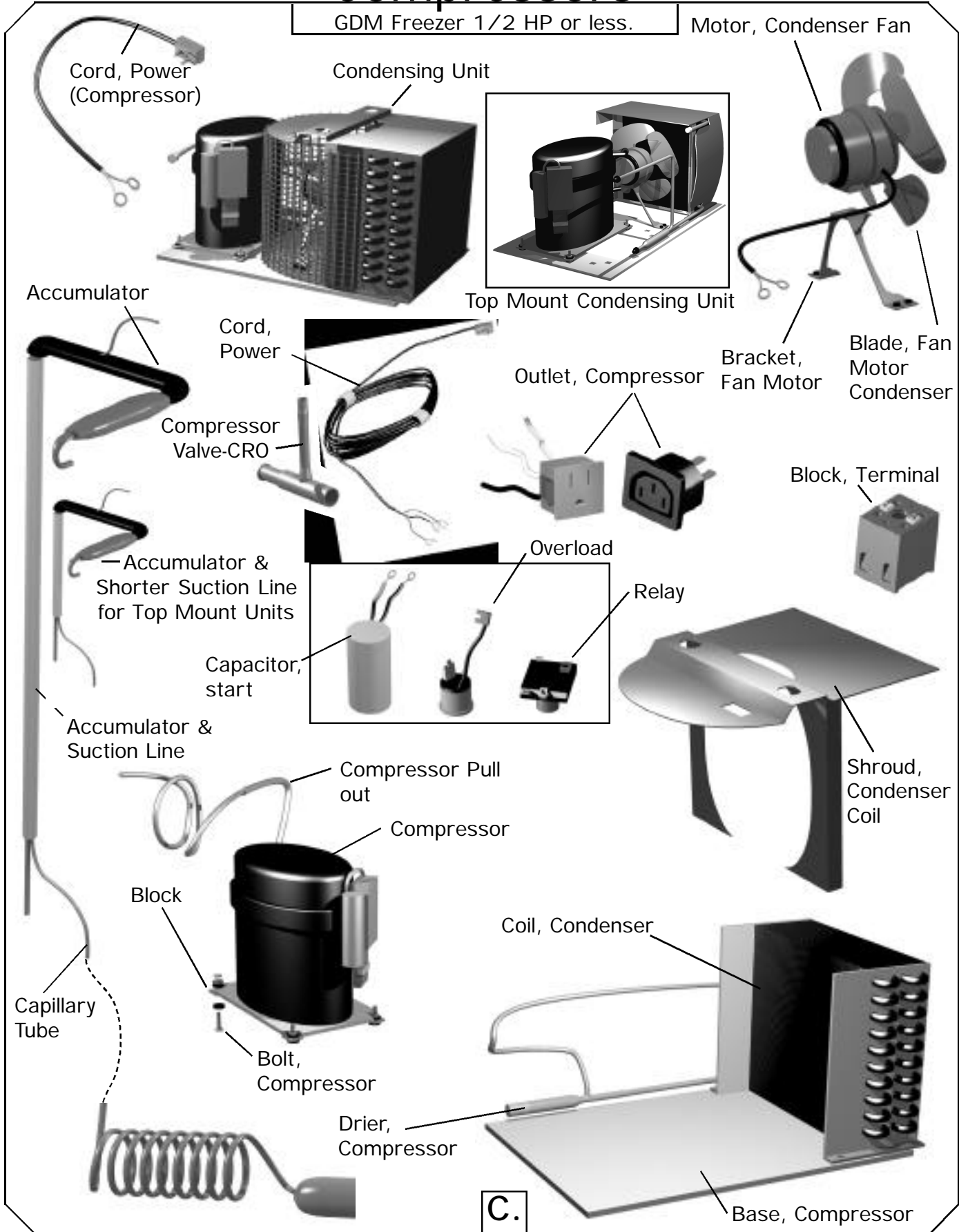

Compressors

GDM Freezer 3/4 HP and up.

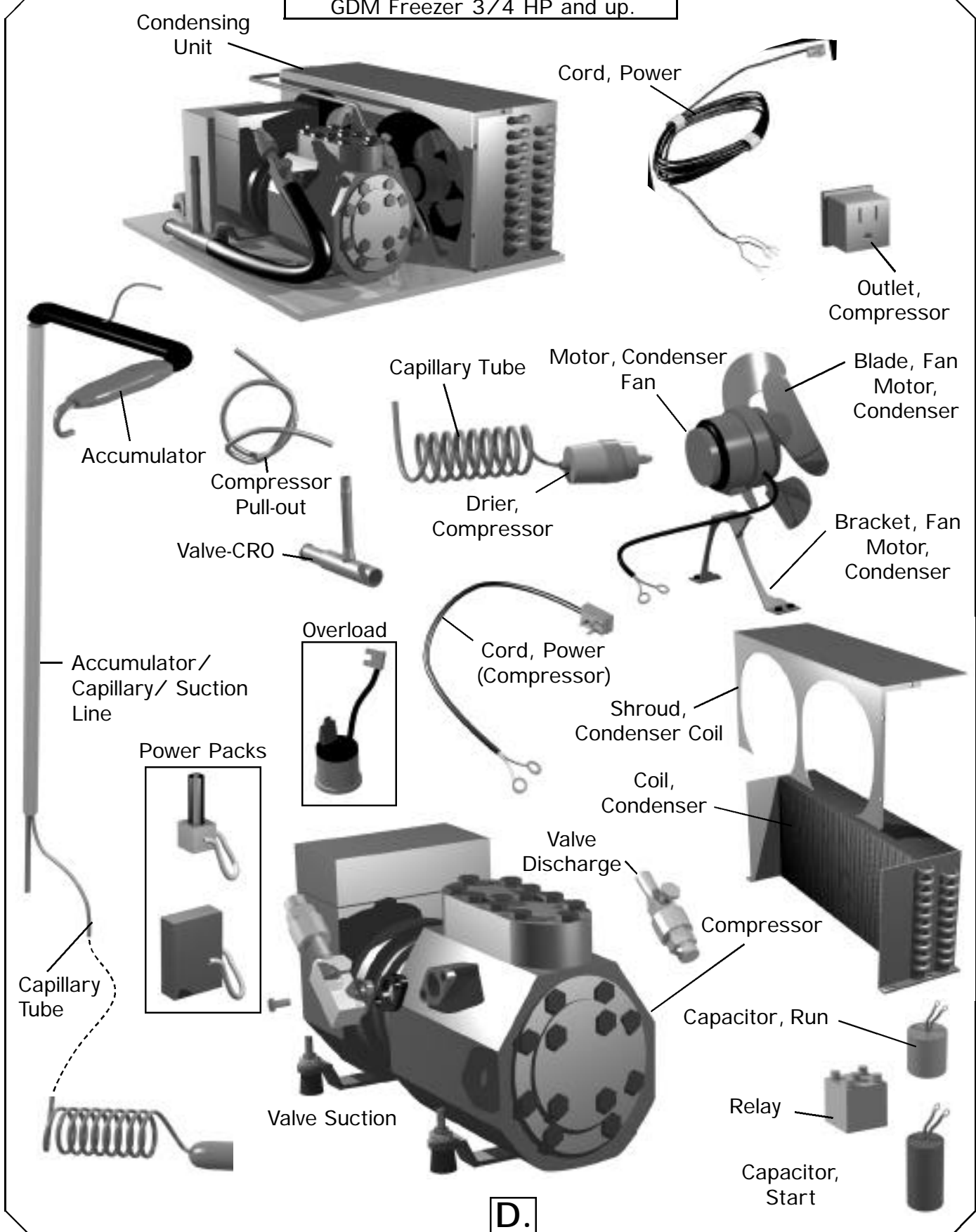

D.

Door Parts

GDM Freezer Swing Door with Integrated Door Light (IDL) VHO Lamp

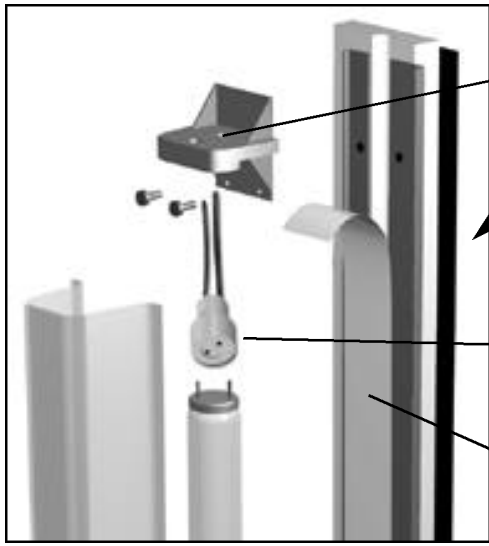

Base, Lampholder

Door

Lampholder Top
#540 with 53 3/4" lead

Tape, Light Filler
Channel Aluminum

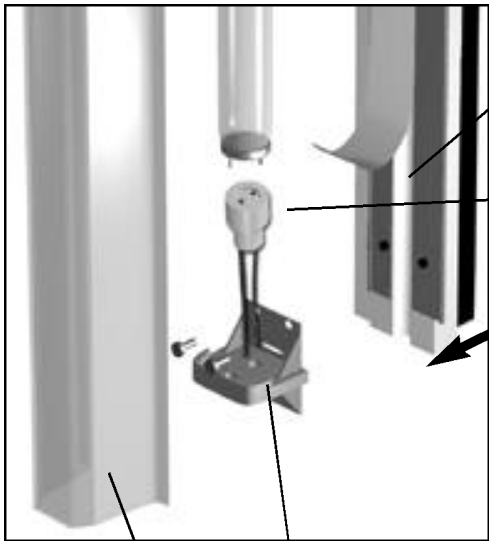

Channel, Light
Filler

Lampholder Bottom
#541 with 5 3/4" lead

Base, Lampholder

Lamp

Tape, Light
Aluminum

Frame,
Door

Lamp Shield

Bushing,
Strain
Relief

Cord, Power,
Door "Y"

Receptacle

Insert, Glass

Cord, Power

Back Plate
Door Gasket

Heater Door Frame
802235

E.

Door Parts

GDM Freezer Swing Door with Integrated Door Light (IDL) 24K

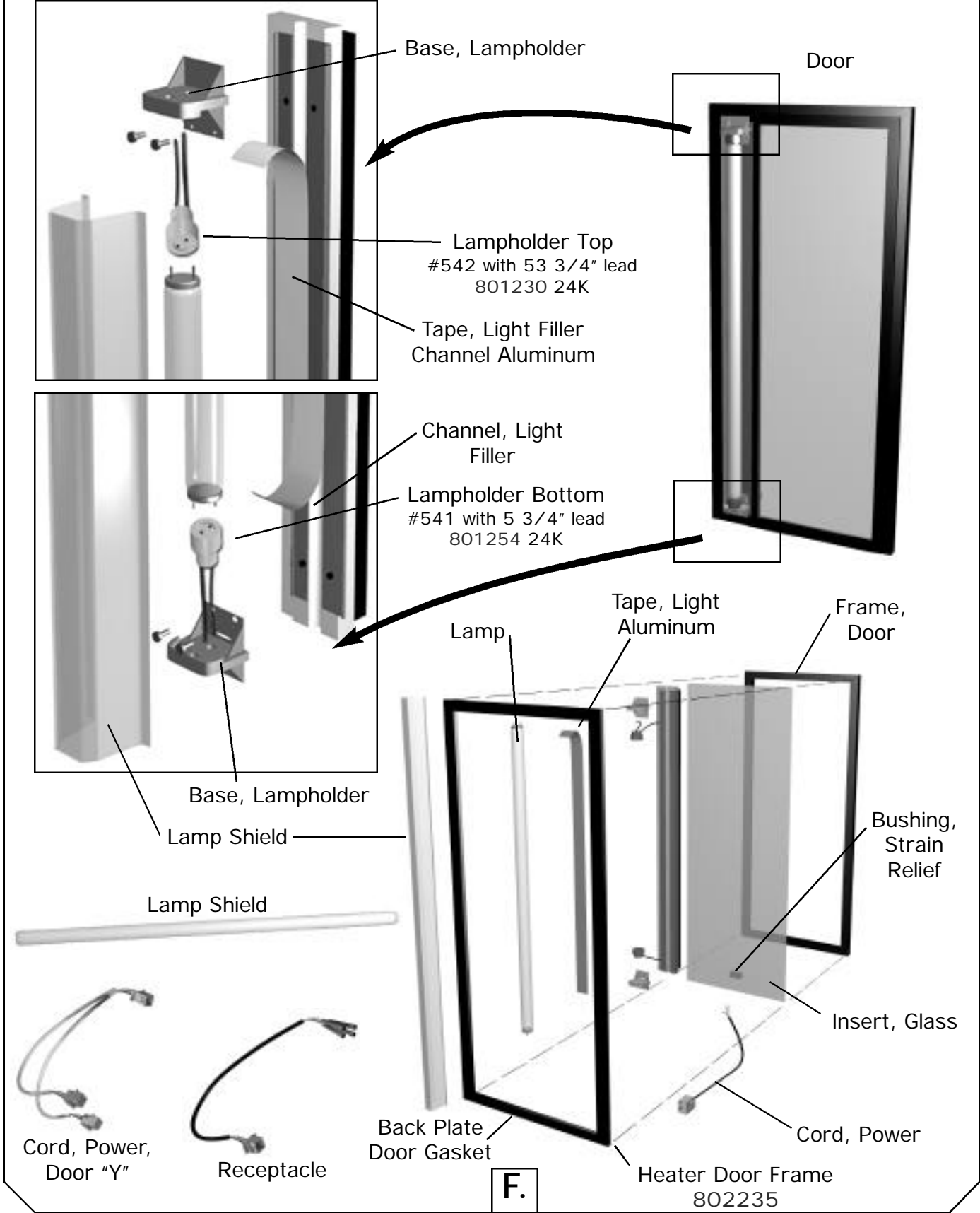

Door Parts

GDM Swing Door Non IDL

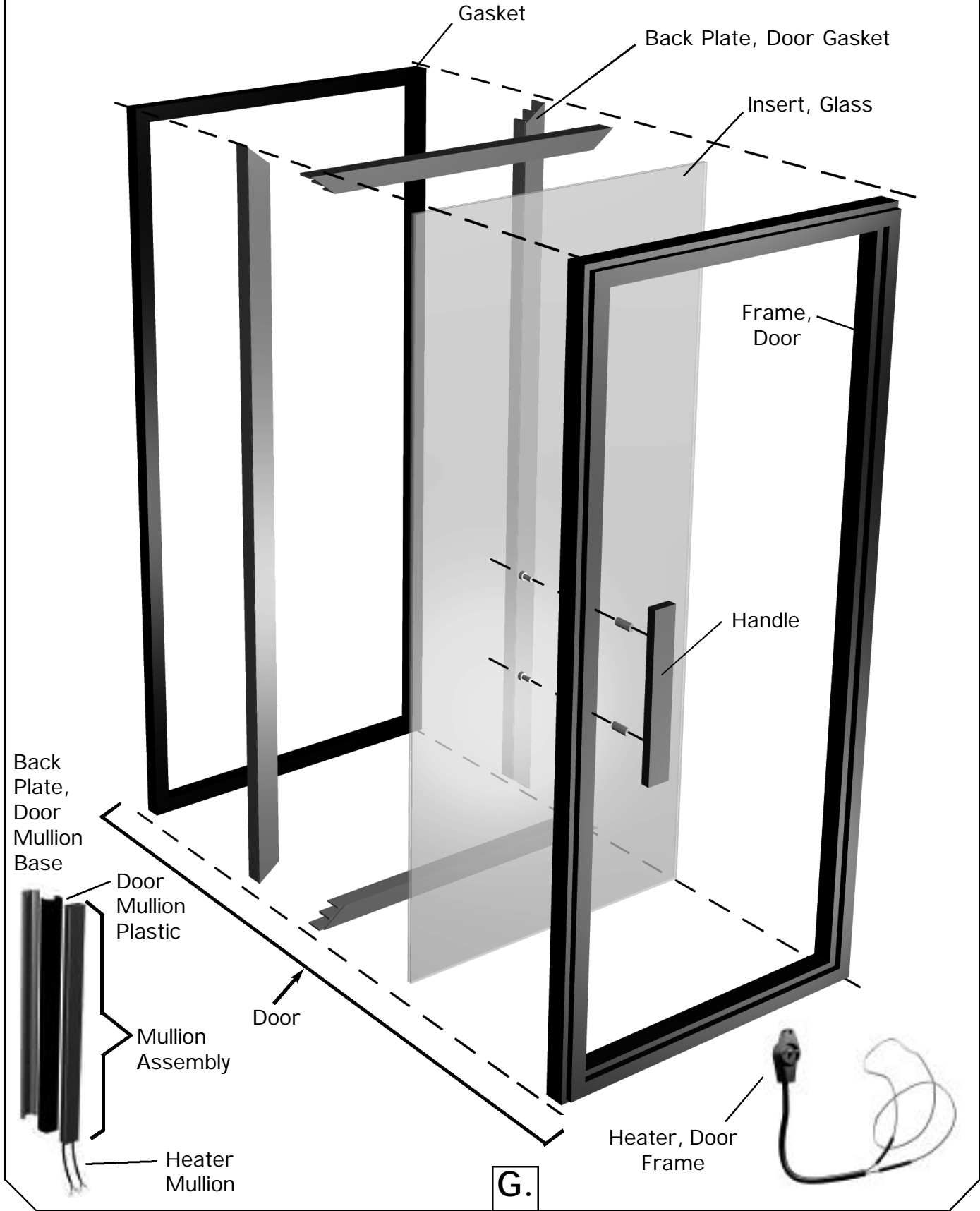

Door Parts

GDM Freezer Door Hinges

GDM-7F Kit, Door Hinge Top

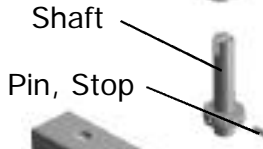
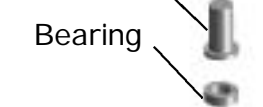
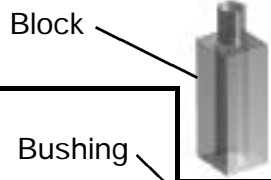
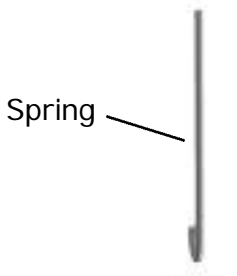
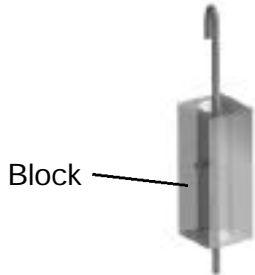
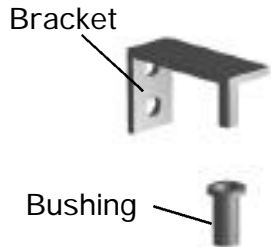

Kit, Door Hinge Bottom

GDM-6F, GDM-10F Kit, Door Hinge Top

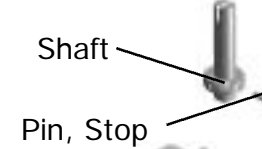
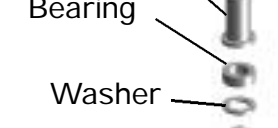
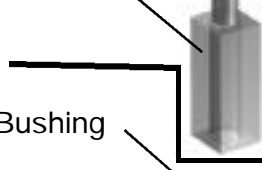
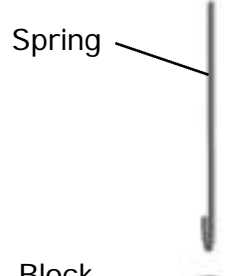
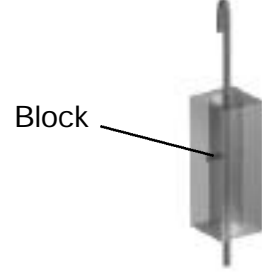
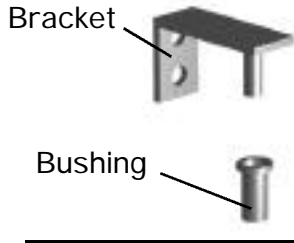

Kit, Door Hinge Bottom

Before Serial NO. 1-1775723

GDM-12F Kit, Door Hinge Top

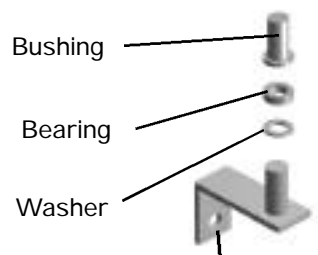
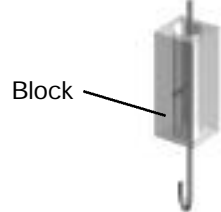
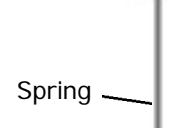
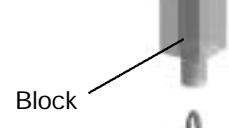
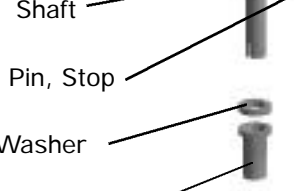
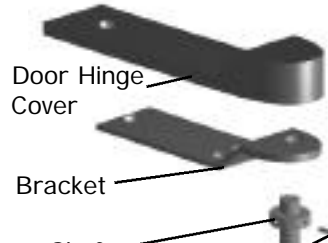

Kit, Door Hinge Bottom

H.

All Others Kit, Door Hinge Top

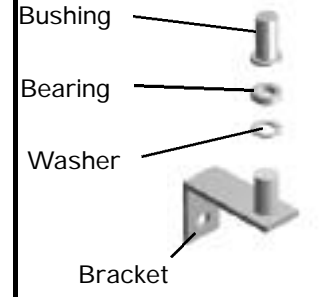
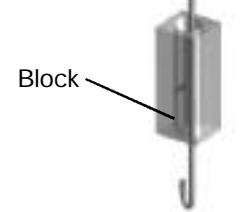
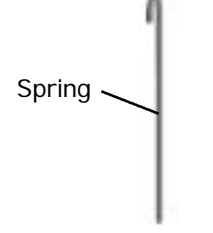
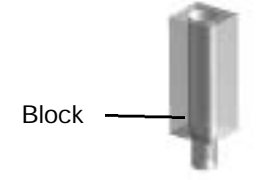
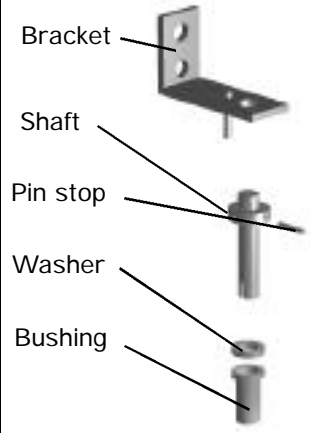

Kit, Door Hinge Bottom

Door Parts

GDM Freezer Models

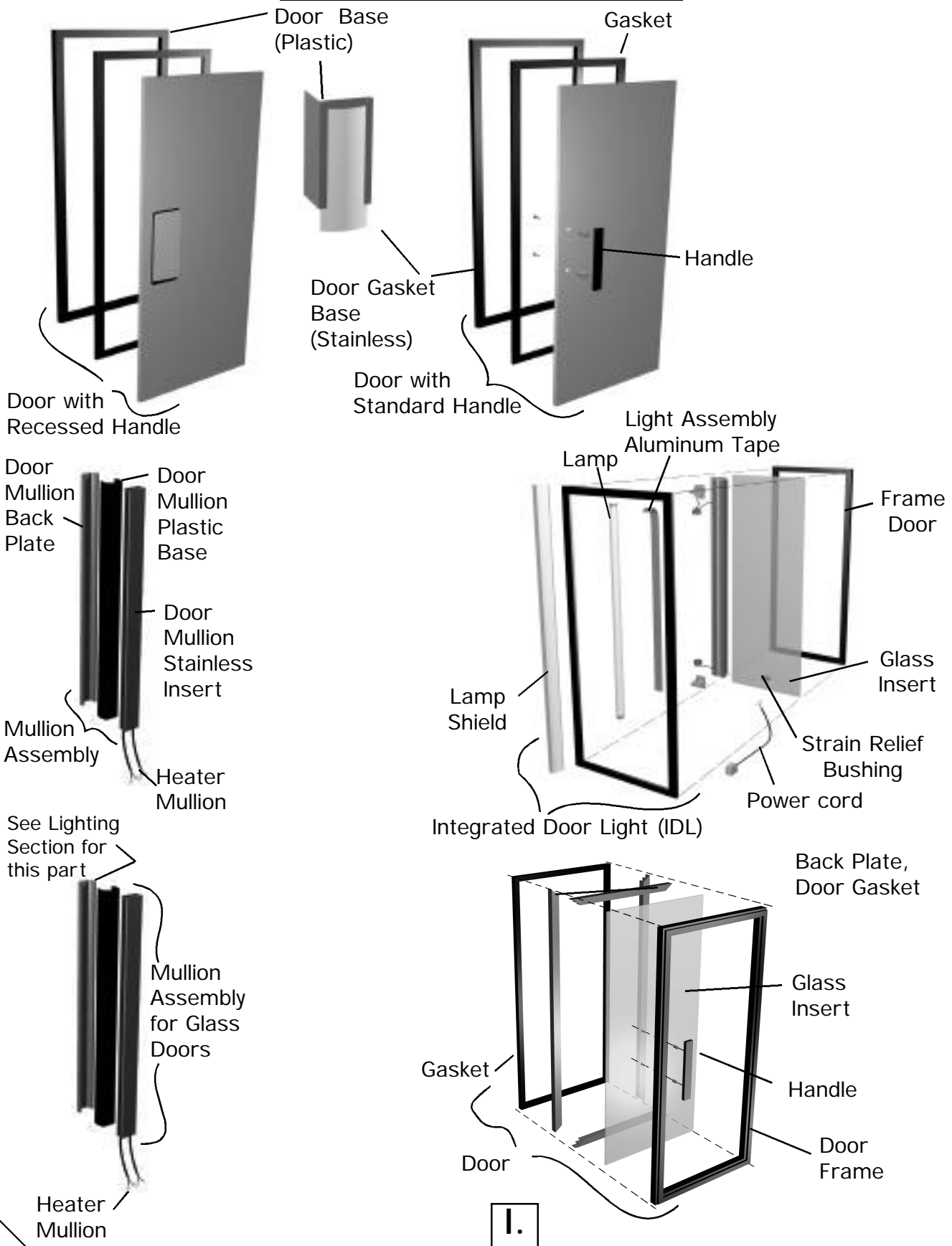

Evaporator Parts

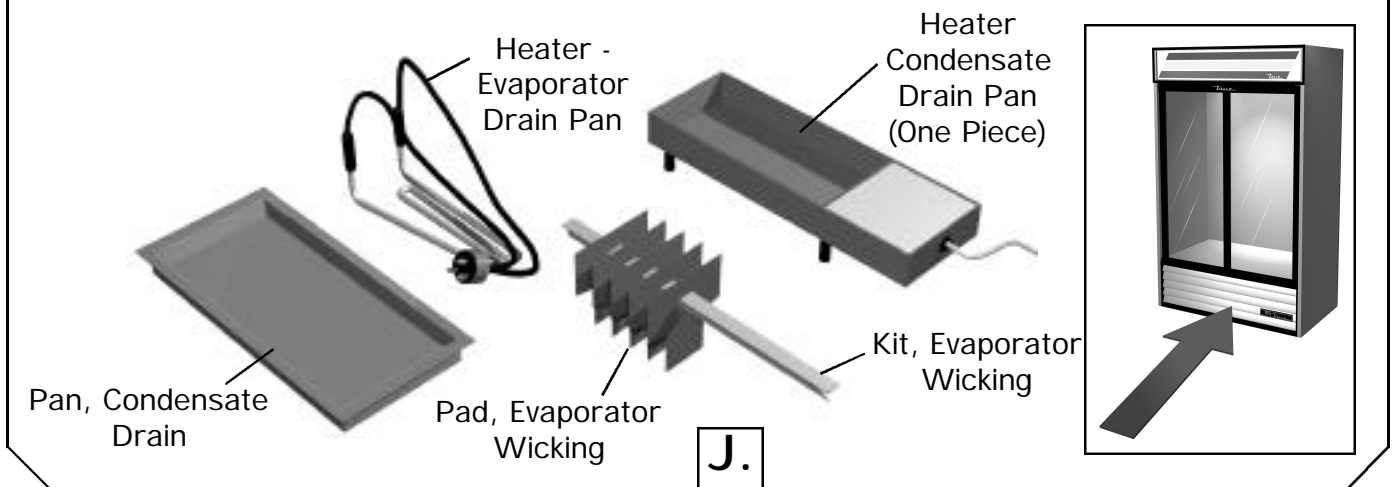
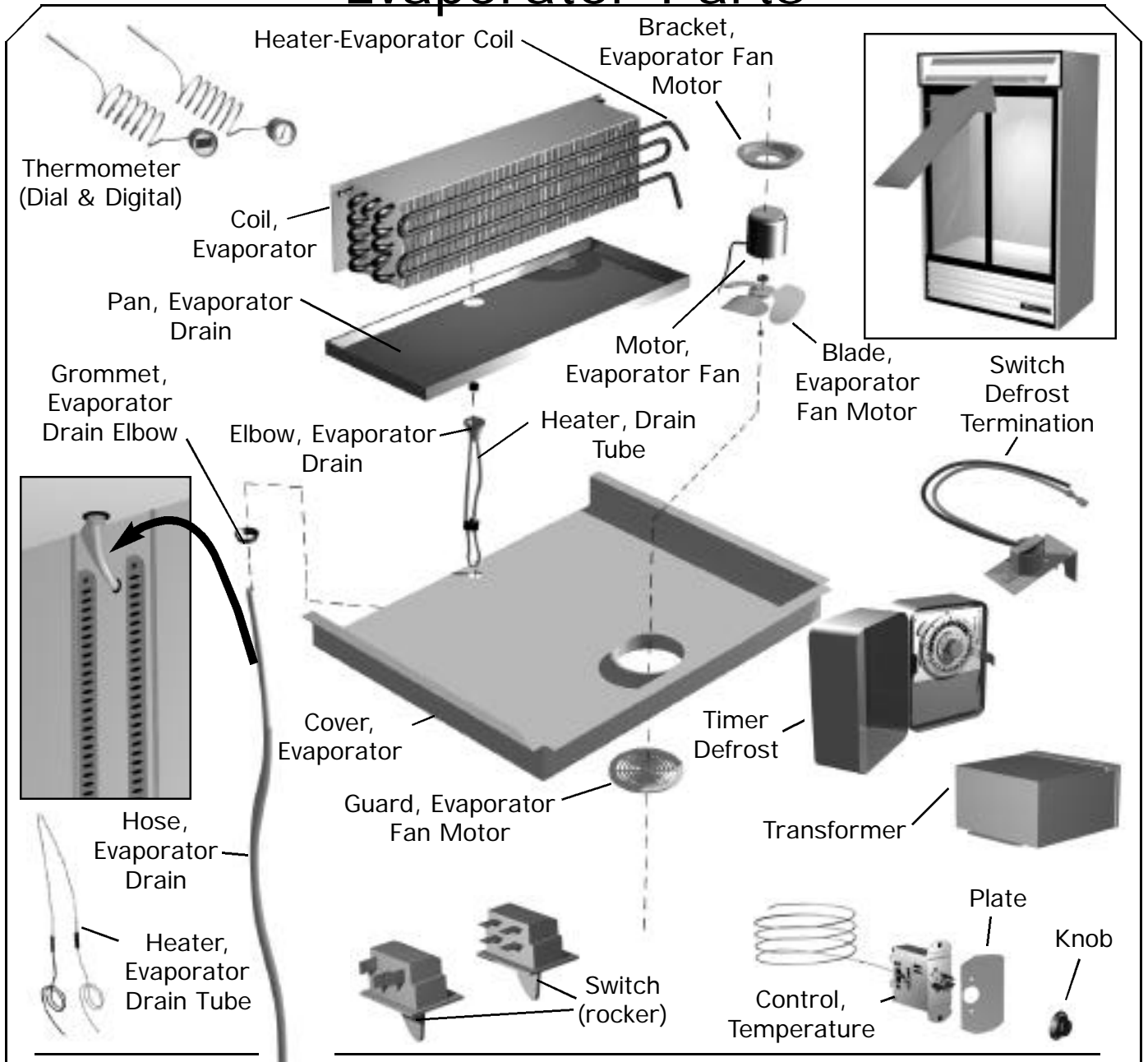

Grill Parts

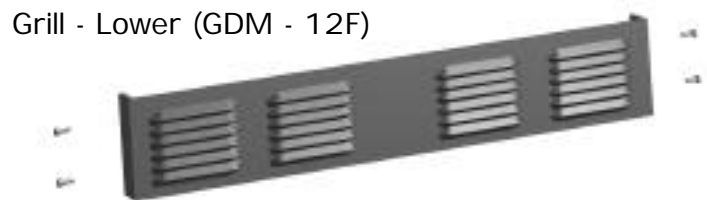
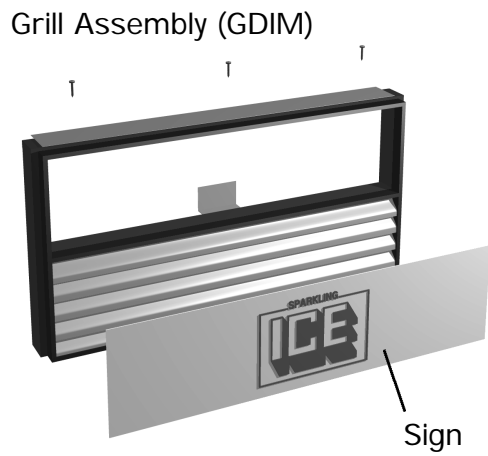
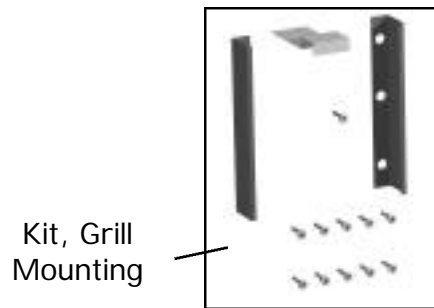
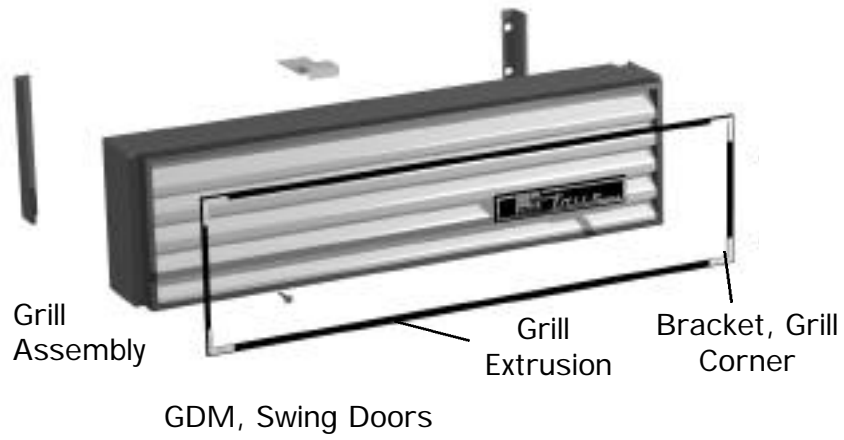

Lighting Parts

GDM Freezer Models

Light Assembly



Switch, Light
(Push Button)
801908

Switch, Light
(Toggle Style)
801901

Switch, Light
(Rocker Style)
842040

Lamp

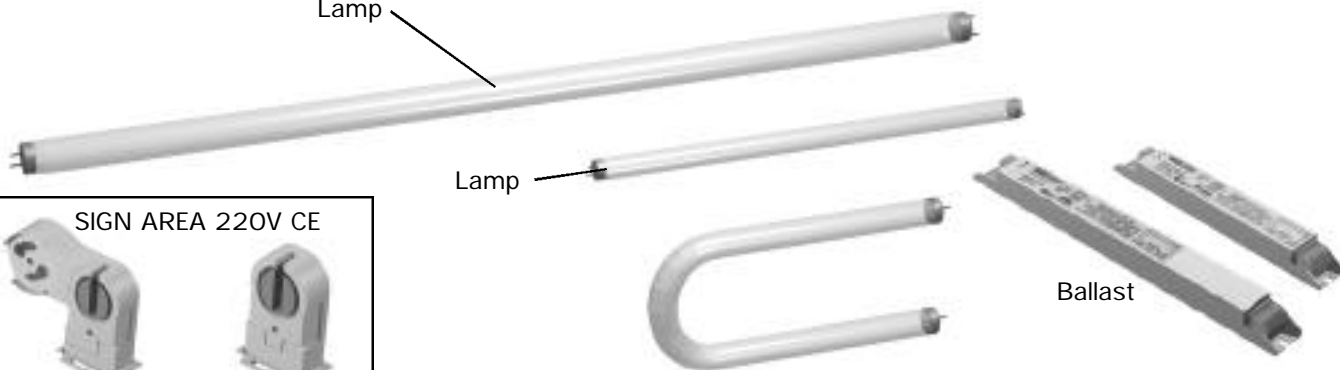

SIGN AREA 220V CE



225-C-13
842063



225-S/13
842062

Interior Lampholders
Non-IDL Top or Bottom
501.5 Kulka
801250



DOOR LAMPHOLDERS



For VHO Lamps
Top of IDL Door
#540 (w/53" Lead)
801359



For 24K Lamps
Top of IDL Door
#542 (52 3/4" Lead)
801230



Bottom of IDL Door
#540 (5 3/4" Lead)
801358



Bottom of IDL Door
#542 (4 1/2" Lead)
801254

SIGN AREA IDL AND NON-IDL
& CENTER MULLION FOR 24K
LAMPS



Springloaded
13570
801223



Stationary
13571
801224



842056



842054



842111



LR-110
801222

Lampholders



Starter



Base, Light
Starter



Lamp holder Sleeve



Base, Light
Starter 800510



Ballast, Sign
LC-14-20C

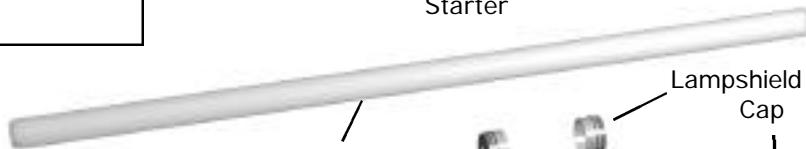

Lampshield

Lampshield End
Cap

L.

Shelf Parts

GDM Freezer Models

Backguard
Shelf Standard Bracket
Shelf Standard

Baffle, Air Back

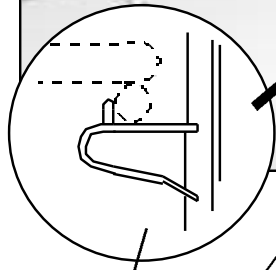
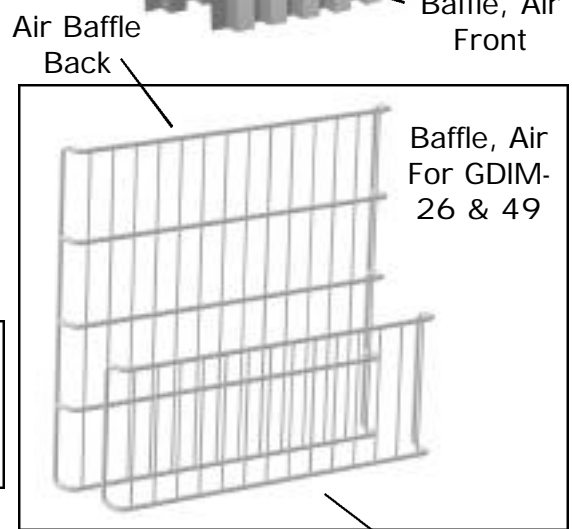
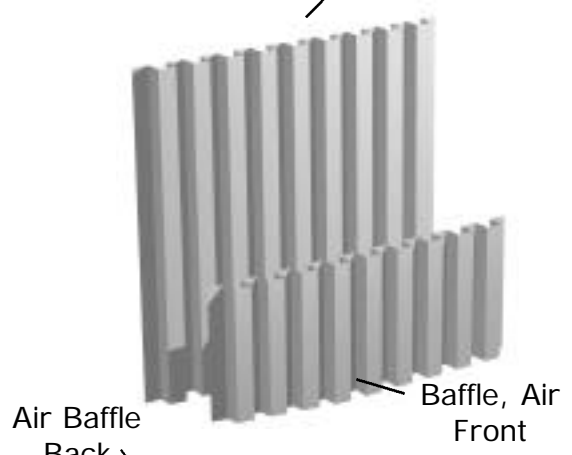
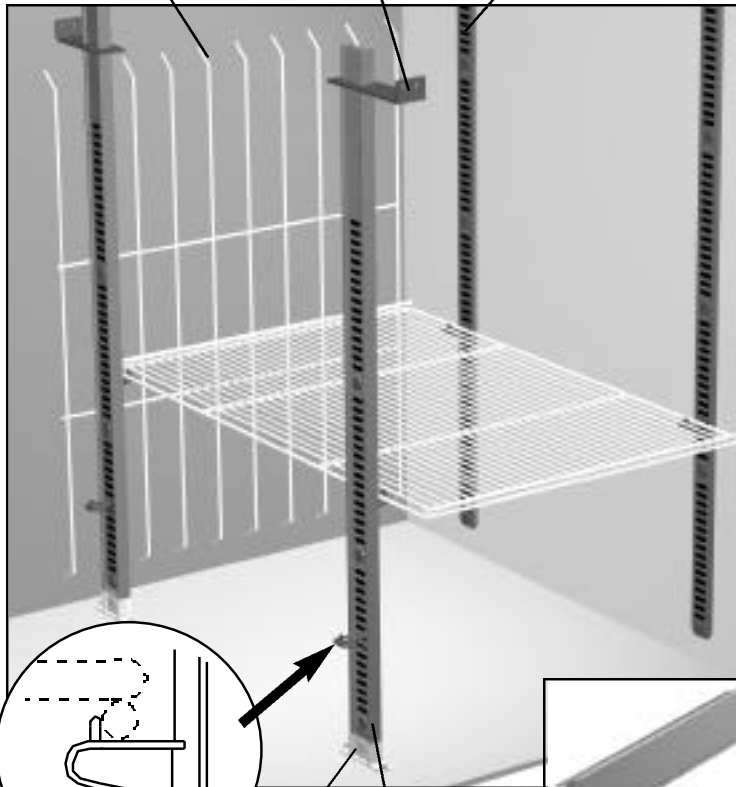

Clip, Shelf
Bracket, Shelf Standard
Shelf Standard (Center)

Wire Shelf Pricing Strip

Baffle, Air For GDM-26 & 49

Baffle, Air Front

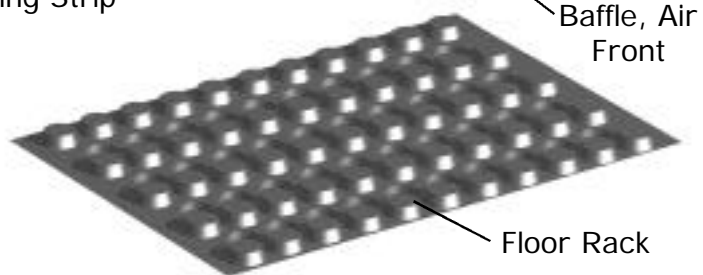

Floor Rack



Basket, Novelty

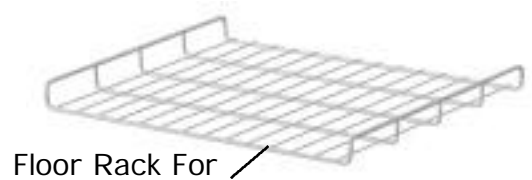

Floor Rack For GDM-60 & 26

M.

Sign & Sign Frame Parts

