

TRUE®

**T-49
T-49G**

**Parts Manual
115V**



T-49



T-49G

TO PLACE AN ORDER OR OBTAIN INFORMATION:

WEBSITE:

www.truemfg.com (Visit our Parts eStore at: <http://estore.truemfg.com>)
Parts Department e-mail address: parts@truemfg.com

SEND INQUIRIES TO:

TRUE MANUFACTURING COMPANY, INC. ATTN: PARTS DEPARTMENT
2001 EAST TERRA LANE • O'Fallon, Missouri 63366-4434 • U.S.A

CALL TOLL-FREE:

800-424-TRUE (Direct to Parts Department)
or 800-325-6152 (U.S.A & Canada only)
OR CALL: 636-240-2400

FAX: 636-272-9471

* At times changes and/or corrections may have been made to this parts manual after publication.
Please consult our Parts Department at 1-800-424-8783 for verification.

Castors, Legs & Levelers

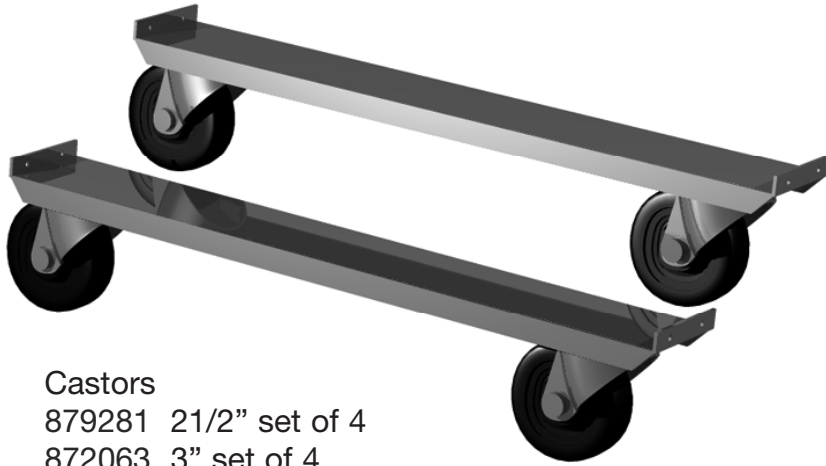

Castors

879281 2 1/2" set of 4

872063 3" set of 4

872010 4" set of 4



Castors

830280 2 1/2" set of 4

830277 4" set of 4



Legs

872001 6" set of 4



Legs, Siesmec
880348 6" set of 4



Legs
872025 6" set of 4

Compressors

8412509 1/2 HP Embraco (NEK6212Z)

*Motor, Condenser Fan
800439 after 11/8/05

*Cord, Power
(Compressor)
801797 (Embraco)



Condensing Unit
884939 -
(after 11/8/05)



Blade,
Fan Motor
Condenser
801006

*Accumulator
866743



*Cord,
Power
801701



Outlet, Compressor
801229

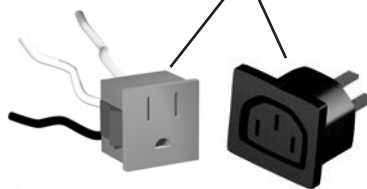

Bracket,
Fan Motor
865417

Block, Terminal

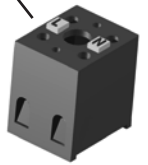

*Overload
842474

*Capacitor, start
911444
or 947400

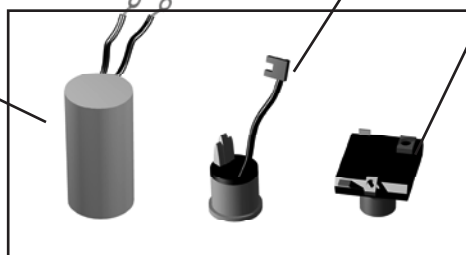

*Relay
842463 (Embraco)
802113

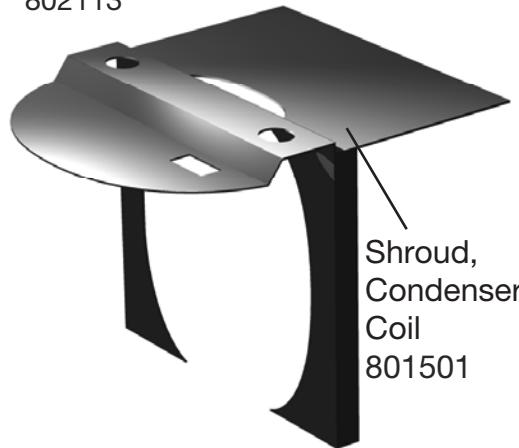

Shroud,
Condenser
Coil
801501

*Line Set 910802



Compressor Pull out
874525

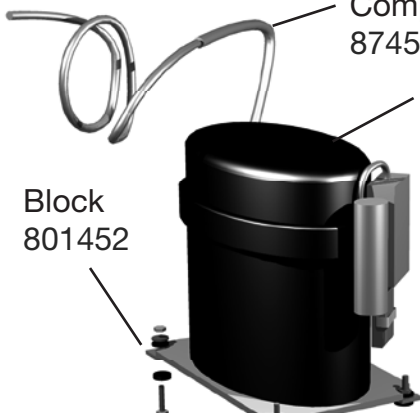

*Compressor
842509

Block
801452

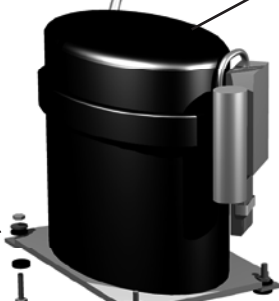

Coil, Condenser
800601

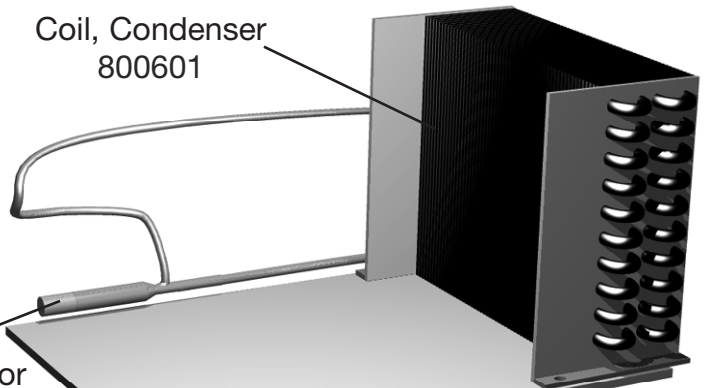

*Capillary
Tube
851134

Bolt, Compressor
831503

*Drier,
Compressor
800801 or
925928

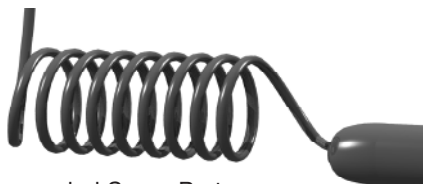

Base, Compressor
861074

2.

* Recommended Spare Parts

Door Parts

Door Hinges

T-Series Full Door

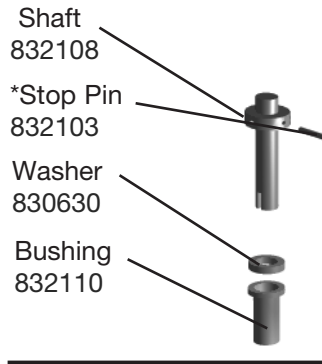

*Kit, Door Hinge Top

870865 - T-49
870865 - TS-49G RH/LH
933800 - TS-49G Left
933799 - TS-49G Right

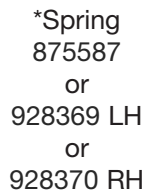
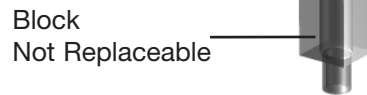

*Kit, Door Hinge Bottom

870866 - T-49
933106 - TS-49G Bottom,
Left, or Right

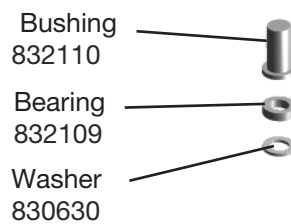
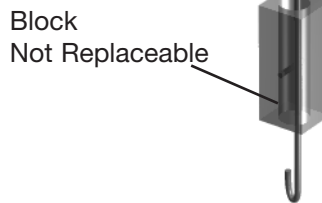

Door Parts - T-49

*Gasket 810719

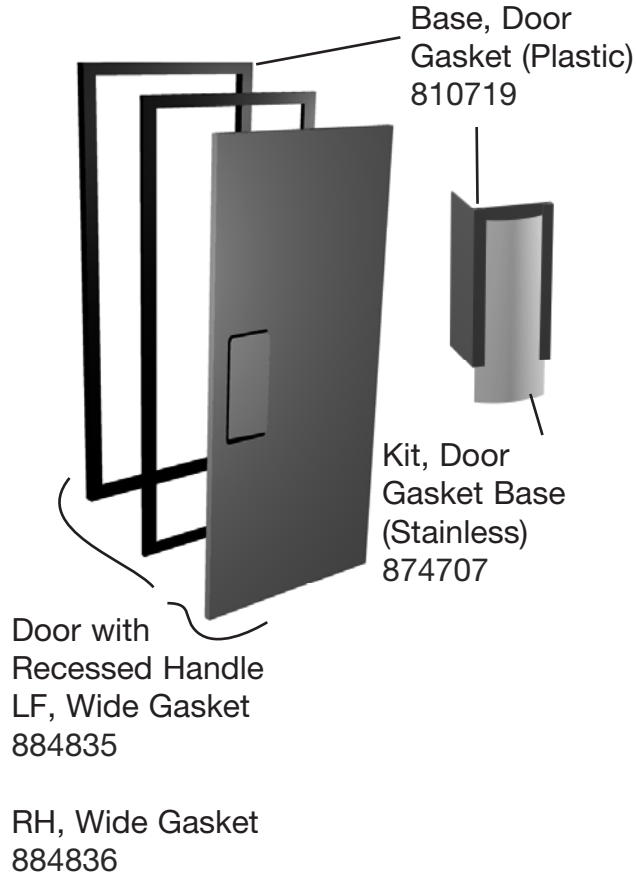

Door Locks

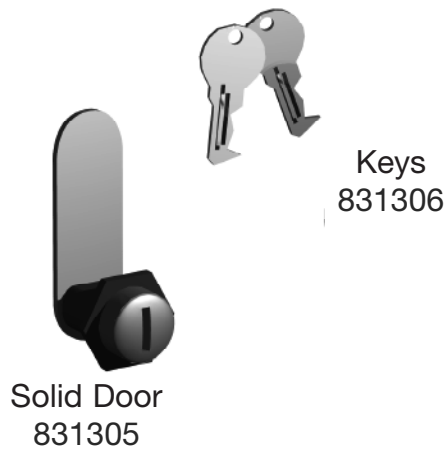

Locks (for T Models)
Cooler & Freezer

Door Parts - T-49G

T-Series & TS-Series Cooler Glass Swing Doors with Integrated Door Light (IDL)

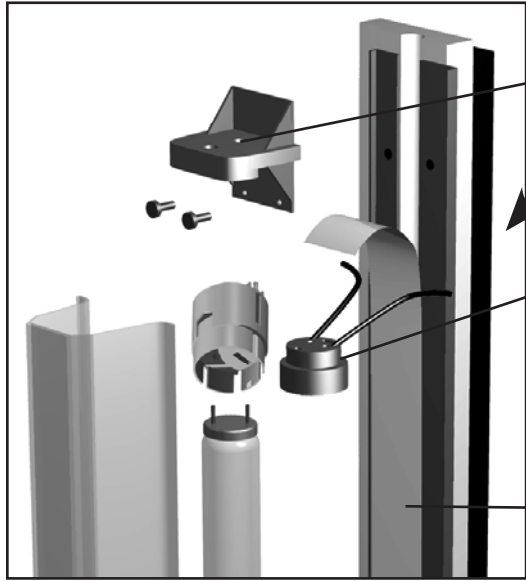

Base, Lampholder
841477

Lampholder Top
801230

Tape, Light Filler
Channel Aluminum
820204

Door

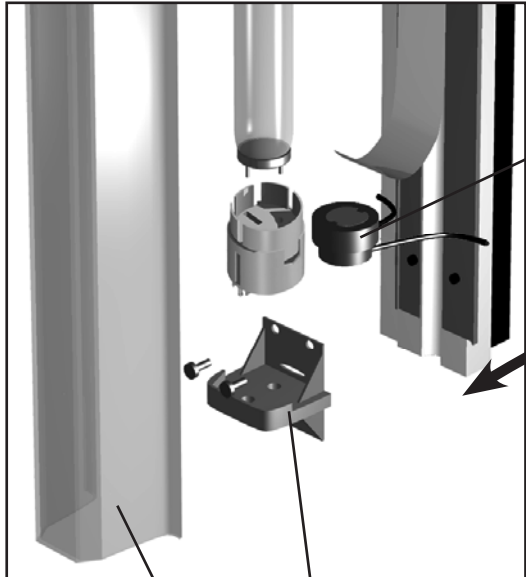

Lampholder Bottom
801254

Base, Lampholder
841477

Lamp Shield
810873

Lamp
801155

*Gasket
811125



*Cord, Power, Door "Y"
801732



Receptacle
878038

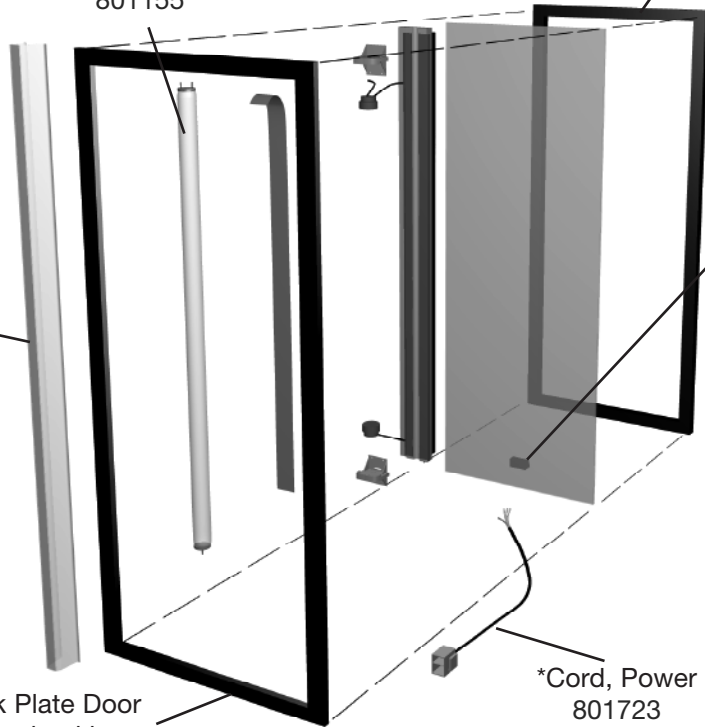

Bushing,
Strain Relief
811235

*Cord, Power
801723

Back Plate Door
Gasket kit
873008

* Recommended Spare Parts

5.

Door Parts - T-49G

T-Series & TS-Series Cooler Glass Swing Doors with Integrated Door Light (IDL)

Door



933711 - Left Hinged, Silver Framed, IDL Silver after 7/28/09 or

870668 - Left Hinged, Silver Framed, Non-IDL.

870667 - Right Hinged, Silver Framed Non-IDL

933712 - Door, Right hinged, silver frame, IDL, cartridge Spring after 8/12/09

Gasket
810719

Evaporator Parts

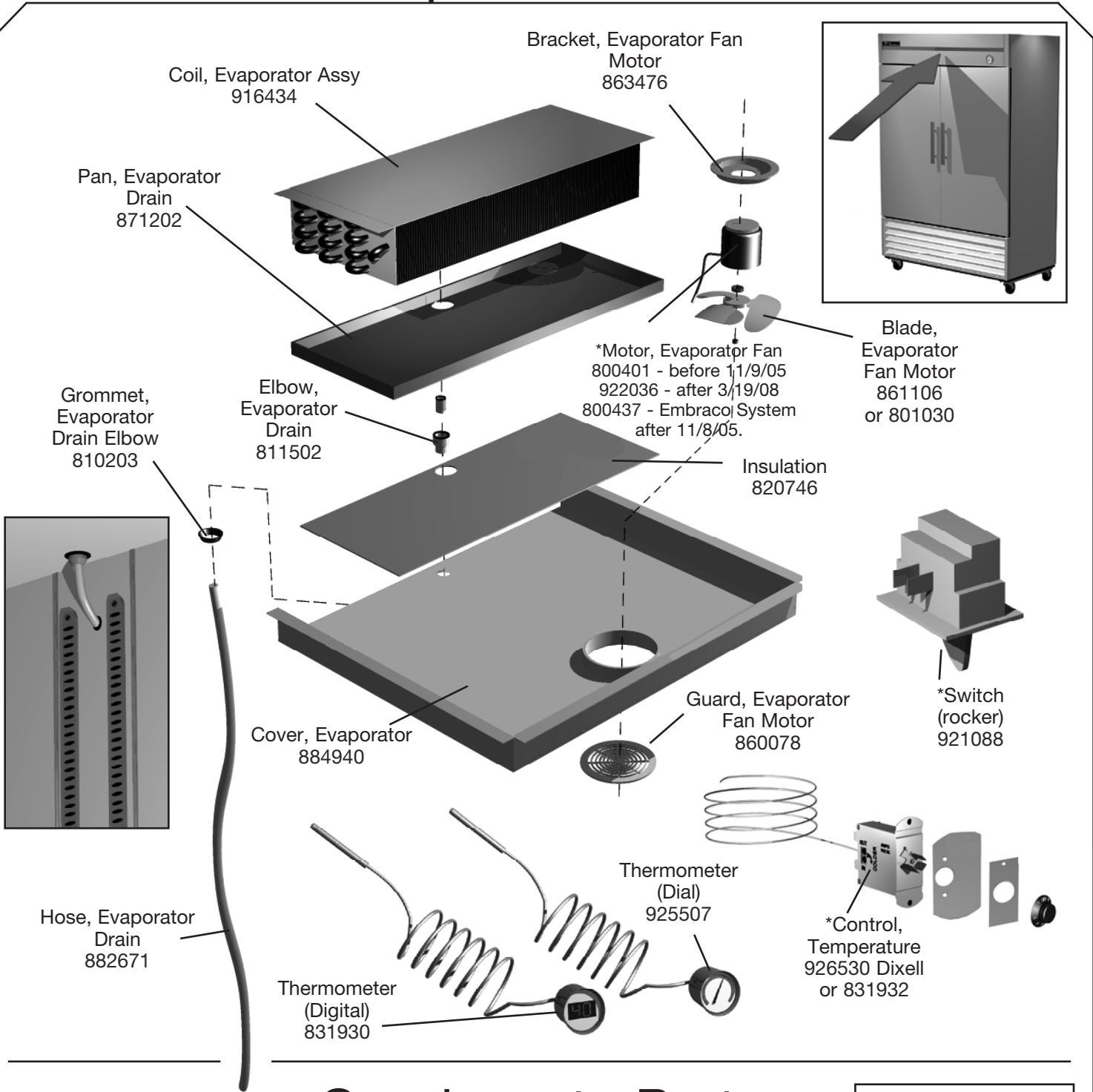

Condensate Parts

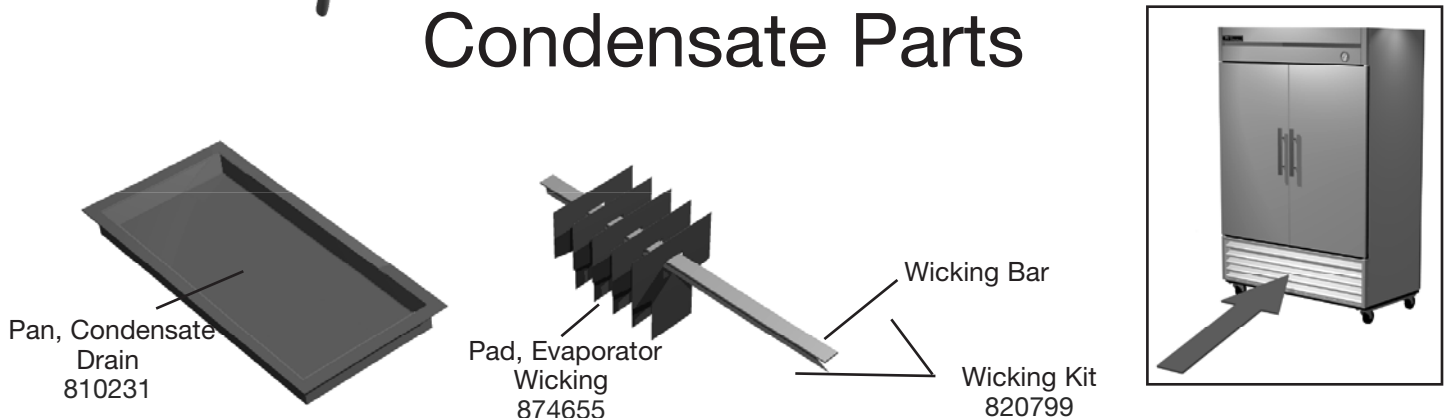

* Recommended Spare Parts

Grill Parts

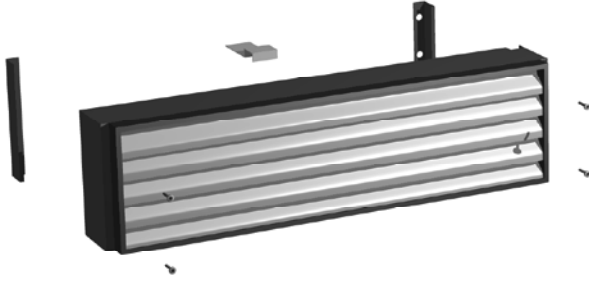

Rounded Front,
928665 - All LH, Stainless Steel
928666 - RH/LH, Stainless Steel
928664 - All RH, Stainless Steel
928694 - All LH
928693 - All RH
928695 - RH/LH

Grill Mounting Kit
928725

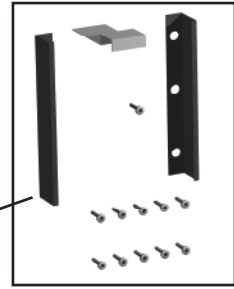

Lighting Parts



*Switch Rocker 2 Prong
(Refrigerator)
921088

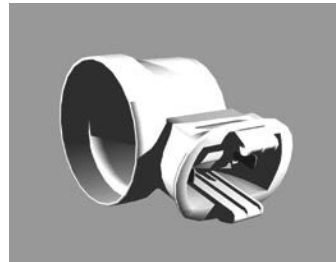

801266 after 9/2



Lamp Bulb
801155 after 11/28/00

Shelf Parts

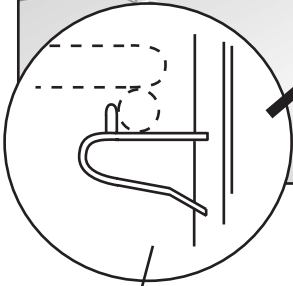
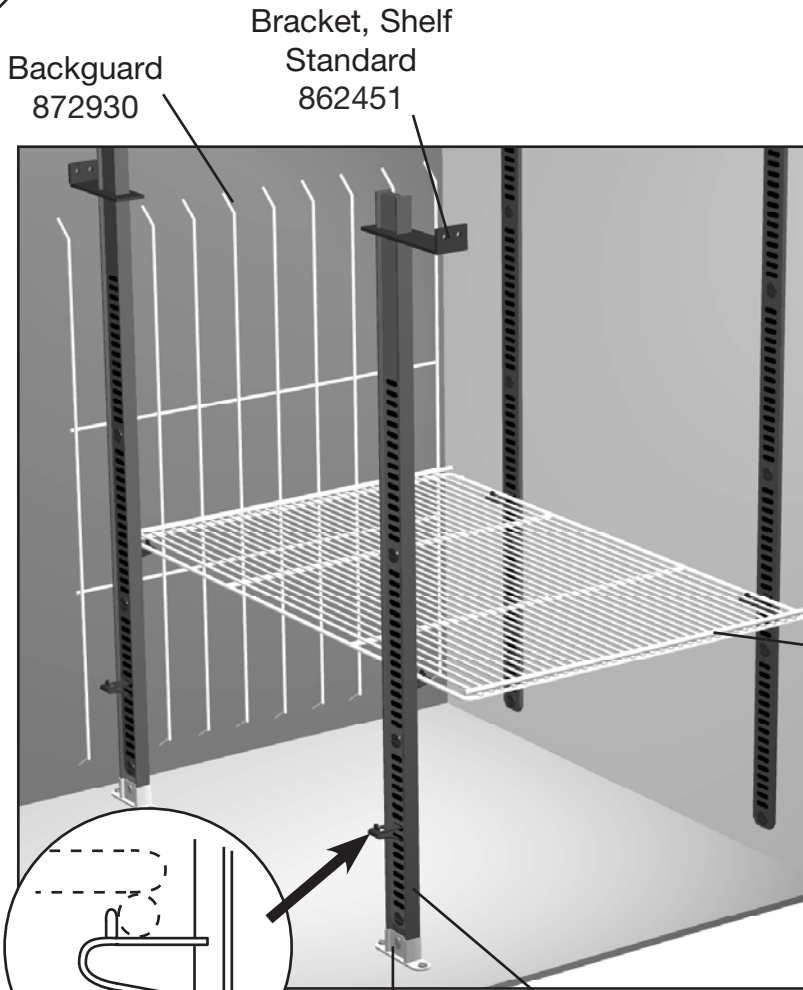

Bracket, Shelf Standard Bottom 830185

Bun Tray Rack
 Full Door 871729
 Half Door 871728

Shelf White 871781

Bar 880251

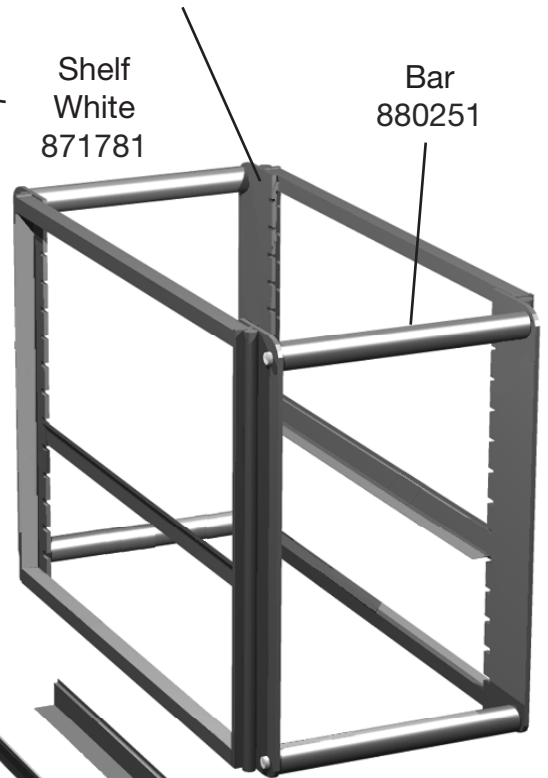

Slide, Bun Tray Standard 871754
 Universal 871755

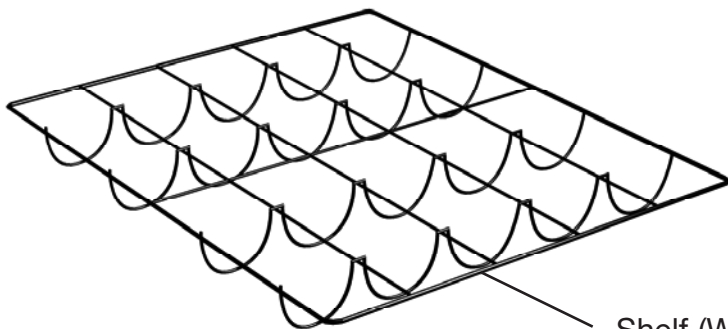

Shelf (Wine Rack Style) 879202

T-49 115v w/Suggested spare parts

Part #	Description	CS Info
866743	ACCUMULATOR	
872930	BACKGUARD KIT, WHITE WIRE	
929778	BACKSCREEN KIT, BLACK ALUMINUM	PERFORATED METAL THAT COVERS COMPRESSOR AREA IN REAR OF CABINET TO PREVENT ACCESS.
861074	BASE, COMPRESSOR, METAL PLATFORM	
861301	BASE, GASKET, PERIMETER STAINLESS, VERTICAL CENTER MULLION	LOCATED ON CABINET BETWEEN THE DOORS
873016	BASE, MULLION, VERTICAL, BLACK PLASTIC	(DRAWING #905256)
832056	BASKET, NOVELTY, WHITE, 19 1/4"W X 17 1/8"D	MUST SET ON SHELF
832055	BASKET, NOVELTY, WHITE, 19-1/4"W X 22"D	SETS ON A SHELF. 3 DIVIDERS INCLUDED.
832109	BEARING, THRUST, DOOR HINGE	
801006	BLADE, FAN MOTOR, CONDENSER	
861106	BLADE, FAN MOTOR, EVAPORATOR	
801030	BLADE, FAN MOTOR, EVAPORATOR, 115V FOR EMBRACO SYSTEM	**NOTE FACTORY DATES: USED AFTER 11/8/05 PRODUCTION OR SERIAL NO. 1-4310405 FOR PACIFIC PRODUCTION. USED AFTER 11/20/05 PRODUCTION DATE OR SERIAL NO. 1-43101879FOR BOWLING GREEN PRODUCTION.
801452	BLOCK, COMPRESSOR MOUNTING	
928725	BRACKET KIT, GRILL T-49, TS-53 FOR MAGNETIC GRILLS	
864970	BRACKET, BACKSCREEN GUARD, END PIECE, BLACK	REQUIRES 4 PER GUARD. ONE FOR EACH END OF GUARD, AND ONE EACH TOP CORNER.
864487	BRACKET, BACKSCREEN, MIDDLE FOR POWER CORD, BLACK	REQUIRES 1 PER CABINET.
867519	BRACKET, CENTER CABINET BACK SUPPORT	
862690	BRACKET, CENTER DOOR SUPPORT	USED ONLY WHEN ALL DOORS HINGED RIGHT OR ALL LEFT
865417	BRACKET, FAN MOTOR, CONDENSER	
863476	BRACKET, FAN MOTOR, EVAPORATOR, SHALLOW, 115V	115V**NOTE FACTORY DATES: USED AFTER 11/8/05 PRODUCTION OR SERIAL NO. 1-4310405 FOR PACIFIC PRODUCTION. USED AFTER 11/20/05 PRODUCTION DATE OR SERIAL NO. 1-43101879FOR BOWLING GREEN PRODUCTION.
861832	BRACKET, GRILL, CENTER TOP	
862451	BRACKET, SHELF STANDARD, TOP	USED AFTER OCTOBER 1999. HAS WIDE I BEAM CUTOUT. REPLACES BRACKET PREVIOUSLY USED W/ NARROW CUTOUT.
842231	BRUSH, CLEANING, CONDENSER COIL	OPTION ONLY
914705	CAP, START CAPACITOR	USED W/ NEK6212Z COMPRESSOR
911444	CAPACITOR, START, 115V 60 HZ R-134A 1/2HP FOR EMBRACO COMPRESSOR	USED AFTER 11/8/05 OR APPROX, SERIAL NO. 1-4317432
851134	CAPILLARY TUBE, R-134A	
830434	CASTOR COASTER	
872063	CASTOR KIT, FRAMED, SET/4	(OPTION) 3" CASTORS W/ 27" FRAMES RAISES CABINET ~3 3/4"
872010	CASTOR KIT, FRAMED, SET/4	(OPTION) 4" CASTORS W/ 27" FRAMES RAISES CABINET ~4 7/8"
879281	CASTOR KIT, FRAMED, SET/4	(OPTION) 2 1/2" CASTORS W/ 27" FRAMES RAISES CABINET ~3 1/2"
830280	CASTOR, SET/4, 2-1/2" 1/2" STEM	OPTION. SILVER HOUSING. USE FOR SER. NO.(1- 793556 - 1005582) (1-1088851 & AFTER)
830277	CASTOR, SET/4, 4", 1/2" STEM	STANDARD CASTOR. FOR SER. NO. (1- 793556 - 1005582) (1-1088801 & AFTER).
861942	CLAMP, COMPRESSOR	
920158	CLIP KIT, SHELF (SET/4)	
918740	CLIP, OVERLOAD MOUNTING	*USED AFTER 6/5/06 PRODUCTION DATE OR APPROX SERIAL NO. 1-4379187 IN MEX...OR AFTER 6/21/06 PRODUCTION DATE OR APPROX SERIAL NO. 1-4531945 FOR BLDG. 8.
831600	CLIP, SHELF	Requires 4 per shelf
830301	CLIP, SHROUD, CONDENSER COIL	REQUIRES 2
922914	CLIP, THERMOMETER SLEEVE	USED TO MOUNT DISPLAY PROBE. PCN 3866
800601	COIL, CONDENSER	
916434	COIL, EVAPORATOR ASSEMBLY 115V EMBRACO SYSTEM	USED AFTER 11/8/2005 FOR PACIFIC PRODUCTION & USED AFTER 11/20/2005 FOR BOWLING GREEN PRODUCTION.
842509	COMPRESSOR, 115V 60HZ, R-134A 1/2HP EMBRACO	**NOTE FACTORY DATES: USED AFTER 11/8/05 PRODUCTION OR SERIAL NO. 1-4310405 FOR PACIFIC PRODUCTION. USED AFTER 11/20/05 PRODUCTION DATE OR SERIAL NO. 1-43101879FOR BOWLING GREEN PRODUCTION.
884939	CONDENSING UNIT, 115V 60HZ, R134A 1/2HP	**NOTE FACTORY DATES: USED AFTER 11/8/05 PRODUCTION OR SERIAL NO. 1-4310405 FOR PACIFIC PRODUCTION. USED AFTER 11/20/05 PRODUCTION DATE OR SERIAL NO. 1-43101879FOR BOWLING GREEN PRODUCTION.
842088	CONNECTOR, INSULATE QUICK SLIDE FEMALE, ROCKER SWITCH	USED TO INSULATE THE UNUSED ROCKER SWITCH TERMINAL WHEN USING THE THREE PRONG SWITCH ON COOLERS
801302	CONNECTOR, LAMPHOLDER	USED AFTER 9/02 PRODUCTION DATE.
802179	CONNECTOR, TERMINAL, TEMPERATURE CONTROL, BLUE	
926530	CONTROL, TEMPERATURE, 115V, DIXELL	
831932	CONTROL, TEMPERATURE, 115V/208V/220V CE	

T-49 115v w/Suggested spare parts

922814	COPPER REDUCER 1/2 TO 3/8" FOR SUCTION LINE TO PULLOUT	
937374	CORD KIT, 115V EMBRACO COMPRESSOR POWER CORD/CORD KIT	8 PIN AMP CONNECTOR FOR COMPRESSOR POWER CORD AND CORD KIT W/ 8 PIN CONNECTOR THAT CONNECTS START COMPONENTS TO COMPRESSOR POWER CORD
917607	CORD KIT, 115V EMBRACO FROM COMPRESSOR POWER CORD TO START COMPONENTS	USED W/ EMBRACO COMPRESSORS
801797	CORD, POWER, COMPRESSOR, 115V FOR EMBRACO COMPRESSOR ONLY	*NOTE FACTORY DATES: USED AFTER 11/8/05 PRODUCTION OR SERIAL NO. 1-4310405 FOR PACIFIC PRODUCTION. USED AFTER 11/21/05 PRODUCTION DATE OR SERIAL NO. 1-4310180 FOR BOWLING GREEN PRODUCTION.
801701	CORD, POWER, MAIN, 115V, 108"	
801766	CORD, POWER, MAIN, 115V, 132" (11 FOOT), SPECIAL APPLICATION	CAN BE USED WHENEVER CUSTOMER NEEDS LONGER CORD.
892621	COVER, CAPILLARY SUCTION LINE, STAINLESS, RADIUS TANK	
865450	COVER, CAPILLARY SUCTION LINE, WHITE, RADIUS TANK	
842494	COVER, COMPRESSOR START COMPONENT	
914717	COVER, COMPRESSOR START COMPONENT	USED W/ NEK6212Z COMPRESSOR
860540	COVER, ELECTRICAL BOX, 115V	
860078	COVER, EVAP FAN MOTOR BLADE WHITE ALUMINUM (GUARD)	
860075	COVER, EVAP FAN MOTOR BLADE WHITE ALUMINUM (GUARD), 115V	**NOTE FACTORY DATES: USED AFTER 11/8/05 PRODUCTION OR SERIAL NO. 1-4310405 FOR PACIFIC PRODUCTION. USED AFTER 11/20/05 PRODUCTION DATE OR SERIAL NO. 1-43101879 FOR BOWLING GREEN PRODUCTION.
884940	COVER, EVAPORATOR COIL, WHITE, 115V, ONE FAN OPENING, EMBRACO SYSTEM	*NOTE FACTORY DATES: USED AFTER 11/8/05 PRODUCTION OR SERIAL NO. 1-4310405 FOR PACIFIC PRODUCTION. USED AFTER 11/20/05 PRODUCTION DATE OR SERIAL NO. 1-4310179 FOR BOWLING GREEN PRODUCTION.
864703	COVER, MULLION, BACK, STAINLESS, WESTLYNN	
810391	COVER, TEMPERATURE CONTROL, MOLDED PLASTIC	OPTION FOR ALL VOLTAGES. PLASTIC COVER TO KEEP PEOPLE FROM ADJUSTING TEMPERATURES
860602	COVER, TEMPERATURE CONTROL, WHITE	(W/O ROCKER SWITCH HOLE)
911436	COVER, TEMPERATURE CONTROL, WHITE(USED FOR ELECTRONIC CONTROL)	USED TO COVER HOLE IN EVAPORATOR HOUSING. ELECTRONIC CONTROL IS MOUNTED IN RAINSHIELD. USED BY VRESSO BEBANON
894755	COVER, TEMPERATURE CONTROL/LIGHT SWITCH CLEAR ALUMINUM FOR GE CONTROL	USED W/ 831932 GE CONTROL (PCN #2943)
894753	COVER, TEMPERATURE CONTROL/LIGHT SWITCH WHITE ALUMINUM FOR GE CONTROL	USED W/ 831932 GE CONTROL (PCN #2943)
880251	CROSS BAR, BUN TRAY RACK, 18-3/16"	FOR BUN TRAY RACK 20 7/8"W X 24"D
938752	DIGITAL VACUUM GAUGE, DIGITAL	
910448	DIVIDER ASSEMBLY, NOVELTY BASKET, LARGE, WHITE	USED W/ 832055 BASKET
832057	DIVIDER, NOVELTY BASKET, SMALL, WHITE	FOR SMALL BASKET PART NO. 832056
870684	DOOR, LEFT HINGED, STAINLESS, 15" HANDLE	
884835	DOOR, LEFT HINGED, STAINLESS, RECESSED HANDLE, WIDE DOOR GASKET, REFRIGERATOR	USED AFTER 11/29/05 APPROXIMATE PRODUCTION DATE OR #4319998 FOR BOWLING GREEN BUT CHECK SPECIAL SERIAL NUMBER LIST FOR EXCEPTIONS. USED AFTER 12/05 APPROXIMATE PRODUCTION DATE IN PACIFIC.
870683	DOOR, RIGHT HINGED, STAINLESS, 15" HANDLE	
884836	DOOR, RIGHT HINGED, STAINLESS, RECESSED HANDLE, WIDE DOOR GASKET, REFRIGERATOR	USED AFTER 10/05 APPROXIMATE PROD. DATE IN BOWLING GREEN BUT CHECK SPECIAL SERIAL NUMBER LIST FOR EXCEPTIONS. USED AFTER 12/05 APPROXIMATE PRODUCTION DATE IN PACIFIC.
863105	ELECTRICAL BOX	
921089	FACE PLATE, ROCKER SWITCH, BLACK	STARTED USING ~FEBRUARY 2008 (PCN #3917) REPLACES THE 810368 WHITE FACE-PLATE PREVIOUSLY USED.
831998	FACEPLATE, THERMOMETER, CELCIUS, DIXEL X420C ()	
810719	GASKET, DOOR, MAGNETIC (NWDG)	USED AFTER 11/29/05 APPROXIMATE PRODUCTION DATE OR #4319998 FOR BOWLING GREEN BUT CHECK SPECIAL SERIAL NUMBER LIST FOR EXCEPTIONS. USED AFTER 12/05 APPROXIMATE PRODUCTION DATE IN PACIFIC.
928694	GRILL KIT, ALL LEFT HINGE, MAGNETIC WITH MOUNTING BRACKETS	USED TO RETROFIT OLDER STYLE GRILLS USED BEFORE 1/6/2009 (PCN #4115)
928693	GRILL KIT, ALL RIGHT HINGE, MAGNETIC WITH MOUNTING BRACKETS	USED TO RETROFIT OLDER STYLE GRILLS USED BEFORE 1/6/2009 (PCN #4115)
928695	GRILL KIT, RIGHT HINGE/LEFT HINGE, MAGNETIC WITH MOUNTING BRACKETS	USED TO RETROFIT OLDER STYLE GRILLS USED BEFORE 1/6/2009 (PCN #4115)
928665	GRILL, ASSEMBLY, STAINLESS, ALL LEFT HINGE, ROUNDED, MAGNETIC	GRILL IS ROUNDED AND MOUNTING IS MAGNETIC. USE KIT TO RETROFIT OLD STYLE GRILLS.. PCN 4115
928664	GRILL, ASSEMBLY, STAINLESS, ALL RIGHT HINGE, ROUNDED, MAGNETIC	GRILL IS ROUNDED AND MOUNTING IS MAGNETIC. USE KIT TO RETROFIT OLD STYLE GRILLS.. PCN 4115
928666	GRILL, ASSEMBLY, STAINLESS, LEFT HINGE/RIGHT HINGE, ROUNDED, MAGNETIC	GRILL IS ROUNDED AND MOUNTING IS MAGNETIC. USE KIT TO RETROFIT OLD STYLE GRILLS.. PCN 4115
810203	GROMMET, DRAIN ELBOW	SERVES AS A PROTECTION ONLY AROUND HOLE CUT IN EVAPORATOR HOUSING FOR DRAIN ELBOW. DOES NOT SERVE AS A WASHER FOR SEALING DRAIN ELBOW.
875545	HANDLE, DOOR, STAINLESS, SOLID DOORS	HOLES DRILLED ON HANDLE AND DOOR 8-1/8" APART. USED ON SOLID DOORS.
928642	HEATER KIT, CONDENSATE PAN	USED FOR FIELD INSTALL. 927642 HEATED DRAIN PAN SITS INSIDE OF 912540 METAL PAN. (FT #2388)
801801	HEATER, DOOR MULLION, 115V	
870866	HINGE KIT, DOOR, BOTTOM LEFT OR RIGHT	

T-49 115v w/Suggested spare parts

870865	HINGE KIT, DOOR, TOP, RIGHT OR LEFT	
862006	HOLDER, CONDENSATE DRAIN PAN WICKING PAD, CLEAR ALUMINUM	
882671	HOSE, EVAPORATOR DRAIN	
820746	INSULATION, DRAIN PAN, EVAPORATOR	
831306	KEY, LOCK, DOOR	USED BEFORE 1/6/2009 W/ 831305/831357 LOCK ASSEMBLY
932992	KEY, LOCK, DOOR	USED AFTER 1/5/2009 W/ 831373 LOCK ASSEMBLY
873054	KIT, GASKET BASE, PERIMETER PLASTIC	LOCATED ON CABINET "NOT ON DOOR". SURROUNDS DOOR OPENING. THIS PIECE HOLDS PERIMETER STAINLESS (AND PERIMETER HEATER WIRE ON SOME MODELS). 4 PIECE ASSEMBLY.
874707	KIT, GASKET BASE, PERIMETER STAINLESS	LOCATED ON CABINET "NOT ON DOOR". SURROUNDS DOOR OPENING. INSERTS INTO PERIMETER PLASTIC. 4 PIECE ASSEMBLY.
918741	KIT, OVERLOAD/BRACKET, 115V 60 HZ R-134A, 1/3HP, FOR EMBRACO COMPRESSOR	*USED AFTER 6/5/06 PRODUCTION DATE OR APPROX SERIAL NO. 1-4379187 IN MEX...OR AFTER 6/21/06 PRODUCTION DATE OR APPROX SERIAL NO. 1-4531945 FOR BLDG. 8.
913366	KIT, START COMPONET FOR EMBRACO	**NOTE FACTORY DATES: USED AFTER 11/8/05 PRODUCTION OR SERIAL NO. 1-4310405 FOR PACIFIC PRODUCTION. USED AFTER 11/20/05 PROUDCTION DATE OR SERIAL NO. 1-43101879FOR BOWLING GREEN PRODUCTION.
880982	KNOB, TEMPERATURE CONTROL, DANFOSS	
831935	KNOB, TEMPERATURE CONTROL, GE	
875548	KNOB, TEMPERATURE CONTROL, RANCO/CUTLER HAMMER	
801112	LAMP, 115V	ONE LAMP STANDARD
801266	LAMPHOLDER, 115V/208V/220V	USED AFTER 9/02 PRODUCTION DATE. WILL REPLACE THE 801228 USED BEFORE.
872001	LEG KIT, 6" , SET/4, FRAME STYLE	OPTIONAL ANY SERIAL NUMBER
880348	LEG KIT, 6" SET/4, 1/2" DIA. STEM, SEISMIC	OPTION
872025	LEG KIT, 6", SET/4, 1/2" DIA. STEM	USED AFTER SER. NO. 1-793556 EXCEPT FOR (1-1005583 - 1-1088848)
910802	LINE SET, ACCUMULATOR/CAPILLARY TUBE/SUCTION LINE, T-49, R-134A EMBRACO	**NOTE FACTORY DATES: USED AFTER 11/8/05 PRODUCTION OR SERIAL NO. 1-4310405 FOR PACIFIC PRODUCTION. USED AFTER 11/20/05 PROUDCTION DATE OR SERIAL NO. 1-43101879FOR BOWLING GREEN PRODUCTION.
831373	LOCK, DOOR, STAINLESS (ONE PER DOOR)	STARTED USING ON 1/6/2009. REPLACES/RETROFITS PREVIOUS (831305/831357) LOCK ASSEMBLY. (PCN #4115) CABINET HAS TWO DOORS
926534	MAGNETIC CATCH, GRILL	
800439	MOTOR, CONDENSER FAN, 115V 60HZ, FOR EMBRACO COMPRESSOR	**NOTE FACTORY DATES: USED AFTER 11/8/05 PRODUCTION OR SERIAL NO. 1-4310405 FOR PACIFIC PRODUCTION. USED AFTER 11/20/05 PROUDCTION DATE OR SERIAL NO. 1-43101879FOR BOWLING GREEN PRODUCTION.
922036	MOTOR, EVAPORATOR FAN	USED AFTER 3/19/08 PRODUCTION DATE. REPLACES THE 800437 PREVIOUSLY USED. PCN #3968
800437	MOTOR, EVAPORATOR FAN, 115V FOR EMBRACO SYSTEM	**NOTE FACTORY DATES: USED AFTER 11/8/05 PRODUCTION OR SERIAL NO. 1-4310405 FOR PACIFIC PRODUCTION. USED AFTER 11/20/05 PROUDCTION DATE OR SERIAL NO. 1-43101879FOR BOWLING GREEN PRODUCTION.
881781	MOUNTING KIT, BACKSCREEN	
872925	MULLION ASSEMBLY, 115V, VERTICAL	
811502	NOZZLE, EVAPORATOR DRAIN, PLASTIC, WHITE (45 DEGREE ELBOW)	
801229	OUTLET/RECEPTACLE, COMPRESSOR POWER CORD, 115V/208V/220V NON CE	
842474	OVERLOAD, 115V 60 HZ R-134A, 1/3HP, FOR EMBRACO COMPRESSOR	*USED AFTER 6/5/06 PRODUCTION DATE OR APPROX SERIAL NO. 1-4379187 IN MEX...OR AFTER 6/21/06 PRODUCTION DATE OR APPROX SERIAL NO. 1-4531945 FOR BLDG. 8.
831920	PAD, WICKING	REQUIRES 5 TOTAL PADS
874655	PAD, WICKING (SET OF 5)	
891858	PAN, DRAIN, CONDENSATE, BOTTOM, METAL, OPTION	
912540	PAN, DRAIN, CONDENSATE, BOTTOM, METAL, WITH HOLE OPTION	USE WITH ONE PIECE-DRAIN PAN HEATER
810231	PAN, DRAIN, CONDENSATE, BOTTOM, PLASTIC	
871202	PAN, DRAIN, EVAPORATOR	
832103	PIN, STOP, DOOR HINGE	
801295	PLUG, HEATER, DRAIN PAN, 115V	WAS USED WITH 801815 OR 801817 115V DRAIN PAN HEATERS, WHICH ARE NO LONGER AVAILABLE
892206	POST, MULLION, STAINLESS STEEL, TRAY SLIDE SYSTEM	WILL NOT RETROFIT IN THE FIELD. FOR REPLACEMENT ONLY.
935910	PROBE, THERMOMETER	USED W/ 800400 THERMOMETER
926488	PRODUCT ID STRIP, WIRE SHELF, BLACK (48")	
873774	PRODUCT ID STRIP, WIRE SHELF, WHITE (48")	
810501	PROTECTOR, DOOR SPRING	THIS IS ONLY THE RUBBER COVER FOR A DOOR SPRING.
874525	PULLOUT ASSEMBLY, COMPRESSOR	
871729	RACK, BUN TRAY, FULL DOOR	FOR 18"(46CM) X 26"(66CM) SHEET PANS. COMES WITH 44 PAN SUPPORTS TO HOLD 22 PANS. MAXIMUM CAPACITY IS 32 PANS. SPACING OF NOTCHES ON VERTICAL SIDES OF RACK ARE 1-1/2" APART.
871728	RACK, BUN TRAY, HALF DOOR	FOR 18" X 26" PAN COMES WITH 22 PAN SUPPORTS TO HOLD 11 PANS. MAXIMUM CAPACITY IS 13 BUN PANS.
919828	RAIL ASSEMBLY, BLACK	

T-49 115v w/Suggested spare parts

871539	RAINSHIELD, FOR BOTH DOORS HINGED LEFT	
938631	RAINSHIELD, FOR BOTH DOORS HINGED LEFT W/ DIGITAL THERMOMETER	USED W/ RECTANGULAR DIGITAL THERMOMETER
871538	RAINSHIELD, FOR BOTH DOORS HINGED RIGHT	
938632	RAINSHIELD, FOR BOTH DOORS HINGED RIGHT W/ DIGITAL THERMOMETER	USED W/ RECTANGULAR DIGITAL THERMOMETER
938630	RAINSHIELD, FOR STANDARD HINGED 1 LEFT/1 RIGHT W/ DIGITAL THERMOMETER	USED W/ RECTANGULAR DIGITAL THERMOMETER
871502	RAINSHIELD, FOR STANDARD HINGED DOOR 1 LEFT/1 RIGHT	
842463	RELAY, 115V 60HZ R-134A 1/2HP, EMBRACO	**NOTE FACTORY DATES: USED AFTER 11/8/05 PRODUCTION OR SERIAL NO. 1-4310405 FOR PACIFIC PRODUCTION. USED AFTER 11/20/05 PRODUCTION DATE OR SERIAL NO. 1-43101879FOR BOWLING GREEN PRODUCTION.
800182	RELAY, TEMPERATURE CONTROL	FOR DANFOSS 077B7633 CONTROL
874654	RIVNUT TOOL, CASTOR OR LEG, 1/2" STEM	
874642	RIVNUT TOOL, KIT, SHELF STANDARD	
874640	RIVNUT TOOL, SHELF STANDARD	
861087	SCREEN, CONDENSER FAN MOTOR	
832108	SHAFT, DOOR HINGE	
917307	SHELF KIT, CHROME WIRE	
871719	SHELF KIT, STAINLESS STEEL	<<POSSIBLE 3-4 WEEK LEAD TIME DUE TO ELECTRO POLISHING>>
871781	SHELF KIT, WHITE WIRE	
861105	SHELF STANDARD, 47 3/8", CABINET SIDE & BACK, WHITE	STANDARD PRODUCTION
832195	SHELF STANDARD, 52", CABINET SIDE, STAINLESS STEEL	(OPTION) INCLUDE: 9)830501 MOUNTING SCREWS
879490	SHELF STANDARD, BACK CENTER, SILVER	
871807	SHELF STANDARD, BACK CENTER, WHITE	
872974	SHELF STANDARD, CABINET SIDE, WHITE, 52", OPTION	
871801	SHELF STANDARD, FRONT CENTER, SILVER	
871803	SHELF STANDARD, FRONT CENTER, WHITE	
801501	SHROUD, CONDENSER COIL	
801504	SHROUD, CONDENSER FAN MOTOR & BLADE	GOES OVER TOP CONDENSER SCREEN TO PROTECT HANDS FROM GOING INTO FAN AREA
867770	SLEEVE, TEMPERATURE CONTROL	
832320	SLEEVE, THERMOMETER	USED ONLY WITH LED TEMPERATURE DISPLAY. ONLY THE DISPLAY PROBE IS IN BRASS SLEEVE AND WRAPPED IN CORK TAPE PER PCN 3866
871754	SLIDE, BUN TRAY RACK, STANDARD	STANDARD RAILS THAT COME WITH THE BUN TRAY RACKS.
871755	SLIDE, BUN TRAY RACK, UNIVERSAL	WIDER RAIL THAT ALLOWS NARROWER PANS AS WELL AS THE WIDER PANS TO FIT INTO THE BUN TRAY RACK. (PURCHASED PART #832058)
875544	SPACER KIT, DOOR HANDLE, SILVER, SOLID DOOR	
875587	SPRING, HINGE, DOOR	
830170	STAND OFF, SHELF	
875510	STRIKER, ROCKER SWITCH , NO CHARGE PART	BLACK PLASTIC SHIM LOCATED ON TOP OF DOOR TO ACTIVATE ROCKER SWITCH AND PREVENT ROCKER SWITCH FROM TEARING DOOR GASKET. . REQUIRES 2) PER COOLER. PCN 4042 8/19/08 RETROFITS TO SHUT OFF POWER TO SERVICE.
801924	SWITCH, POWER, 115V	
921088	SWITCH, ROCKER, 3 PRONG, BLACK, LIGHT	REPLACES THE 801907 WHEN THE CENTER PRONG IS CAPPED WITH 842088 CONNECTOR
925507	THERMOMETER, DIAL, CELCIUS/FAHRENHEIT, ROUND EXTERIOR, BLACK FACED, STANDARD	REPLACES 831914 PREVIOUSLY USED (PCN #4115)
830426	THERMOMETER, DIAL, CELCIUS/FAHRENHEIT, ROUND INTERIOR HANGING	OPTION
822205	THERMOMETER, DIGITAL, CELCIUS, LED, 115V ROUND EXTERIOR,	WITH BUILT IN TRANSFORMER
831904	THERMOMETER, DIGITAL, CELSIUS, LED, ROUND	REQUIRES TRANSFORMER. IN PRODUCTION THIS WAS USED BEFORE 6/25/03. WHEN WE RUN OUT OF THESE THE 831930-FI CAN BE SENT AS A REPLACEMENT
800400	THERMOMETER, DIGITAL, FAHRENHEIT, LED, 115V, ROUND EXTERIOR	OPTION
831908	THERMOMETER, DIGITAL, FAHRENHEIT, ROUND EXTERIOR	OPTION
800321	THERMOMETER, TUBE TYPE, FAHRENHEIT/CELSIUS	
832270	TOOL, ADJUSTMENT, DANFOSS TEMPERATURE CONTROL	USED TO CALIBRATED DANFOSS CONTROL
831970	TRANSFORMER, THERMOMETER, 115V	REPLACES 831909 MODEL 015-0054-01
820799	WICKING KIT, CONDENSATE PAN	OPTION.
866524	WIRE HARNESS, 115V/208V/220V	
830271	WRENCH, 2-1/2" CASTOR, W/SILVER FRAME	USED BEFORE ~8/2000. BETWEEN 8/2000 & 3/2001 COULD USE EITHER THE 830272 WRENCH OR THE 8730271 WRENCH.
830263	WRENCH, 2-1/2", 4", 5" CASTOR	FOR 8 SIDED NUT ON UNDERSIDE OF HOUSING. CURRENT PRODUCTION.
872904	WRENCH, DOOR HINGE, TORSION SPRING	THIS IS A NO CHARGE ITEM

T-49G 115v w/Suggested spare parts

Suggested Spare Parts		
Part #	Description	CS Info
866743	ACCUMULATOR	
929778	BACKSCREEN KIT, BLACK ALUMINUM	PERFORATED METAL THAT COVERS COMPRESSOR AREA IN REAR OF CABINET TO PREVENT ACCESS.
800506	BALLAST, LIGHT, 115V, NON-IDL	
914241	BALLAST, LIGHT, 115V/208V, DOOR, IDL,	USE AFTER 11/28/00 PRODUCTION DATE. REPLACES 800542 & 800559
861074	BASE, COMPRESSOR, METAL PLATFORM	
861301	BASE, GASKET, PERIMETER STAINLESS, VERTICAL CENTER MULLION	LOCATED ON CABINET BETWEEN THE DOORS
841477	BASE, LAMPHOLDER/ LAMPSHIELD, IDL DOOR	IF COOLER WAS PRODUCED BEFORE 12/99 PRODUCTION DATE NEW SCREW HOLES MAY HAVE TO BE DRILLED AS THIS BASE HAS A DIFFERENT SCREW HOLE CONFIGURATION.
832056	BASKET, NOVELTY, WHITE, 19 1/4"W X 17 1/8"D	MUST SET ON SHELF
832055	BASKET, NOVELTY, WHITE, 19-1/4"W X 22"D	SETS ON A SHELF. 3 DIVIDERS INCLUDED.
832109	BEARING, THRUST, DOOR HINGE	
801006	BLADE, FAN MOTOR, CONDENSER	
861106	BLADE, FAN MOTOR, EVAPORATOR	
801030	BLADE, FAN MOTOR, EVAPORATOR, 115V FOR EMBRACO SYSTEM	**NOTE FACTORY DATES: USED AFTER 11/8/05 PRODUCTION OR SERIAL NO. 1-4310405 FOR PACIFIC PRODUCTION. USED AFTER 11/20/05 PRODUCTION DATE OR SERIAL NO. 1-43101879FOR BOWLING GREEN PRODUCTION.
924848	BLOCK ASSEMBLY, BOTTOM DOOR HINGE	USED BEFORE 7/29/09 (PCN #4283) W/ TORSION SPRING
801452	BLOCK, COMPRESSOR MOUNTING	
832319	BLOCK, DOOR HINGE, BOTTOM	USED AFTER 7/28/09 (PCN #4283) W/ CARTRIDGE HINGE SPRING
832126	BLOCK, DOOR HINGE, TOP	USED BEFORE 7/29/09 (PCN #4283) W/ TORSION SPRING
914647	BRACKET KIT, GRILL MOUNTING EURO ROUNDED FRONT	THIS KIT WILL REPLACE THE PLASTIC FASTENERS USED BEFORE WHEN PLASTIC FASTENERS ARE REMOVED FROM BACKSIDE OF GRILL. USED BEFORE MAGNETIC GRILLS.
913700	BRACKET KIT, GRILL MOUNTING EURO ROUNDED FRONT	USED BEFORE MAGNETIC GRILLS.
928725	BRACKET KIT, GRILL T-49, TS-53 FOR MAGNETIC GRILLS	
864487	BRACKET, BACKSCREEN, MIDDLE FOR POWER CORD, BLACK	REQUIRES 1 PER CABINET.
862690	BRACKET, CENTER DOOR SUPPORT	USED ONLY WHEN ALL DOORS HINGED RIGHT OR ALL LEFT
863642	BRACKET, DOOR SUPPORT (CRATING)	
865417	BRACKET, FAN MOTOR, CONDENSER	
863476	BRACKET, FAN MOTOR, EVAPORATOR, SHALLOW, 115V	115V**NOTE FACTORY DATES: USED AFTER 11/8/05 PRODUCTION OR SERIAL NO. 1-4310405 FOR PACIFIC PRODUCTION. USED AFTER 11/20/05 PRODUCTION DATE OR SERIAL NO. 1-43101879FOR BOWLING GREEN PRODUCTION.
830185	BRACKET, SHELF STANDARD, BOTTOM MOLDED PLASTIC	REPLACES THE METAL L BRACKET USED BEFORE 4/97 AND MOLDED BRACKET USED FOR 4/97 - 6/02 .
862451	BRACKET, SHELF STANDARD, TOP	USED AFTER OCTOBER 1999. HAS WIDE I BEAM CUTOUT. REPLACES BRACKET PREVIOUSLY USED W/ NARROW CUTOUT.
914706	BRACKET, START CAPACITOR, 1/2HP, NEK6212Z, 115V	
914705	CAP, START CAPACITOR	USED W/ NEK6212Z COMPRESSOR
947400	CAPACITOR, START, 115V 60HZ, R134A, 1/2HP	**NOTE FACTORY DATES: USED AFTER 11/8/05 PRODUCTION OR SERIAL NO. 1-4310405 FOR PACIFIC PRODUCTION. USED AFTER 11/20/05 PRODUCTION DATE OR SERIAL NO. 1-43101879FOR BOWLING GREEN
911444	CAPACITOR, START, 115V 60 HZ R-134A 1/2HP FOR EMBRACO COMPRESSOR	USED AFTER 11/8/05 OR APPROX, SERIAL NO. 1-4317432
851134	CAPILLARY TUBE, R-134A	
872010	CASTOR KIT, FRAMED, SET/4	(OPTION) 4" CASTORS W/ 27" FRAMES RAISES CABINET ~4 7/8"
872063	CASTOR KIT, FRAMED, SET/4	(OPTION) 3" CASTORS W/ 27" FRAMES RAISES CABINET ~3 3/4"
879281	CASTOR KIT, FRAMED, SET/4	(OPTION) 2 1/2" CASTORS W/ 27" FRAMES RAISES CABINET ~3 1/2"
830280	CASTOR, SET/4, 2-1/2" 1/2" STEM	OPTION. SILVER HOUSING. USE FOR SER. NO.(1- 793556 - 1005582) (1-1088851 & AFTER)

T-49G 115v w/Suggested spare parts

830277	CASTOR, SET/4, 4", 1/2" STEM	STANDARD CASTOR. FOR SER. NO. (1- 793556 - 1005582) (1-1088801 & AFTER).
861942	CLAMP, COMPRESSOR	
920158	CLIP KIT, SHELF (SET/4)	
909188	CLIP, EUROPEAN GRILL	
918740	CLIP, OVERLOAD MOUNTING	*USED AFTER 6/5/06 PRODUCTION DATE OR APPROX SERIAL NO. 1-4379187 IN MEX...OR AFTER 6/21/06 PRODUCTION DATE OR APPROX SERIAL NO. 1-4531945 FOR BLDG. 8.
831600	CLIP, SHELF	Requires 4 per shelf
830301	CLIP, SHROUD, CONDENSER COIL	REQUIRES 2
922914	CLIP, THERMOMETER SLEEVE	USED TO MOUNT DISPLAY PROBE. PCN 3866
800601	COIL, CONDENSER	
916437	COIL, EVAPORATOR ASSEMBLY (REPLACES THE 800201 PREVIOUSLY USED)	**115V NOTE FACTORY DATES: USED BEFORE 11/9/05 PRODUCTION OR SERIAL NO. 1-4310406 FOR PACIFIC PRODUCTION. USED BEFORE 11/21/05 PRODUCTION DATE OR SERIAL NO. 1-4310180 FOR BOWLING GREEN PRODUCTION. STILL USED ON OTHER VOLTAGES.
916434	COIL, EVAPORATOR ASSEMBLY 115V EMBRACO SYSTEM	USED AFTER 11/8/2005 FOR PACIFIC PRODUCTION & USED AFTER 11/20/2005 FOR BOWLING GREEN PRODUCTION.
842509	COMPRESSOR, 115V 60HZ, R-134A 1/2HP EMBRACO	**NOTE FACTORY DATES: USED AFTER 11/8/05 PRODUCTION OR SERIAL NO. 1-4310405 FOR PACIFIC PRODUCTION. USED AFTER 11/20/05 PRODUCTION DATE OR SERIAL NO. 1-43101879FOR BOWLING GREEN
884939	CONDENSING UNIT, 115V 60HZ, R134A 1/2HP	**NOTE FACTORY DATES: USED AFTER 11/8/05 PRODUCTION OR SERIAL NO. 1-4310405 FOR PACIFIC PRODUCTION. USED AFTER 11/20/05 PRODUCTION DATE OR SERIAL NO. 1-43101879FOR BOWLING GREEN
802179	CONNECTOR, TERMINAL, TEMPERATURE CONTROL, BLUE	
831932	CONTROL, TEMPERATURE, 115V/208V/220V CE	
922814	COPPER REDUCER 1/2 TO 3/8" FOR SUCTION LINE TO PULLOUT	
937374	CORD KIT, 115V EMBRACO COMPRESSOR POWER CORD/CORD KIT	8 PIN AMP CONNECTOR FOR COMPRESSOR POWER CORD AND CORD KIT W/ 8 PIN CONNECTOR THAT CONNECTS START COMPONENTS TO COMPRESSOR POWER CORD
917607	CORD KIT, 115V EMBRACO FROM COMPRESSOR POWER CORD TO START COMPONENTS	USED W/ EMBRACO COMPRESSORS
915105	CORD, CONNECTS START COMPONENTS TO COMPRESSOR POWER CORD	REPLACE W/ 917607 CORD KIT
801797	CORD, POWER, COMPRESSOR, 115V FOR EMBRACO COMPRESSOR ONLY	*NOTE FACTORY DATES: USED AFTER 11/8/05 PRODUCTION OR SERIAL NO. 1-4310405 FOR PACIFIC PRODUCTION. USED AFTER 11/21/05 PRODUCTION DATE OR SERIAL NO. 1-4310180 FOR BOWLING GREEN PRODUCTION.
801732	CORD, POWER, DOOR, "Y", IDL	
801704	CORD, POWER, MAIN, 115V , 15 AMP/WIRE HARNESS/OUTLET/RECEPTACLE, 92"	FOR REPLACEMENT ONLY
801701	CORD, POWER, MAIN, 115V, 108"	
801766	CORD, POWER, MAIN, 115V, 132" (11 FOOT), SPECIAL APPLICATION	CAN BE USED WHENEVER CUSTOMER NEEDS LONGER CORD.
860540	COVER, BALLAST BOX, 115V	
892621	COVER, CAPILLARY SUCTION LINE, STAINLESS, RADIUS TANK	
865450	COVER, CAPILLARY SUCTION LINE, WHITE, RADIUS TANK	
842494	COVER, COMPRESSOR START COMPONENT	
914717	COVER, COMPRESSOR START COMPONENT	USED W/ NEK6212Z COMPRESSOR
860078	COVER, EVAP FAN MOTOR BLADE WHITE ALUMINUM (GUARD)	
860075	COVER, EVAP FAN MOTOR BLADE WHITE ALUMINUM (GUARD), 115V	**NOTE FACTORY DATES: USED AFTER 11/8/05 PRODUCTION OR SERIAL NO. 1-4310405 FOR PACIFIC PRODUCTION. USED AFTER 11/20/05 PRODUCTION DATE OR SERIAL NO. 1-43101879FOR BOWLING GREEN
911436	COVER, TEMPERATURE CONTROL, WHITE(USED FOR ELECTRONIC CONTROL)	USED TO COVER HOLE IN EVAPORATOR HOUSING. ELECTRONIC CONTROL IS MOUNTED IN RAINSHIELD. USED BY VRESSO BEBANON
894755	COVER, TEMPERATURE CONTROL/LIGHT SWITCH CLEAR ALUMINUM FOR GE CONTROL	USED W/ 831932 GE CONTROL (PCN #2943)
894753	COVER, TEMPERATURE CONTROL/LIGHT SWITCH WHITE ALUMINUM FOR GE CONTROL	USED W/ 831932 GE CONTROL (PCN #2943)

T-49G 115v w/Suggested spare parts

890104	COVER, TEMPERATURE CONTROL/LIGHT SWITCH, WHITE	HAS V SHAPED NOTCH TO SET TEMPERATURE.
880251	CROSS BAR, BUN TRAY RACK, 18-3/16"	FOR BUN TRAY RACK 20 7/8"W X 24"D
938752	DIGITAL VACUUM GAUGE, DIGITAL	
910448	DIVIDER ASSEMBLY, NOVELTY BASKET, LARGE, WHITE	USED W/ 832055 BASKET
832057	DIVIDER, NOVELTY BASKET, SMALL, WHITE	FOR SMALL BASKET PART NO. 832056
933711	DOOR, LEFT HINGED, SILVER FRAMED, 115V/208V, WDG, IDL, CARTRIDGE SPRING	STARTED USING CARTRIDGE SPRINGS AFTER 8/12/2009 (PCN #4283) REPLACES/RETROFITS TORSION SPRING DOORS USED PRIOR.
870668	DOOR, LEFT HINGED, SILVER FRAMED, NON-IDL	
933712	DOOR, RIGHT HINGED, SILVER FRAMED, 115V/208V, WDG, IDL, CARTRIDGE SPRING	STARTED USING CARTRIDGE SPRINGS AFTER 8/12/2009 (PCN #4283) REPLACES/RETROFITS TORSION SPRING DOORS USED PRIOR.
870667	DOOR, RIGHT HINGED, SILVER FRAMED, NON-IDL	
925928	DRIER, COMPRESSOR, 115V	115V ONLY REPLACES ALL THE 800801 PREVIOUSLY USED. STARTED TO USE IN PRODUCTION AFTER 5/23/11 PRODUCTION DATE OR SER. NO 1-7146849 PER PCN 5043
831998	FACEPLATE, THERMOMETER, CELCIUS, DIXEL X420C ()	
810719	GASKET, DOOR, MAGNETIC (NWDG)	USED AFTER 9/01/2009 (PCN #4106)
912382	GLASS INSERT, DOOR, IDL	
912290	GLASS INSERT, DOOR, NON-IDL	
928694	GRILL KIT, ALL LEFT HINGE, MAGNETIC WITH MOUNTING BRACKETS	USED TO RETROFIT OLDER STYLE GRILLS USED BEFORE 1/6/2009 (PCN #4115)
928693	GRILL KIT, ALL RIGHT HINGE, MAGNETIC WITH MOUNTING BRACKETS	USED TO RETROFIT OLDER STYLE GRILLS USED BEFORE 1/6/2009 (PCN #4115)
928695	GRILL KIT, RIGHT HINGE/LEFT HINGE, MAGNETIC WITH MOUNTING BRACKETS	USED TO RETROFIT OLDER STYLE GRILLS USED BEFORE 1/6/2009 (PCN #4115)
928665	GRILL, ASSEMBLY, STAINLESS, ALL LEFT HINGE, ROUNDED, MAGNETIC	GRILL IS ROUNDED AND MOUNTING IS MAGNETIC. USE KIT TO RETROFIT OLD STYLE GRILLS.. PCN 4115
928664	GRILL, ASSEMBLY, STAINLESS, ALL RIGHT HINGE, ROUNDED, MAGNETIC	GRILL IS ROUNDED AND MOUNTING IS MAGNETIC. USE KIT TO RETROFIT OLD STYLE GRILLS.. PCN 4115
928666	GRILL, ASSEMBLY, STAINLESS, LEFT HINGE/RIGHT HINGE, ROUNDED, MAGNETIC	GRILL IS ROUNDED AND MOUNTING IS MAGNETIC. USE KIT TO RETROFIT OLD STYLE GRILLS.. PCN 4115
810203	GROMMET, DRAIN ELBOW	SERVES AS A PROTECTION ONLY AROUND HOLE CUT IN EVAPORATOR HOUSING FOR DRAIN ELBOW. DOES NOT SERVE AS A WASHER FOR SEALING DRAIN ELBOW.
879473	HANDLE KIT, DOOR, BLACK	HOLES DRILLED ON HANDLE AND DOOR 8-1/8" APART
851217	HANDLE, DOOR, SILVER, GLASS DOORS	HOLES DRILLED ON HANDLE AND DOOR 8-1/8" APART. USED ON GLASS DOORS.
928642	HEATER KIT, CONDENSATE PAN	USED FOR FIELD INSTALL. 927642 HEATED DRAIN PAN SITS INSIDE OF 912540 METAL PAN. (FT #2388)
927642	HEATER, CONDENSATE DRAIN PAN, 115V/160W W/5-15 CORD (FOR FIELD INSTALL)	USED FOR FIELD INSTALL. SITS IN METAL DRAIN PAN ORDER SEPARTELY
801814	HEATER, CONDENSATE PAN, 115V, ONE-PIECE PAN/HEATER	ONLY USED TO REPLACE AN EXISTING 801814-FI HEATED DRAIN PAN. NEW INSTALLATION IN FIELD VOIDS UL APPROVAL.
801801	HEATER, DOOR MULLION, 115V	
933106	HINGE KIT, DOOR, BOTTOM LEFT OR RIGHT	REPLACES/RETROFITS 870866 PREVIOUSLY USED (FT #2725)
933800	HINGE KIT, DOOR, TOP, LEFT, CARTRIDGE HINGE	USED AFTER 8/12/2009 (PCN #4283)
933799	HINGE KIT, DOOR, TOP, RIGHT, CARTRIDGE HINGE	USED AFTER 8/12/2009 (PCN #4283)
862006	HOLDER, CONDENSATE DRAIN PAN WICKING PAD, CLEAR ALUMINUM	
882671	HOSE, EVAPORATOR DRAIN	
928718	INSTRUCTION, INSTALLATION T-SE GRILL RETROFIT TO MAGNETIC	
820746	INSULATION, DRAIN PAN, EVAPORATOR	
831306	KEY, LOCK, DOOR	USED BEFORE 1/6/2009 W/ 831357 LOCK ASSEMBLY
932992	KEY, LOCK, DOOR	USED AFTER 1/5/2009 W/ 831373 LOCK ASSEMBLY
873054	KIT, GASKET BASE, PERIMETER PLASTIC	LOCATED ON CABINET "NOT ON DOOR". SURROUNDS DOOR OPENING. THIS PIECE HOLDS PERIMETER STAINLESS (AND PERIMETER HEATER WIRE ON SOME MODELS). 4 PIECE ASSEMBLY.

T-49G 115v w/Suggested spare parts

874707	KIT, GASKET BASE, PERIMETER STAINLESS	LOCATED ON CABINET "NOT ON DOOR". SURROUNDS DOOR OPENING. INSERTS INTO PERIMETER PLASTIC. 4 PIECE ASSEMBLY.
918741	KIT, OVERLOAD/BACKET, 115V 60 HZ R-134A, 1/3HP, FOR EMBRACO COMPRESSOR	*USED AFTER 6/5/06 PRODUCTION DATE OR APPROX SERIAL NO. 1-4379187 IN MEX...OR AFTER 6/21/06 PRODUCTION DATE OR APPROX SERIAL NO. 1-4531945 FOR BLDG. 8.
913366	KIT, START COMPONET FOR EMBRACO	**NOTE FACTORY DATES: USED AFTER 11/8/05 PRODUCTION OR SERIAL NO. 1-4310405 FOR PACIFIC PRODUCTION. USED AFTER 11/20/05 PRODUCTION DATE OR SERIAL NO. 1-43101879FOR BOWLING GREEN PRODUCTION.
880982	KNOB, TEMPERATURE CONTROL, DANFOSS	
831935	KNOB, TEMPERATURE CONTROL, GE	
875548	KNOB, TEMPERATURE CONTROL, RANCO/CUTLER HAMMER	
801155	LAMP, 115V/208V, IDL, T-8 24K	USED AFTER 11/28/00 PRODUCTION DATE OR AFTER APPROX. SER. NO. 1-2786221
801101	LAMP, 115V/208V, NON-IDL, T-12	
801223	LAMPHOLDER, 115V/208V, NON-IDL	
801224	LAMPHOLDER, 115V/208V, NON-IDL	
801254	LAMPHOLDER, 115V/208V/220V, DOOR, IDL "BOTTOM"	FOR ALL EXCEPT FROM 12/99 TO 12/8/00 PRODUCTION.
842111	LAMPHOLDER, 115V/208V/220V/CE, IDL DOOR	115V/208V/220V USED FROM 12/99 - 12/8/01 PRODUCTION. 220V CE STILL USED FOR BOTTOM OR TOP OF DOOR.
801253	LAMPSHIELD END CAP, T12 LAMP, NON-IDL	
810873	LAMPSHIELD, DOOR, 115V/208V/220V & CE, IDL	
801206	LAMPSHIELD, T12 LAMP, NON-IDL	
872001	LEG KIT, 6" , SET/4, FRAME STYLE	OPTIONAL ANY SERIAL NUMBER
880348	LEG KIT, 6" SET/4, 1/2" DIA. STEM, SEISMIC	OPTION
872025	LEG KIT, 6", SET/4, 1/2" DIA. STEM	USED AFTER SER. NO. 1-793556 EXCEPT FOR (1-1005583 - 1-1088848)
871016	LIGHT ASSEMBLY, 115V/208V, INTERIOR, NON-IDL	
871047	LIGHT ASSEMBLY, 115V/208V/220V, LEFT HINGED, IDL DOOR, BLACK	
871035	LIGHT ASSEMBLY, 115V/208V/220V, RIGHT HINGED, IDL DOOR, BLACK	
920406	LIGHT ASSEMBLY, 115V/208V/220V, RIGHT HINGED, IDL DOOR, SILVER	
910802	LINE SET, ACCUMULATOR/CAPILLARY TUBE/SUCTION LINE, R-134A EMBRACO	**NOTE FACTORY DATES: USED AFTER 11/8/05 PRODUCTION OR SERIAL NO. 1-4310405 FOR PACIFIC PRODUCTION. USED AFTER 11/20/05 PRODUCTION DATE OR SERIAL NO. 1-43101879FOR BOWLING GREEN
831373	LOCK, DOOR, GLASS (ONE PER DOOR)	STARTED USING ON 1/6/2009. REPLACES/RETROFITS PREVIOUS (872837) LOCK ASSEMBLY. (PCN #4115)
926534	MAGNETIC CATCH, GRILL	
800439	MOTOR, CONDENSER FAN, 115V 60HZ, FOR EMBRACO COMPRESSOR	**NOTE FACTORY DATES: USED AFTER 11/8/05 PRODUCTION OR SERIAL NO. 1-4310405 FOR PACIFIC PRODUCTION. USED AFTER 11/20/05 PRODUCTION DATE OR SERIAL NO. 1-43101879FOR BOWLING GREEN
922036	MOTOR, EVAPORATOR FAN	USED AFTER 3/19/08 PRODUCTION DATE. REPLACES THE 800437 PREVIOUSLY USED. PCN #3968
800437	MOTOR, EVAPORATOR FAN, 115V FOR EMBRACO SYSTEM	**NOTE FACTORY DATES: USED AFTER 11/8/05 PRODUCTION OR SERIAL NO. 1-4310405 FOR PACIFIC PRODUCTION. USED AFTER 11/20/05 PRODUCTION DATE OR SERIAL NO. 1-43101879FOR BOWLING GREEN
872926	MULLION ASSEMBLY, VERTICAL, NON-IDL	
820344	NAMEPLATE, TRUE	
811502	NOZZLE, EVAPORATOR DRAIN, PLASTIC, WHITE (45 DEGREE ELBOW)	
830931	NUT, SHELF STANDARD	
801229	OUTLET/RECEPTACLE, COMPRESSOR POWER CORD, 115V/208V/220V NON CE	
947399	OVERLOAD, 115V 60 HZ R-134A 1/2 HP	**NOTE FACTORY DATES: USED AFTER 11/8/05 PRODUCTION OR SERIAL NO. 1-4310405 FOR PACIFIC PRODUCTION. USED AFTER 11/20/05 PRODUCTION DATE OR SERIAL NO. 1-43101879FOR BOWLING GREEN

T-49G 115v w/Suggested spare parts

842474	OVERLOAD, 115V 60 HZ R-134A, 1/3HP, FOR EMBRACO COMPRESSOR	*USED AFTER 6/5/06 PRODUCTION DATE OR APPROX SERIAL NO. 1-4379187 IN MEX...OR AFTER 6/21/06 PRODUCTION DATE OR APPROX SERIAL NO. 1-4531945 FOR BLDG. 8.
831920	PAD, WICKING	REQUIRES 5 TOTAL PADS
874655	PAD, WICKING (SET OF 5)	
891858	PAN, DRAIN, CONDENSATE, BOTTOM, METAL, OPTION	
912540	PAN, DRAIN, CONDENSATE, BOTTOM, METAL, WITH HOLE OPTION	USE WITH ONE PIECE-DRAIN PAN HEATER
810231	PAN, DRAIN, CONDENSATE, BOTTOM, PLASTIC	
871202	PAN, DRAIN, EVAPORATOR	
832103	PIN, STOP, DOOR HINGE	USED BEFORE 7/29/09 (PCN #4283) W/ TORSION SPRING
935910	PROBE, THERMOMETER	USED W/ 800400 THERMOMETER
874525	PULLOUT ASSEMBLY, COMPRESSOR	115V REPLACE WITH 953081 PULLOUT. 208V/220 THIS PART IS STILL USED.
871729	RACK, BUN TRAY, FULL DOOR	FOR 18"(46CM) X 26"(66CM) SHEET PANS. COMES WITH 44 PAN SUPPORTS TO HOLD 22 PANS. MAXIMUM CAPACITY IS 32 PANS. SPACING OF NOTCHES ON VERTICAL SIDES OF RACK ARE 1-1/2" APART.
871728	RACK, BUN TRAY, HALF DOOR	FOR 18" X 26" PAN COMES WITH 22 PAN SUPPORTS TO HOLD 11 PANS. MAXIMUM CAPACITY IS 13 BUN PANS.
871573	RAINSHIELD, FOR ALL DOORS HINGED RIGHT	
871557	RAINSHIELD, FOR STANDARD HINGED DOORS 1 LEFT/1 RIGHT	
878038	RECEPTACLE, POWER CORD, DOOR, IDL	USED AFTER 12/4/00 PRODUCTION DATE. LOCATED IN BALLAST BOX. CONNECTS SPLIT "Y" DOOR LIGHT POWER CORD TO BALLAST.
947398	RELAY, 115V 60HZ R-134A	**NOTE FACTORY DATES: USED AFTER 11/8/05 PRODUCTION OR SERIAL NO. 1-4310405 FOR PACIFIC PRODUCTION. USED AFTER 11/20/05 PRODUCTION DATE OR SERIAL NO. 1-43101879FOR BOWLING GREEN PRODUCTION.
842463	RELAY, 115V 60HZ R-134A 1/2HP, EMBRACO	**NOTE FACTORY DATES: USED AFTER 11/8/05 PRODUCTION OR SERIAL NO. 1-4310405 FOR PACIFIC PRODUCTION. USED AFTER 11/20/05 PRODUCTION DATE OR SERIAL NO. 1-43101879FOR BOWLING GREEN
800182	RELAY, TEMPERATURE CONTROL	FOR DANFOSS 077B7633 CONTROL
873008	RETAINER KIT, DOOR GASKET, NARROW GASKET	USED BEFORE 3/29/2007 W/ 810803 GASKET.
934074	RETAINER KIT, DOOR GASKET, NWDG	USED AFTER 9/01/2009 (PCN #4106) W/ 810719 GASKET. THIS IS THE BLACK PLASTIC ON THE DOOR THAT HOLDS THE GASKET IN PLACE. CONSISTS OF 4 PIECES AND WILL RETROFIT OLDER STYLE DOORS IF THE GASKET IS ALSO REPLACED.
874654	RIVNUT TOOL, CASTOR OR LEG, 1/2" STEM	
874642	RIVNUT TOOL, KIT, SHELF STANDARD	
874640	RIVNUT TOOL, SHELF STANDARD	
830926	RIVNUT, CASTOR OR LEG, 1/2" STEM	
830909	RIVNUT, SHELF STANDARD	
861087	SCREEN, CONDENSER FAN MOTOR	
832108	SHAFT, DOOR HINGE	USED BEFORE 8/13/2009 (PCN #4283) W/ TORSION SPRING DOORS
929905	SHAFT, DOOR HINGE TOP, FOR 928370 CARTRIDGE HINGE	USED AFTER 8/12/2009 (PCN #4283) W/ CARTRIDGE SPRING DOORS
917307	SHELF KIT, CHROME WIRE	
871719	SHELF KIT, STAINLESS STEEL	<<POSSIBLE 3-4 WEEK LEAD TIME DUE TO ELECTRO POLISHING>>
875378	SHELF KIT, WHITE WIRE, FOR TRAY CHANNEL	UK DESIGN (GASTRONORM)
871781	SHELF KIT, WHITE WIRE, IDL	
871791	SHELF KIT, WHITE WIRE, NON-IDL	
861105	SHELF STANDARD, 47 3/8", CABINET SIDE, WHITE	STANDARD PRODUCTION
832195	SHELF STANDARD, 52", CABINET SIDE, STAINLESS STEEL	(OPTION) INCLUDE: 9)830501 MOUNTING SCREWS
879490	SHELF STANDARD, BACK CENTER, SILVER	
871807	SHELF STANDARD, BACK CENTER, WHITE	
872974	SHELF STANDARD, CABINET SIDE, WHITE, 52", OPTION	
871801	SHELF STANDARD, FRONT CENTER, SILVER	

T-49G 115v w/Suggested spare parts

871803	SHELF STANDARD, FRONT CENTER, WHITE	
801501	SHROUD, CONDENSER COIL	
801504	SHROUD, CONDENSER FAN MOTOR & BLADE	GOES OVER TOP CONDENSER SCREEN TO PROTECT HANDS FROM GOING INTO FAN AREA
867770	SLEEVE, TEMPERATURE CONTROL	
832320	SLEEVE, THERMOMETER	USED ONLY WITH LED TEMPERATURE DISPLAY. ONLY THE DISPLAY PROBE IS IN BRASS SLEEVE AND WRAPPED IN CORK TAPE PER PCN 3866
871754	SLIDE, BUN TRAY RACK, STANDARD	STANDARD RAILS THAT COME WITH THE BUN TRAY RACKS.
875543	SPACER KIT, DOOR HANDLE, SILVER	
875587	SPRING, HINGE, DOOR	USED BEFORE 8/13/2009 (PCN #4283) AFTER THIS DATE DOORS ARE FITTED W/ CARTRIDGE SPRINGS
928369	SPRING, HINGE, DOOR, TOP, LEFT HINGE, CARTRIDGE	USED AFTER 8/12/2009 (PCN #4283)
928370	SPRING, HINGE, DOOR, TOP, RIGHT HINGE, CARTRIDGE	USED AFTER 8/12/2009 (PCN #4283)
830170	STAND OFF, SHELF	PCN5328
953050	STRIKER, ROCKER SWITCH KIT	REPLACES 875510 PER PCN 5050 8/1/2011 OR SERIAL NO 1-7198578
953404	SWITCH, LIGHT, TOGGLE STYLE	
801924	SWITCH, POWER, 115V	TO SHUT OFF POWER TO SERVICE.
820204	TAPE, LIGHT, FILLER CHANNEL, IDL	SILVER ALUMINUM
925507	THERMOMETER, DIAL, CELCIUS/FAHRENHEIT, ROUND EXTERIOR, BLACK FACED, STANDARD	REPLACES 831914 PREVIOUSLY USED (PCN #4115)
830426	THERMOMETER, DIAL, CELCIUS/FAHRENHEIT, ROUND INTERIOR HANGING	OPTION
822205	THERMOMETER, DIGITAL, CELCIUS, LED, 115V ROUND EXTERIOR,	WITH BUILT IN TRANSFORMER
831904	THERMOMETER, DIGITAL, CELSIUS, LED	REQUIRES TRANSFORMER. IN PRODUCTION THIS WAS USED BEFORE 6/25/03. WHEN WE RUN OUT OF THESE THE 831930-FI CAN BE SENT AS A REPLACEMENT
831908	THERMOMETER, DIGITAL, FAHRENHEIT, EXTERIOR	OPTION
800400	THERMOMETER, DIGITAL, FAHRENHEIT, LED, 115V, ROUND EXTERIOR	OPTION
800321	THERMOMETER, FAHRENHEIT/CELSIUS, TUBE TYPE	
863105	TIMER BOX	
832270	TOOL, ADJUSTMENT, DANFOSS TEMPERATURE CONTROL	USED TO CALIBRATED DANFOSS CONTROL
831970	TRANSFORMER, THERMOMETER, 115V	REPLACES 831909 MODEL 015-0054-01
921754	TRIM, IDL GRILL, BLACK	USED AFTER 10/13/08 PRODUCTION DATE . WILL RETROFIT. . BLACK PLASTIC TRIM THAT GOES AROUND THE CUTOUT IN THE GRILL. THIS WILL HELP PROTECT THE DOOR CORD. PER FT 4101
820799	WICKING KIT, CONDENSATE PAN	OPTION.
879202	WINE RACK KIT, BLACK	MAXIMUM NUMBER OF RACKS PER DOOR IS 8 USING NO SHELF AND FOR SMALL DIAMETER BOTTLES. FOR LARGER BOTTLES. 5 - 6 RACKS PER DOOR IS SUGGESTED. 10 AVERAGE SIZED BOTTLES FIT PER RACK.
830263	WRENCH, 2-1/2", 4", 5" CASTOR	FOR 8 SIDED NUT ON UNDERSIDE OF HOUSING. CURRENT PRODUCTION.
872904	WRENCH, DOOR HINGE, TORSION SPRING	THIS IS A NO CHARGE ITEM