

CONGRATULATIONS!

You have just purchased the finest commercial refrigerator available. You can expect many years of trouble-free operation.

TABLE OF CONTENTS

SAFETY INFORMATION

Safety Precautions _____ 1
Proper Disposal, Connecting Electricity, & Adapter Plugs _____ 2

INSTALLATION

Ownership, Uncrating, & How to Connect to Electricity _____ 3
Wire Gauge Chart _____ 4
Locating and Leveling _____ 5
Installation of Castors _____ 6
Sealing Cabinet to the Floor _____ 6

SETUP

Standard Accessories _____ 7

OPERATION

Startup _____ 10
Mechanical Temperature Controls Sequence of Operation _____ 11

MAINTENANCE, CARE, CLEANING

Cleaning Condenser Coil _____ 15
Important Warranty Information _____ 16
Stainless Steel Equipment Care and Cleaning _____ 17
General Maintenance _____ 18

WARRANTY

Warranty _____ 19

**CURVED GLASS DISPLAY CASES
REFRIGERATED BAKERY,
DRY BAKERY, DUAL ZONE
& COLD DELI**



TCGD-36



TCGDZ-50



TCGR-77



INSTALLATION MANUAL

TCGR: CURVED GLASS DISPLAY CASES



NOTICE TO CUSTOMER

Loss or spoilage of products in your refrigerator/freezer is not covered by warranty. In addition to following recommended installation procedures you must run the refrigerator/freezer 24 hours prior to usage.



SAFETY INFORMATION

How to Maintain Your True Refrigerator to Receive the Most Efficient and Successful Operation.

You have selected one of the finest commercial refrigeration units made. It is manufactured under strict quality controls with only the best quality materials available. Your TRUE cooler when properly maintained will give you many years of trouble-free service.

WARNING: Use this appliance for its intended purpose as described in this Owner Manual.

TO LOCATE REFRIGERANT TYPE, SEE SERIAL LABEL INSIDE CABINET. This cabinet may contain fluorinated greenhouse gas covered by the Kyoto Protocol (please refer to cabinet's inner label for type and volume, GWP of 134a= 1,300. R404a= 3,800).

FOR HYDROCARBON REFRIGERATION ONLY (R-290) SEE BELOW:

- **DANGER** - Risk of fire or explosion. Flammable refrigerant used. Do not use mechanical devices to defrost refrigerator. Do not puncture refrigerant tubing.
- **DANGER** - Risk of fire or explosion. Flammable refrigerant used. To be repaired only by trained service personnel. Do not puncture refrigerant tubing.
- **CAUTION** - Risk of fire or explosion. Flammable refrigerant used. Consult repair manual/owner's guide before attempting to service this product. All safety precautions must be followed.
- **CAUTION** - Risk of fire or explosion. Dispose of properly in accordance with federal or local regulations. Flammable refrigerant used.
- **CAUTION** - Risk of fire or explosion due to puncture of refrigerant tubing; follow handling instructions carefully. Flammable refrigerant used.
- **CAUTION** - Keep clear of obstruction all ventilation openings in the appliance enclosure or in the structure for building-in.

SAFETY PRECAUTIONS

When using electrical appliances, basic safety precautions should be followed, including the following:

- This refrigerator must be properly installed and located in accordance with the Installation Instructions before it is used.
- Do not allow children to climb, stand or hang on the shelves in the refrigerator. They could damage the refrigerator and seriously injure themselves.
- Do not touch the cold surfaces in the freezer compartment when hands are damp or wet. Skin may stick to these extremely cold surfaces.
- Do not store or use gasoline or other flammable vapors and liquids in the vicinity of this or any other appliance. Do not store explosive substances such as aerosol cans with a flammable propellant in this appliance.

- Keep fingers out of the "pinch point" areas; clearances between the doors and between the doors and cabinet are necessarily small; be careful closing doors when children are in the area.
- Unplug the refrigerator before cleaning and making repairs.
- Setting temperature controls to the 0 position does not remove power to the light circuit, perimeter heaters, or evaporator fans.

NOTE: We strongly recommend that any servicing be preformed by a qualified technician.

DANGER

RISK OF CHILD ENTRAPMENT

PROPER DISPOSAL OF THE REFRIGERATOR

Child entrapment and suffocation are not problems of the past. Junked or abandoned refrigerators are still dangerous... even if they will sit for "just a few days." If you are getting rid of your old refrigerator, please follow the instructions below to help prevent accidents.

BEFORE YOU THROW AWAY YOUR OLD REFRIGERATOR OR FREEZER:

- Take off the doors.
- Leave the shelves in place so that children may not easily climb inside.

APPLIANCE DISPOSAL

When recycling appliance please make sure that the refrigerants are handled according to local and national codes, requirements and regulations.

REFRIGERANT DISPOSAL

Your old refrigerator may have a cooling system that uses "Ozone Depleting" chemicals. If you are throwing away your old refrigerator, make sure the refrigerant is removed for proper disposal by a qualified service technician. If you intentionally release any refrigerants you can be subject to fines and imprisonment under provisions of the environmental regulations.

USE OF EXTENSION CORDS

NEVER USE AN EXTENSION CORD! TRUE will not warranty any refrigerator that has been connected to an extension cord.

REPLACEMENT PARTS

- Component parts shall be replaced with like components.
- Servicing shall be done by authorized service personnel, to minimize the risk of possible ignition due to incorrect parts or improper service.
- Lamps must be replaced by identical lamps only.
- If the supply cord is damaged, it must be replaced by a special cord or assembly available from the manufacturer or its service agent.

WARNING!

HOW TO CONNECT ELECTRICITY

FOR MODELS WITH OPTIONAL 12" (30.5 CM) CORD.

The power cord of this appliance is equipped with a grounding plug which mates with a standard grounding wall outlet to minimize the possibility of electric shock hazard from this appliance.

Have the circuit checked by a qualified electrician to make sure it is properly grounded.

USE OF ADAPTER PLUGS

NEVER USE AN ADAPTER PLUG! Because of potential safety hazards under certain conditions, we strongly recommend against the use of an adapter plug.

The incoming power source to the cabinet including any adapters used must have the adequate power available and must be properly grounded. Only adapters listed with UL should be used.

NORTH AMERICA USE ONLY!

NEMA plugs

TRUE uses these types of plugs. If you do not have the right outlet have a certified electrician install the correct power source.

NOTE: International plug configurations vary by voltage and country.



115/60/1
NEMA-5-15R



115/208-230/1
NEMA-14-20R



115/60/1
NEMA-5-20R



208-230/60/1
NEMA-6-15R

INSTALLATION

OWNERSHIP

To ensure that your unit works properly from the first day, it must be installed properly. We highly recommend a trained refrigeration mechanic and electrician install your TRUE equipment. The cost of a professional installation is money well spent.

Before you start to install your TRUE unit, carefully inspect it for freight damage. If damage is discovered, immediately file a claim with the delivery freight carrier.

TRUE is not responsible for damage incurred during shipment.

UNCRATING

TOOLS REQUIRED

- Tin Snips / Band Cutters
- Claw Hammer
- Hex Head Driver
- Adjustable Wrench
- 3/4" (19 mm) Open-End Wrench
- Phillips Screwdriver
- Level

The following procedure is recommended for uncrating the unit:

- A. Cut metal retaining straps securing protective top skid. Remove the outer packaging by pulling tri-wall nails from skid. Remove (4) cardboard corner pads and dust cover.
- B. Inspect for concealed damage. Again, immediately file a claim with the freight carrier if there is damage.
- C. Move your display case as close to the final location as possible before removing the wooden skid.

NOTE: KEYS FOR COOLERS WITH DOOR LOCKS ARE LOCATED IN WARRANTY PACKETS.

ELECTRIC INSTALLATION & SAFETY INFORMATION

Hard wiring for a 30 amp circuit is required on specific Display Cases.¹

Models standard with power cords: Do not, under any circumstances, cut or remove the ground prong from the power cord. For personal safety, this appliance must be properly grounded.

- If the supply cord is damaged, it must be replaced by a special cord or assembly available from the manufacturer or its service agent.
- Lamps must be replaced by identical lamps only.
- Appliance tested according to the climate classes 5 and 7 temperature and relative humidity.

ELECTRICAL INSTRUCTIONS

- A. Before your new unit is connected to a power supply, check the incoming voltage with a voltmeter. If anything less than 100% of the rated voltage for operation is noted, correct immediately.
- B. All units equipped with a service cord must be powered at proper operating voltage at all times. Refer to cabinet data plate for this voltage.

TRUE RECOMMENDS THAT A SOLE USE CIRCUIT BE DEDICATED FOR THE UNIT.

WARNING: Compressor warranties are void if compressor burns out due to low voltage.

WARNING: Power supply cord ground should not be removed!

WARNING: Do not use electrical appliances inside the food storage compartments of the appliances unless they are of the type recommended by the manufacturer.

NOTE: To reference wiring diagram, remove front louvered grill, wiring diagram is positioned on the inside cabinet wall.

CURVED GLASS DISPLAY CASES

Some cases are equipped with a service receptacle, found on the upper right cabinet and backside. No electrical load greater than 4-5 amps should be connected to this receptacle. Maximum Amp load is listed on the label next to the service receptacle.



FOR REFERENCE ONLY

WIRE GAUGE CHART

115 Volts													230 Volts												
Amps	Distance In Feet To Center of Load												Amps	Distance In Feet To Center of Load											
	20	30	40	50	60	70	80	90	100	120	140	160		20	30	40	50	60	70	80	90	100	120	140	160
2	14	14	14	14	14	14	14	14	14	14	14	14	5	14	14	14	14	14	14	14	14	14	14	14	
3	14	14	14	14	14	14	14	14	14	14	14	14	6	14	14	14	14	14	14	14	14	14	14	14	
4	14	14	14	14	14	14	14	14	14	14	14	14	7	14	14	14	14	14	14	14	14	14	14	14	
5	14	14	14	14	14	14	14	14	14	14	14	14	8	14	14	14	14	14	14	14	14	14	14	14	
6	14	14	14	14	14	14	14	14	14	14	14	14	9	14	14	14	14	14	14	14	14	14	14	14	
7	14	14	14	14	14	14	14	14	14	14	14	14	10	14	14	14	14	14	14	14	14	14	14	14	
8	14	14	14	14	14	14	14	14	14	14	14	14	12	14	14	14	14	14	14	14	14	14	14	14	
9	14	14	14	14	14	14	14	14	14	14	14	14	14	14	14	14	14	14	14	14	14	14	14	14	
10	14	14	14	14	14	14	14	14	14	14	14	14	16	14	14	14	14	14	14	14	14	14	14	14	
12	14	14	14	14	14	14	14	14	14	14	14	14	18	14	14	14	14	14	14	14	14	14	14	14	
14	14	14	14	14	14	14	14	14	14	14	14	14	20	14	14	14	14	14	14	14	14	14	14	14	
16	14	14	14	14	14	14	14	14	14	14	14	14	25	14	14	14	14	14	14	14	14	14	14	14	
18	14	14	14	14	14	14	14	14	14	14	14	14	30	14	14	14	14	14	14	14	14	14	14	14	
20	14	14	14	14	14	14	14	14	14	14	14	14	35	14	14	14	14	14	14	14	14	14	14	14	
25	14	14	14	14	14	14	14	14	14	14	14	14	40	14	14	14	14	14	14	14	14	14	14	14	
30	14	14	14	14	14	14	14	14	14	14	14	14	50	14	14	14	14	14	14	14	14	14	14	14	
35	14	14	14	14	14	14	14	14	14	14	14	14	60	14	14	14	14	14	14	14	14	14	14	14	
40	14	14	14	14	14	14	14	14	14	14	14	14	70	14	14	14	14	14	14	14	14	14	14	14	
45	14	14	14	14	14	14	14	14	14	14	14	14	80	14	14	14	14	14	14	14	14	14	14	14	
50	14	14	14	14	14	14	14	14	14	14	14	14	90	14	14	14	14	14	14	14	14	14	14	14	
	14	14	14	14	14	14	14	14	14	14	14	14	100	14	14	14	14	14	14	14	14	14	14	14	

LOCATING

- A. Use a Phillips screw driver and remove four screws from the L-bracket connected the unit to the wood skid (image 1). Then use a 3/8" (9.5 mm) socket or wrench and remove the L-bracket from the unit (image 2).

TO AVOID DAMAGE TO GLASS DO NOT LAY CABINET ON ITS SIDE OR BACK WHEN REMOVING SKID, INSTALLING LEG LEVELERS, CLEANING, ETC.

- B. Lift up from the base and walk unit off the skid and set in final location.
- C. Unblock doors, free plastic wedges, blue foam and tape. Remove fiberglass tape securing glass. Remove components: (shelves, brackets, etc.) from inside cabinet.
- D. Appliance tested according to the climate classes 5 and 7 for temperature and relative humidity.



Removing bracket from skid.

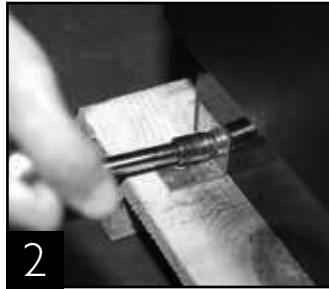

Removing bracket from cabinet.

LEVELING

- A. Set unit in its final location. Be sure there is adequate ventilation in your room. Under extreme heat conditions, (100°F+, 38°C+), you may want to install an exhaust fan.

WARNING: WARRANTY IS VOID IF VENTILATION IS INSUFFICIENT.

- B. Proper leveling of your TRUE unit is critical to operating success (for non-mobile models). Effective condensate removal and door operation will be effected by leveling.

WARNING: DISPLAY CASE MUST BE LEVELED ACCURATELY TO ENSURE FRONT GLASS DOOR SEALS PROPERLY.

- C. The unit should be leveled front to back and side to side with a level. Place the level in the interior floor of the unit and check all four sides.
- D. If the cabinet is not level adjust leg levelers by first relieving weight to leveler and adjusting by either hand or wrench. Repeat with all leg levelers until cabinet is level in all directions.
- E. Ensure that the drain hose or hoses are positioned in the pan.
- F. Models with power cord: Free plug and cord from inside the lower rear of the cooler (do not plug in).
- G. Models with power cord: The unit should be placed close enough to the electrical supply so that extension cords are never used.

WARNING: CABINET WARRANTIES ARE VOID IF OEM POWER CORD IS TAMPERED WITH. TRUE WILL NOT WARRANTY ANY UNITS THAT ARE CONNECTED TO AN EXTENSION CORD.

RECOMMENDED OPERATION CONDITIONS (75°F DEGREES & 55% RELATIVE HUMIDITY)

WARNING: DRY BAKERY CASES REQUIRE HARD WIRING UNLESS ORDERED WITH 12" (30.5 CM) CORD OPTION. CABINET WARRANTIES ARE VOID IF OEM POWER CORD IS TAMPERED WITH. TRUE WILL NOT WARRANTY ANY UNITS THAT ARE CONNECTED TO AN EXTENSION CORD.

INSTALLATION OF CASTORS

TOOLS REQUIRED:

- Castor wrench (if not included contact TRUE)
- Adjustable wrench

NOTE: CASTORS NOT AVAILABLE FOR HARD WIRED MODELS.

WARNING: MAKE SURE UNIT IS EMPTY OF ALL ITS CONTENTS (SHELVING, SHELVING LIGHTING). MAKE SURE POWER SUPPLY HAS BEEN DISCONNECTED.

- Curved glass can be damaged if you lay unit on its back, side, or front. Use a 6" x 6" (15.2 cm x 15.2 cm) block of wood or equivalent. Slide the block under the cabinet frame rail. This will support the unit while installing castors.
- Leg levelers can be backed out by hand (Image 1).
- Take two threaded castors and thread them into the existing leg leveler holes. (Image 2). Shims can be used between castor and cabinet frame rail for leveling (Image 3). Use the tool provided to tighten the threaded castors (Image 4).
- Repeat process for the other side of the cabinet.

WARNING: DISPLAY CASE MUST BE LEVELED ACCURATELY TO ENSURE FRONT GLASS DOOR SEALS PROPERLY.

- The unit should be leveled front to back and side to side with a level. Place the level in the interior floor of the unit and check all four sides.

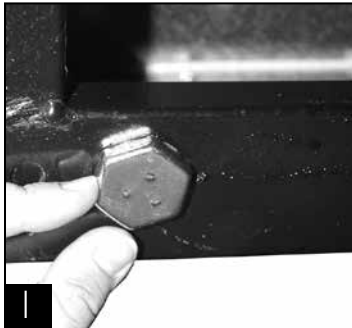

1 Back out leg levelers by hand, or with adjustable wrench.



2 Thread castors into existing leg leveler holes.



3 Use shims as necessary to level cabinet.



4 Tighten castor in position with castor wrench.

SEALING CABINET TO FLOOR

It may be necessary to seal the bakery case to the floor for local sanitary codes or if the customer so desires. TRUE recommends either of the following methods.

- Using a vinyl cove base trim as produced by Armstrong, Johnson, or Kentile (available at floor covering suppliers) or using mastics available at hardware stores.
- When applying the cove base trim, thoroughly clean both the cabinet and floor of dirt and grease. Apply a recommended contact cement to the cove base trim. After cove base trim has dried, fill in cracks and joints with a caulking material.
- When applying a mastic, thoroughly clean both the cabinet and floor of dirt and grease. Draw an outline of the cabinet on the floor. Raise and block the front side of the cabinet. Apply a bead of mastic to the floor 1/2" (1.3 cm) inside the outline drawn. Lower the cabinet. Raise and block the rear side of the cabinet. Apply the bead of mastic, lower the cabinet.

NOTE: Asphalt floors are very susceptible to chemical attack. A layer of tape on the floor prior to applying the sealant will protect the floor.

NSF APPROVED SEALANTS:

1. Minnesota Mining #ECU800 Caulk
2. Minnesota Mining #ECU2185 Caulk
3. Minnesota Mining #ECU1055 Bead
4. Minnesota Mining #ECU1202 Bead
5. Armstrong Cork - Rubber Caulk
6. Products Research Co. #5000 Rubber Caulk
7. G.E. Silicone Sealer
8. Dow Corning Silicone Sealer

SETUP

STANDARD ACCESSORIES

SHELF INSTALLATION (REFRIGERATED BAKERY & DRY BAKERY):

- A. Lift each door up and out of track (do not disconnect elastic tubing). Stretch elastic surgical tubing and set doors on each side of unit.
- B. Locate brackets, lights, shelves, etc. from cabinet interior.
- C. Locate shelf supports wrapped in micro foam and install teeth end into stainless pilasters located on interior walls. Adjust to desired height matching right and left pairs. (Images 1 & 2).
- D. Locate three horizontal lights wrapped in micro foam and install (light side down). Electrical cords should be on the right to plug into side receptacles.
- Hang end hooks of light assembly on two shelf supports (left and right) slide assembly forward until it seats in front notch of shelf support. (Image 3).
- E. Install rear brackets by sliding end hooks over rear notch of shelf support. (Image 4).
- F. Locate shelves, install top shelf first. With the front lip (tray stop) up and towards cabinet front, place on top of front light assembly and snap shelf into (2) clips on top of rear bracket (Image 5).
- G. Plug top light assembly into top receptacle of cabinet interior side wall (Image 5).
- H. Repeat procedures for remaining two shelves (Image 6).
- I. Replace doors in track.

WARNING: SHELF MOUNTED LIGHTING REQUIRES A CLOSED CIRCUIT. ALL PLUGS MUST BE PLUGGED INTO SIDE WALL RECEPTACLES FOR LIGHTS TO WORK. IF LESS THAN THREE SHELVES ARE INSTALLED BE SURE ATTACHED CAPS ARE PLUGGED INTO RECEPTACLE(S) (IMAGE 7).



1 Install shelf supports. teeth end into stainless pilasters.



2 Adjust to desired height matching right and left pairs.

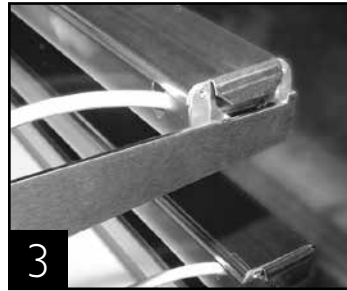

3 Hang end hooks of light assembly on front notch of shelf supports.



4 Install rear brackets.



5 Snap shelf into position.



6 Completed assembly.

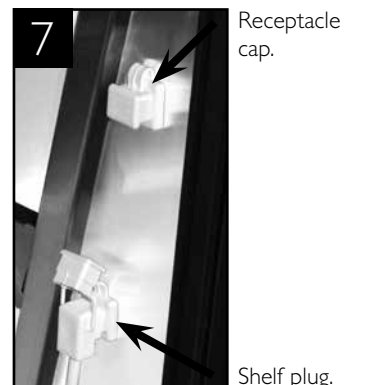

7 Receptacle cap.

Shelf plug.

SHELF INSTALLATION (COLD DELI):

- A. Lift each door up and out of track (do not disconnect elastic tubing). Stretch elastic surgical tubing and set doors on each side of unit.
- B. Locate brackets, lights, shelves, etc. from cabinet interior.
- C. Locate shelf supports wrapped in micro foam and install teeth end into stainless pilasters located on interior walls. Adjust to desired height matching right and left pairs. (images 1 & 2).
- D. Locate the stainless steel shelf and install with product stop towards the front of the cabinet. Side flaps should overlap shelf support. Be sure to fit shelf support tip into front slot of shelf (images 2 & 3).
- E. Plug light assembly into any receptacle of cabinet interior side wall (image 4).
- F. Replace doors in track.

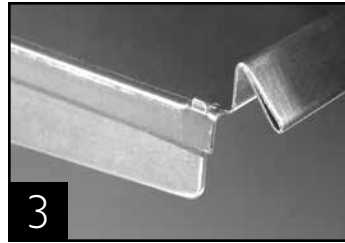
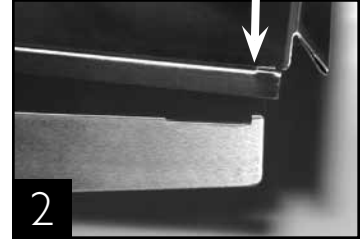

NOTE: THREE LIGHTING RECEPTACLES ALLOW FOR TWO ADDITIONAL, "OPTIONAL", LIGHTED SHELVES.

WARNING: SHELF MOUNTED LIGHTING REQUIRES A CLOSED CIRCUIT. ALL PLUGS MUST BE PLUGGED INTO SIDE WALL RECEPTACLES FOR LIGHTS TO WORK. IF LESS THAN THREE SHELVES ARE INSTALLED BE SURE ATTACHED CAPS ARE PLUGGED INTO RECEPTACLE(S) (IMAGE 4).

INSTALLATION OF OPTIONAL OVERLAY KIT FOR TCGD, TCGDZ & TCGR BAKERY CASES

OVERLAY KIT COMPONENTS:

- 2 - Overlay Top End Pieces
- 2 - Bottom End Pieces: (1) one left side (1) one right side
- 1 - Overlay Front Piece
- Tape (812918)

TOOLS REQUIRED:

- Phillips Screwdriver
- Silicone Spray (may be optional)

NOTE: PLEASE USE CARE WHEN INSTALLING THE OVERLAY.

NOTE: REFER TO FIGURE 1 FOR PLACEMENT OF OVERLAY PANELS.

STEP 1 - Install the front overlay panel.

Installing front overlay piece. Make sure the bottom end pieces are off in order to install the front overlay piece. Slide overlay into top and bottom tracks on the front of the cabinet. Make sure overlay is even on both left and right end of the cabinet. See Figures 1 & 2.

NOTE: The use of silicone spray may be used to assist with the installation of the front panel.

STEP 2 - Install the upper end overlay panel one on each side (this applies to both sides).

Install top end pieces. Make sure the bottom end pieces are off in order to install the top side overlay piece. Both side overlay pieces are the same size so they each can be used for left or right of the cabinet. Slide overlay up into black plastic tracks on the top side piece of each cabinet. See Figures 1, 2, & 3.

NOTE: After installing the bottom end pieces the top end overlay will stay in place.

STEP 3 - Install bottom end pieces (overlay is pre-glued to black plastic panel).

Line up the 4 keyhole slots in each bottom end piece to the 4 screws on the side of the cabinet. Slip the four large keyholes from the bottom end piece over the four screws. Then push down to fasten the bottom end piece onto the cabinet. See Figures 1 & 3.

NOTE: The bottom left and right pieces are not the same. The taller part of the bottom end piece goes to the rear of the cabinet. As shown in Figure 3.

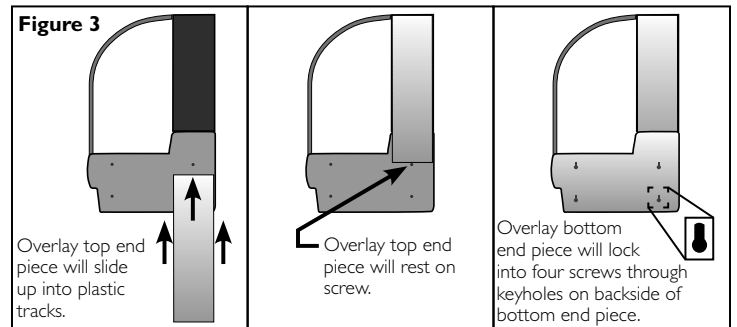
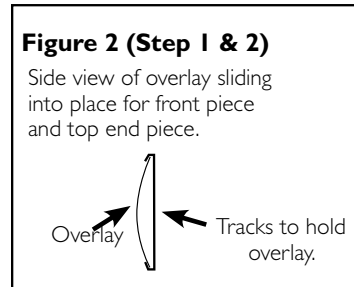
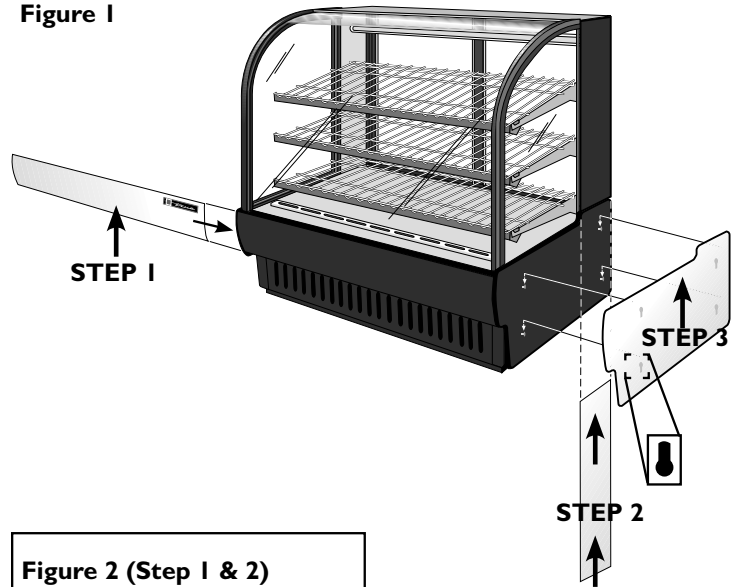

OPERATION

STARTUP

REFRIGERATED BAKERY AND COLD DELI ONLY

- A. The compressor is ready to operate. Plug in the cooler.
- B. Temperature controls are factory-set to give refrigerated bakery an approximate temperature of 38-40°F (3.3-4.4°C) and cold deli an approximate temperature of 36-38°F (2.2-3.3°C). Allow unit to function several hours, completely cooling cabinet before changing the control setting.

Temperature Control Location and Settings.

- Electronic temperature control is located on rear of unit or behind access grill. Correct baffle location.
- LAE temperature control is located on the front of cabinet countertop or in/behind louvered grill.
- Mechanical temperature control is located outside of unit.

See website for adjustments, sequence of operation, and more information.

- C. Excessive tampering with the control could lead to service difficulties. Should it ever become necessary to replace temperature control, be sure it is ordered from your TRUE dealer or recommended service agent.
- D. Good air flow in your TRUE unit is critical. Be careful to load product so that it neither presses against the back wall, nor comes within four inches of the evaporator housing. Refrigerated air off the coil must circulate down the back wall.

NOTE: If the unit is disconnected or shut off, wait five minutes before starting again.

RECOMMENDATION - Before loading product we recommend you run your TRUE unit empty for two to three days. This allows you to be sure electrical wiring and installation are correct and no shipping damage has occurred. Remember, our factory warranty does not cover product loss!

LIGHT SWITCH LOCATION

In most instances, the light switch is located next to the temperature control.

STARTUP

DRY BAKERY ONLY

Verify that the cabinet lights are working. Bakery cases are shipped with light switches in the "on" position. The toggle switch is located lower right corner at the rear.

MECHANICAL TEMPERATURE CONTROLS

COIL SENSING

An evaporator coil sensing temperature control ensures that the evaporator coil will remain clear of frost and ice by not allowing the compressor to restart until the coil temperature is above the freezing temperature. This is considered an **off cycle defrost**.



MECHANICAL CONTROL DELI DISPLAY GENERAL SEQUENCE OF OPERATION

1. Cabinet is plugged in.
 - a. Interior lights will illuminate. If lights do not come on verify the light switch is in the "ON" position.
2. A. The compressor and evaporator fans will start on a model TCGR if the temperature control is calling for cooling. (If the compressor does not start, verify that the temperature control is not in the "OFF" or "0" position.)
B. The compressor will start on models TSID, TDBD, and TCGG if the temperature control is calling for cooling. (The above 3 models are a gravity style coil design and do not have an evaporator fan motor.)
3. The temperature control may cycle the compressor and evaporator fan(s) on and off together.
 - a. The temperature control is sensing the evaporator coil temperature.
 - b. The temperature control should be set on the #4 or #5.
 - c. The warmest setting is #1, the coldest is #9, and #0 is the off position.
 - d. The thermometer is designed to read and display a cabinet temperature **not a product temperature**. The thermometer may reflect the refrigeration cycle swings of up and down temperatures. The most accurate temperature on a cabinet's operation is to verify the product temperature.
4. A. There is not a defrost timer on a model TCGR as the temperature control will initiate the off-cycle defrost during each refrigeration cycle.
 - a. At this time, the compressor will turn off. No heaters will be energized.
 - b. After the evaporator coil temperature has been reached determined by the temperature control, the compressor will restart.
B. The defrost timer will initiate defrost on models TSID, TDBD, and TCGG during specific times of day.
 - a. At this time, the compressor will turn off. No heaters will be energized.
 - b. After the predetermined duration has expired, the compressor will restart

WHEN TO MAKE AN ADJUSTMENT TO A MECHANICAL TEMPERATURE CONTROL

We advise to make a mechanical temperature control adjustment only for a high altitude location.



HOW TO ADJUST A MECHANICAL TEMPERATURE CONTROL

OPERATION INSTRUCTIONS:

REQUIRED TOOLS:

- Jewelers Screw Driver (Small Screw Driver)

GE CONTROL INSTRUCTIONS:

The scale to the right may be used as a guide for measuring degrees of rotation required for altitude correction. See Figure 1. The arrows indicate direction of screw rotation. Turn calibration screw clockwise to obtain warmer operating temperatures.

NOTE: Each 1/4 turn of the calibration screw is equal to approximately 2 degrees F. Do not make more than 3/4 turn. After making adjustment, measure temperature during three cycles before adjusting again.

NOTE: Only adjust the screw (small flathead) on the face of the control (next to the cam). See Figure 3. Follow the Altitude Correction Table to the right.

ALTITUDE CORRECTION TABLE: CALIBRATION SCREW ADJUSTS BOTH CUT-IN AND CUT-OUT

Altitude (Feet)	Clockwise Turns
2000	7/60
3000	11/60
4000	15/60
5000	19/60
6000	23/60
7000	27/60
8000	30/60
9000	34/60
10,000	37/60

Scale Guide for Measuring

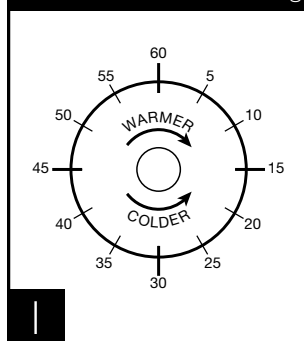

Back of Temperature Control

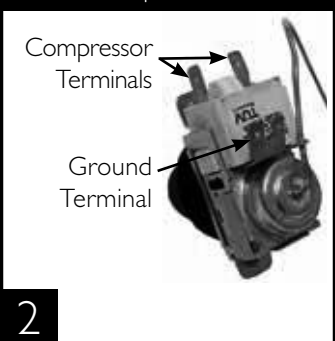

Altitude Correction Front of Temperature Control

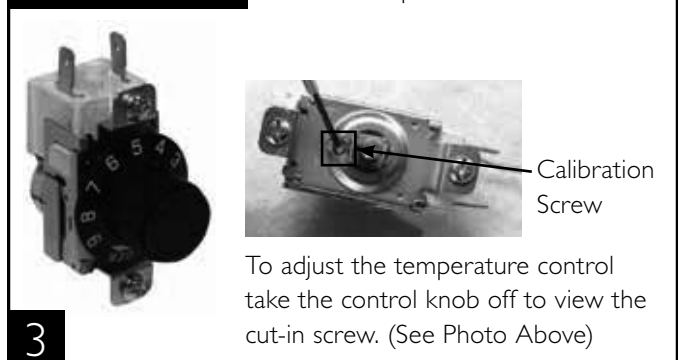

INSTALLATION INSTRUCTIONS DANFOSS TEMPERATURE CONTROL ADJUSTMENT FOR HIGH ALTITUDE APPLICATIONS:

REQUIRED TOOLS:

- Allen Wrench (5/64")
- Torx Screw (T-7)

TERMS:

Cut-out - Temperature sensed by the controller that shuts the compressor off.

Cut-in - Temperature sensed by the controller that turns the compressor on.

Bottom of Temperature Control

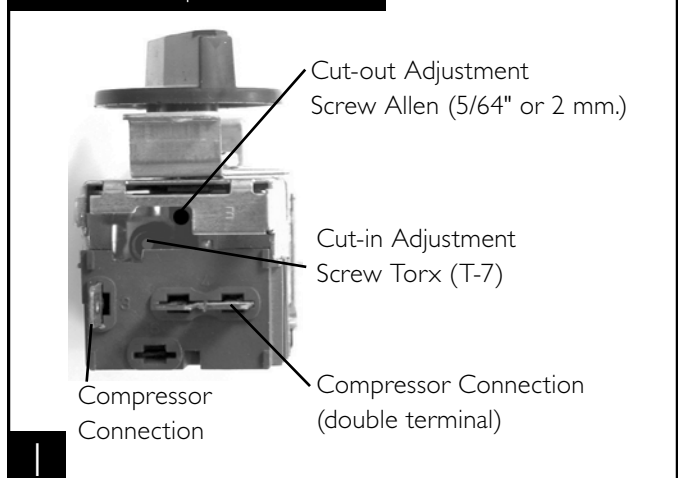

INSTRUCTIONS: DANFOSS TEMPERATURE CONTROL ADJUSTMENT FOR HIGH ALTITUDE APPLICATIONS

STEP 1 - Unplug cooler.

STEP 2 - Remove the screws that secure the temperature control to the inset box.

STEP 3 - To make these adjustments it may be necessary to remove the temperature control from the housing.

NOTE: You may have to remove the wires attached to the control. Take note as to which wire is on which spade terminal.

STEP 4 - Pull out gently from cabinet.

NOTE: Mechanical temperature controllers are affected when functioning at high altitude. The cut-in and cut-out temperatures will be colder than when the controller functions closer to sea level.

STEP 5 - For high elevation installations, it may be necessary to "warm-up" the set points. To make the adjustment, insert the appropriate tool in each adjustment screw and turn 1/4 of a revolution clockwise (to the right). This procedure will adjust both the cut-in and cut-out about 2°F warmer.

STEP 6 - Make sure to reconnect the wires to the proper spade terminal when reinstalling.

INSTALLATION INSTRUCTIONS TEMPERATURE CONTROL ALTITUDE ADJUSTMENT:

REQUIRED TOOLS:

- Allen Wrench (5/64")
- Torx Screw (T-7)

The scale to the right may be used as a guide for measuring degrees of rotation required for altitude correction. The arrows indicate direction of screw rotation. See Figure 1.

IMPORTANT: Upright models ordered with "High Altitude" temperature controls are pre-calibrated and do not require adjustment.

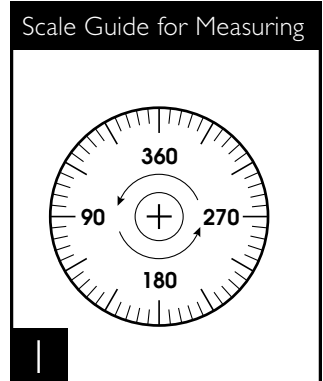

INSTRUCTIONS: CUTLER HAMMER TEMPERATURE CONTROL ALTITUDE ADJUSTMENT

STEP 1 - Unplug cooler.

STEP 2 - Turn the temperature control to the "9" position.

STEP 3 - Remove the screws that secure the mounting plate to the evaporator top. See Figure 2.

STEP 4 - Pull control down gently from housing.

STEP 5 - Turn screws counterclockwise (CCW).

STEP 6 - Reassemble to cooler housing and return the temperature control to the "5" position.

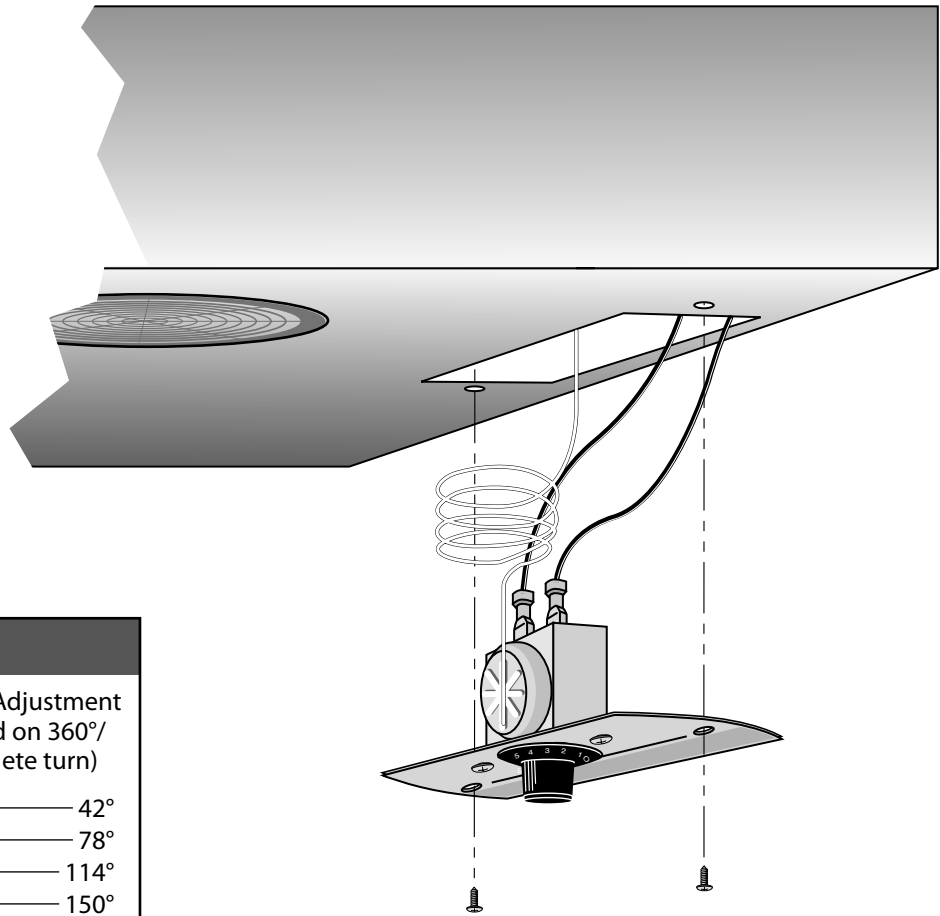
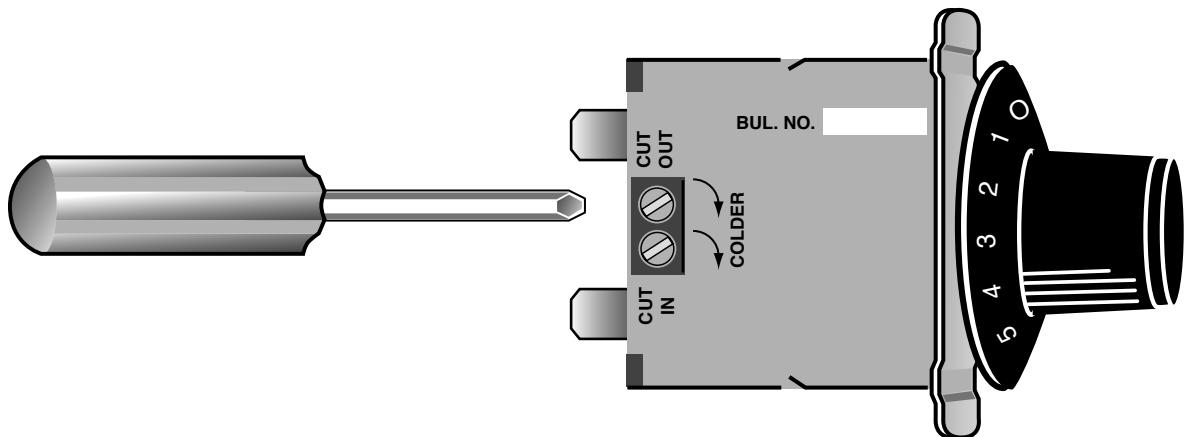

CHART	
Height	CCW Adjustment (based on 360°/ complete turn)
2000'	42°
3000'	78°
4000'	114°
5000'	150°
6000'	186°
7000'	222°
8000'	258°
9000'	294°
10,000'	330°



MAINTENANCE, CARE, CLEANING

CLEANING THE CONDENSER COIL

REFRIGERATED BAKERY & COLD DELI

When using electrical appliances, basic safety precautions should be followed, including the following:

TOOLS REQUIRED

- Phillips Screwdriver
- Stiff Bristle Brush
- Adjustable Wrench
- Air Tank or CO2 Tank
- Vacuum Cleaner

STEP 1 - Disconnect power to unit.

STEP 2 - Take off rear lower grill assembly by removing two (2) bottom screws. If necessary, loosen screws holding the top pivot pins. Swing grill up and remove frame hooks from pivot pins at top of louver.

STEP 3 - Remove bolts anchoring compressor assembly to frame rails and carefully slide out (tube connections are flexible).

STEP 4 - Clean off accumulated dirt from condensing coil with a stiff bristle brush.

STEP 5 - After brushing condenser coil vacuum dirt from coil and interior floor.

STEP 6 - Carefully slide compressor assembly back into position and replace bolts.

STEP 7 - Connect unit to power and check to see if condenser is running.

STEP 8 - Reinstall louver assembly onto unit, tighten all screws.

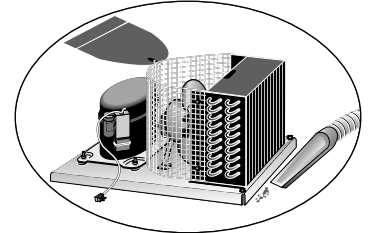
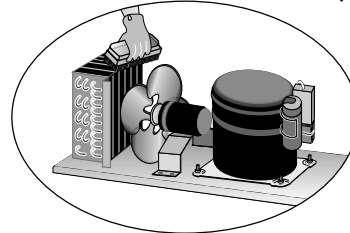
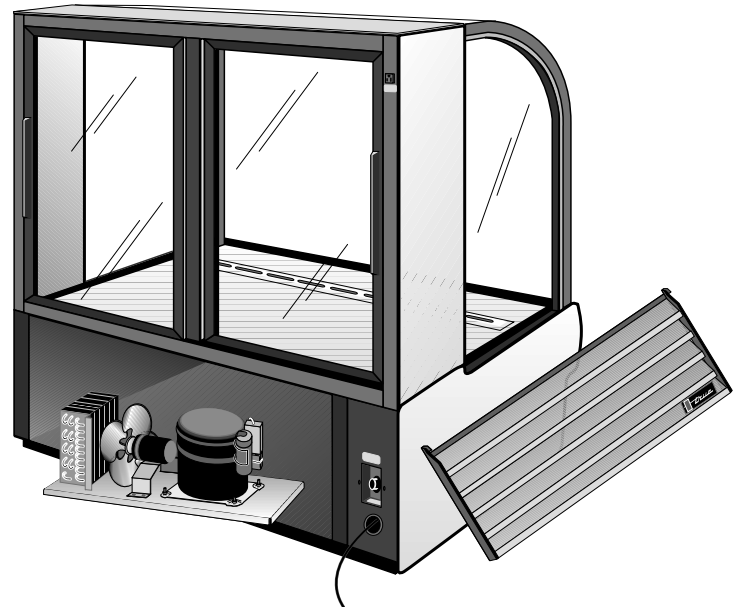

IMPORTANT WARRANTY INFORMATION

Condensers accumulate dirt and require cleaning every 30 days. Dirty condensers result in compressor failure, product loss, and lost sales, which are not covered by warranty.

If you keep the Condenser clean you will minimize your service expense and lower your electrical costs. The Condenser requires scheduled cleaning every thirty days or as needed.

Air is pulled through the Condenser continuously, along with dust, lint, grease, etc.

A dirty Condenser can result in NON-WARRANTEED part & Compressor Failures, Product Loss, and Lost Sales.

Proper cleaning involves removing dust from the Condenser. By using a soft brush, or vacuuming the Condenser with a shop vac, or using CO₂, nitrogen, or pressurized air.

If you cannot remove the dirt adequately, please call your refrigeration service company.

On most of the reach-in units the condenser is accessible in the rear of the unit. You must remove the cabinet grill to expose the Condenser.

The Condenser looks like a group of vertical fins. You need to be able to see through the condenser for the unit to function at maximum capacity. Do not place filter material in front of condensing coil. This material blocks air-flow to the coil similar to having a dirty coil.

THE CLEANING OF THE CONDENSER IS NOT COVERED BY THE WARRANTY!

HOW TO CLEAN THE CONDENSER:

1. Disconnect the electrical power to the unit.
2. Remove the louvered grill.
3. Vacuum or brush the dirt, lint, or debris from the finned condenser coil.
4. If you have a significant dirt build up you can blow out the condenser with compressed air.

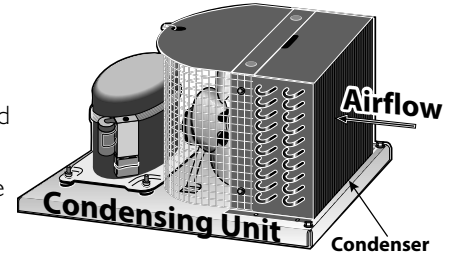

(CAUTION MUST BE USED TO AVOID EYE INJURY. EYE PROTECTION IS RECOMMENDED.)

5. When finished be sure to replace the louvered grill. The grill protects the condenser.
6. Reconnect the electrical power to the unit.

If you have any questions, please call TRUE Manufacturing at 636-240-2400 or 800-325-6152 and ask for the Service Department. Direct to Service Department 1 (855)372-1368. Service Department Availability Monday-Thursday 7:00 a.m. to 7:00 p.m., Friday 7:00 a.m. to 6:00 p.m. and Saturday 8:00 a.m. to 12:00 p.m. CST.

STAINLESS STEEL EQUIPMENT CARE AND CLEANING

CAUTION: Do not use any steel wool, abrasive or chlorine based products to clean stainless steel surfaces.

STAINLESS STEEL OPPONENTS

There are three basic things which can break down your stainless steel's passivity layer and allow corrosion to rear its ugly head.

1. Scratches from wire brushes, scrapers, and steel pads are just a few examples of items that can be abrasive to stainless steel's surface.
2. Deposits left on your stainless steel can leave spots. You may have hard or soft water depending on what part of the country you live in. Hard water can leave spots. Hard water that is heated can leave deposits if left to sit too long. These deposits can cause the passive layer to break down and rust your stainless steel. All deposits left from food prep or service should be removed as soon as possible.
3. Chlorides are present in table salt, food, and water. Household and industrial cleaners are the worst type of chlorides to use.

RECOMMENDED CLEANERS FOR CERTAIN SITUATIONS / ENVIRONMENTS OF STAINLESS STEEL

- A. Soap, ammonia and detergent medallion applied with a cloth or sponge can be used for routine cleaning.
- B. Arcal 20, Lac-O-Nu Ecoshine applied provides barrier film for fingerprints and smears.
- C. Cameo, Talc, Zud First Impression is applied by rubbing in the direction of the polished lines for stubborn stains and discoloring.
- D. Easy-off and De-Grease It oven aid are excellent for removals on all finishes for grease-fatty acids, blood and burnt-on foods.
- E. Any good commercial detergent can be applied with a sponge or cloth to remove grease and oil.
- F. Benefit, Super Sheen, Sheila Shine are good for restoration / passivation.

NOTE: The use of stainless steel cleaners or other such solvents is not recommended on plastic parts. Warm soap and water will suffice.

8 STEPS THAT CAN HELP PREVENT RUST ON STAINLESS STEEL:

1. USING THE CORRECT CLEANING TOOLS

Use non-abrasive tools when cleaning your stainless steel products. The stainless steel's passive layer will not be harmed by soft cloths and plastic scouring pads. Step 2 tells you how to find the polishing marks.

2. CLEANING ALONG THE POLISH LINES

Polishing lines or "grain" are visible on some stainless steels. Always scrub parallel to visible lines on some stainless steels. Use a plastic scouring pad or soft cloth when you cannot see the grain.

3. USE ALKALINE, ALKALINE CHLORINATED OR NON-CHLORIDE CONTAINING CLEANERS

While many traditional cleaners are loaded with chlorides, the industry is providing an ever increasing choice of non-chloride cleaners. If you are not sure of your cleaner's chloride content contact your cleaner supplier. If they tell you that your present cleaner contains chlorides, ask if they have an alternative. Avoid cleaners containing quaternary salts as they can attack stainless steel, causing pitting and rusting.

4. WATER TREATMENT

To reduce deposits, soften the hard water when possible. Installation of certain filters can remove corrosive and distasteful elements. Salts in a properly maintained water softener can be to your advantage. Contact a treatment specialist if you are not sure of the proper water treatment.

5. MAINTAINING THE CLEANLINESS OF YOUR FOOD EQUIPMENT

Use cleaners at the recommended strength (alkaline chlorinated or non-chloride). Avoid build-up of hard stains by cleaning frequently. When boiling water with your stainless steel equipment, the single most likely cause of damage is chlorides in the water. Heating any cleaners containing chlorides will have the same damaging effects.

6. RINSE

When using chlorinated cleaners you must rinse and wipe dry immediately. It is better to wipe standing cleaning agents and water as soon as possible. Allow the stainless steel equipment to air dry. Oxygen helps maintain the passivity film on stainless steel.

7. HYDROCHLORIC ACID (MURIATIC ACID) SHOULD NEVER BE USED ON STAINLESS STEEL

8. REGULARLY RESTORE/PASSIVATE STAINLESS STEEL

GENERAL MAINTENANCE

SHELF MOUNTED BULB REPLACEMENT:

WARNING: When replacing a light bulb make sure power to the unit is either turned off or unplugged.

- Unplug the light assembly from the receptacle on the interior side wall. Remove shelf and light assembly from cabinet.
- Remove the lampshield by gently squeezing the sides together and rotating out (Image 1).
- Remove bulb from the corded end of assembly by holding the bulb and gently pulling up on spring loaded lampholder which will allow enough clearance to remove bulb (Image 2).
- Install new bulb using spring loaded lampholder.
- Reinstall light assembly and shelf. Plug cord into side wall receptacle.

NOTE: All spring loaded lampholders are located on the left side of the cabinet as you face the front.

NOTE: Please be aware of your local ordinances for disposal of old florescent bulbs. These bulbs should be disposed of in a safe and proper manner.

INTERIOR TOP BULB REPLACEMENT:

WARNING: When replacing a light bulb make sure power to the unit is either turned off or unplugged.

- Remove the lampshield by gently squeezing the sides together and rotating out (Image 3).
- Remove bulb by gently pushing bulb back into spring loaded lampholder which will allow enough clearance to remove bulb (Image 4).
- Install new bulb using spring loaded lampholder.
- Reinstall light lampshield by sliding rear "U" channel of lampshield over metal bracket and gently squeezing lampshield to fit front "U" channel over front metal bracket (Images 5-6).
- Image 7 shows assembly properly installed.



1 Squeeze lampshield and rotate out.

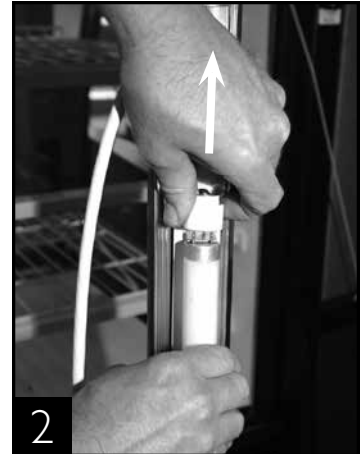

2 Remove bulb by gently pulling up on spring loaded lampholder.



3 Squeeze lampshield and rotate out.



4 Remove bulb by gently pushing bulb into spring loaded lampholder.



5 Squeeze lampshield "U" channel into position over metal bracket.



6 lampshield "U" channel in position over metal bracket.



7 Interior top light assembly properly installed.

**FOR ADDITIONAL MAINTENANCE INSTRUCTION,
PLEASE VISIT THE MEDIA CENTER AT
WWW.TRUEMFG.COM**



WARRANTY INFORMATION (U.S.A & CANADA ONLY!)

THIS WARRANTY ONLY APPLIES TO UNITS SHIPPED FROM TRUE'S MANUFACTURING FACILITIES AFTER JULY 1, 2014.

THREE YEAR PARTS & LABOR WARRANTY

TRUE warrants to the original purchaser of every new TRUE refrigerated unit, the cabinet and all parts thereof, to be free from defects in material or workmanship, under normal and proper use and maintenance service as specified by TRUE and upon proper installation and start-up in accordance with the instruction packet supplied with each TRUE unit. TRUE's obligation under this warranty is limited to a period of three (3) years from the date of original installation or 39 months after shipment date from TRUE, whichever occurs first.

Any part covered under this warranty that are determined by TRUE to have been defective within three (3) years of original installation or thirty-nine (39) months after shipment date from manufacturer, whichever occurs first, is limited to the repair or replacement, including labor charges, of defective parts or assemblies. The labor warranty shall include standard straight time labor charges only and reasonable travel time, as determined by TRUE.

Warranty does not cover standard wear parts which include door gaskets, incandescent bulbs or fluorescent bulbs. Warranty also does not cover issues caused by improper installation or lack of basic preventative maintenance which includes regular cleaning of condenser coils.

ADDITIONAL TWO YEAR COMPRESSOR WARRANTY

In addition to the Three (3) year warranty stated above, TRUE warrants its hermetically and semi-hermetically sealed compressor to be free from defects in both material and workmanship under normal and proper use and maintenance service for a period of two (2) additional years from the date of original installation but not to exceed five (5) years and three (3) months after shipment from the manufacturer.

Compressors determined by TRUE to have been defective within this extended time period will, at TRUE's option, be either repaired or replaced with a compressor or compressor parts of similar design and capacity.

The two (2) year extended compressor warranty applies only to hermetically and semi-hermetically sealed parts of the compressor and does not apply to any other parts or components, including, but not limited to: cabinet, paint finish, temperature control, refrigerant, metering device, driers, motor starting equipment, fan assembly or any other electrical component, etcetera.

404A/134A COMPRESSOR WARRANTY

The two year compressor warranty detailed above will be voided if the following procedure is not carefully adhered to:

1. This system contains R404A or R134A refrigerant and polyol ester lubricant. The polyol ester lubricant has rapid moisture absorbing qualities. If long exposure to the ambient conditions occur, the lubricant must be removed and replaced with new. For oil amounts and specifications please call TRUE technical service department (855-372-1368). Failure to comply with recommended lubricant specification will void the compressor warranty.
2. Drier replacement is very important and must be changed when a system is opened for servicing. A drier using XH-7 desiccant or an exact replacement solid core drier must be used. The new drier must also be the same capacity as the drier being replaced.
3. Micron level vacuums must be achieved to insure low moisture levels in the system. 500 microns or lower must be obtained.

WARRANTY CLAIMS

All claims for labor or parts must be made directly through TRUE. All claims should include: model number of the unit, the serial number of the cabinet, proof of purchase, date of installation, and all pertinent information supporting the existence of the alleged defect.

In case of warranty compressor; the compressor model tag must be returned to TRUE along with above listed information.

Any action or breach of these warranty provisions must be commenced within one (1) year after that cause of action has occurred.

WHAT IS NOT COVERED BY THIS WARRANTY

TRUE's sole obligation under this warranty is limited to either repair or replacement of parts, subject to the additional limitations below. This warranty neither assumes nor authorizes any person to assume obligations other than those expressly covered by this warranty.

NO CONSEQUENTIAL DAMAGES. TRUE IS NOT RESPONSIBLE FOR ECONOMIC LOSS; PROFIT LOSS; OR SPECIAL, INDIRECT, OR CONSEQUENTIAL DAMAGES, INCLUDING WITHOUT LIMITATION, LOSSES OR DAMAGES ARISING FROM FOOD OR PRODUCT SPOILAGE CLAIMS WHETHER OR NOT ON ACCOUNT OF REFRIGERATION FAILURE. **WARRANTY IS NOT TRANSFERABLE.** This warranty is not assignable and applies only in favor of the original purchaser/user to whom delivered. ANY SUCH ASSIGNMENT OR TRANSFER SHALL VOID THE WARRANTIES HEREIN MADE AND SHALL VOID ALL WARRANTIES, EXPRESS OR IMPLIED, INCLUDING ANY WARRANTY OF MERCHANTABILITY OR FITNESS FOR A PARTICULAR PURPOSE.

IMPROPER USAGE. TRUE ASSUMES NO LIABILITY FOR PARTS OR LABOR COVERAGE FOR COMPONENT FAILURE OR OTHER DAMAGES RESULTING FROM IMPROPER USAGE OR INSTALLATION OR FAILURE TO CLEAN AND/OR MAINTAIN PRODUCT AS SET FORTH IN THE WARRANTY PACKET PROVIDED WITH THE UNIT.

RELOCATION OF CABINET FOR REPAIR: True is not responsible for the cost to move a cabinet for any reason from its position of operation on the customer's premises to make a warranty repair.

RESIDENTIAL APPLICATIONS: TRUE assumes no liability for parts or labor coverage for component failure or other damages resulting from installation in non-commercial or residential applications.

ALTERATION, NEGLIGENCE, ABUSE, MISUSE, ACCIDENT, DAMAGE DURING TRANSIT OR INSTALLATION, FIRE, FLOOD, ACTS OF GOD. TRUE is not responsible for the repair or replacement of any parts that TRUE determines have been subjected after the date of manufacture to alteration, neglect, abuse, misuse, accident, damage during transit or installation, fire, flood, or act of God.

IMPROPER ELECTRICAL CONNECTIONS. TRUE IS NOT RESPONSIBLE FOR THE REPAIR OR REPLACEMENT OF FAILED OR DAMAGED COMPONENTS RESULTING FROM INCORRECT SUPPLY VOLTAGE, THE USE OF EXTENSION CORDS, LOW VOLTAGE, OR UNSTABLE SUPPLY VOLTAGE. **NO IMPLIED WARRANTY OF MERCHANTABILITY OR FITNESS FOR A PARTICULAR PURPOSE:** THERE ARE NO OTHER WARRANTIES, EXPRESSED, IMPLIED OR STATUTORY, EXCEPT THE THREE (3) YEAR PARTS & LABOR WARRANTY AND THE ADDITIONAL TWO (2) YEAR COMPRESSOR WARRANTY AS DESCRIBED ABOVE. THESE WARRANTIES ARE EXCLUSIVE AND IN LIEU OF ALL OTHER WARRANTIES, INCLUDING IMPLIED WARRANTY AND MERCHANTABILITY OR FITNESS FOR A PARTICULAR PURPOSE. THERE ARE NO WARRANTIES WHICH EXTEND BEYOND THE DESCRIPTION ON THE FACE HEREOF.

OUTSIDE U.S./Canada: This warranty does not apply to, and TRUE is not responsible for; any warranty claims made on products sold or used outside the United States/Canada. This warranty only applies to units shipped from True's manufacturing facilities after July 1, 2014.