

REFRIGERATOR MANUFACTURER
Turbo air

Turbo Air Speeds up the Pace of Innovation

M3-Series Refrigerators & Freezers Installation and Operation Manual

Please read this manual completely before attempting to install or operate this equipment!

SOLID DOOR REFRIGERATORS

M3R19-1
M3R24-1 M3R24-2
M3R47-2 M3R47-4
M3R72-3 M3R72-6

SOLID DOOR FREEZERS

M3F19-1
M3F24-1 M3F24-2
M3F47-2 M3F47-4
M3F72-3 M3F72-6



CONTENTS

	PAGE
1. SPECIFICATIONS	2
2. SERIAL NUMBER	2
3. INSTALLATION	3
4. CLEANING & CAUTION	4
5. BASIC OPERATION	
5-1. REFRIGERATORS	5~6
5-2. FREEZERS	7~8
6. REVERSIBLE DOOR INSTRUCTIONS	9~12
7. TROUBLESHOOTING	13
8. STAINLESS STEEL EQUIPMENT CARE AND CLEANING	14~16
9. WARRANTY	16~18

SPECIFICATIONS

Refrigerators

MODEL	COMP H.P.	V/Hz	REFRIGERANT	AMPS	WEIGHT
M3R19-1	1/4	115V/60Hz	R-134A	4.2A	194lbs
M3R24-1	1/4	115V/60Hz	R-134A	5.5A	270lbs
M3R24-2	1/4	115V/60Hz	R-134A	5.5A	270lbs
M3R47-2	1/3	115V/60Hz	R-134A	9.2A	401lbs
M3R47-4	1/3	115V/60Hz	R-134A	9.2A	401lbs
M3R72-3	1/2	115V/60Hz	R-134A	11.3A	559lbs
M3R72-6	1/2	115V/60Hz	R-134A	11.3A	559lbs

Freezers

MODEL	COMP H.P.	V/Hz	REFRIGERANT	AMPS	WEIGHT
M3F19-1	1/3	115V/60Hz	R-404A	5.3A	194lbs
M3F24-1	1/2	115V/60Hz	R-404A	7.8A	280lbs
M3F24-2	1/2	115V/60Hz	R-404A	7.8A	280lbs
M3F47-2	3/4	115V/60Hz	R-404A	10.5A	435lbs
M3F47-4	3/4	115V/60Hz	R-404A	10.5A	435lbs
M3F72-3	1 1/4	115V/208~230/60	R-404A	10.4A	571lbs
M3F72-6	1 1/4	115V/208~230/60	R-404A	10.4A	571lbs

SERIAL NUMBER

The serial number is located on the data label inside.

Please retain the unit's serial number for service purpose.

INSTALLATION

1. GOOD AIR CIRCULATION

- Be sure to avoid any partition and object which may stop the air flow.
- Be sure that air space is allowed to flow the rear of the unit.
(Turbo air recommends that the rear of the unit would be no less than 5 inches from the wall.)

2. PLACE ON STRONG GROUND

- Be sure that the location be chosen has a strong enough floor to support the total weight of the cabinet and any other contents.

3. DO NOT PLACE NEAR HEAT

- Be sure to avoid hot corners and locations near stoves.
- High ambient temperature will make much lower cooling efficiency.

4. INDOOR USAGE ONLY

- Be sure to install this unit indoor.
- It should prohibit getting wet from the rain.

5. STABILIZING

- Make sure the unit is installed in a stable condition with the front wheels locked while in use.

6. LEVELING

- Be sure that the unit levels from the front to the back and side to side.

7. UNIT SHOULD BE ON DEDICATED OUTLET.

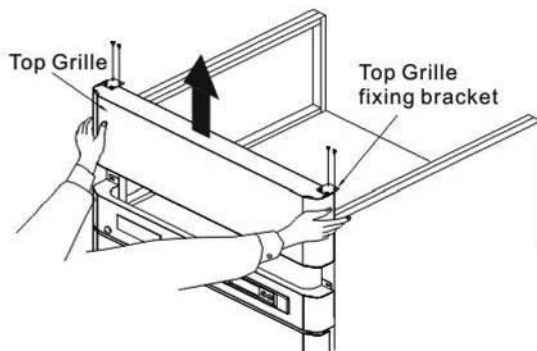

<HOW TO REMOVE THE TOP GRILLE>

After unscrewing two of the Top Grille Fixing Brackets. Slide up the Top Grille as the picture for service or cleaning.

CLEANING

1. CLEANING THE INTERIOR AND EXTERIOR

- The interior and exterior of the unit can be cleaned using warm water with soap.
- Do not use an abrasive cleaner because it will scratch the surface.

2. CLEANING THE CONDENSER FINS

- To maintain proper refrigeration performance, the Condenser coil must be free of dust, dirt, and grease.

This will require periodic cleaning. Condenser fins should be cleaned at least every three months (90 days) or as needed.

3. CLEAN THE GASKET

- The door gasket should be cleaned frequently to maintain proper sealing.

4. CHECK AFTER CLEANING

- Check the unit again for safety.
- Check that the unit is operating properly.

CAUTION

1. POWER CORD

- Be sure that the power cord is connected to the proper voltage.
- A protected circuit of the correct voltage and amperage must be run for connection of the line cord.
- Turn 'off' the power switch before disconnecting the power cord, whenever performing maintenance functions or cleaning the refrigerated cabinet.
- Dual voltage freezer (M3F72-3, M3F72-6) requires receptacle as shown the right sides.
- Compressor warranties are void if compressor burns out due to low voltage.

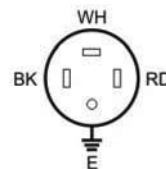

2. RE-STARTING

- If disconnected, wait for 5 minutes before re-starting.

BASIC OPERATION

REFRIGERATORS

M3R19-1	
M3R24-1	M3R24-2
M3R47-2	M3R47-4
M3R72-3	M3R72-6

1. Plug in and turn on the power switch located on the control box.
The display panel will be lighted and make a beep sound. The compressor will begin to run.
2. The default temperature setting is No. "4".
3. The compressor is automatically cycled by the electronic controller (PCB, RD-Sensor).
4. The defrost cycle is automatically controlled by the PCB.
5. Set level toward "1" for higher temperature and toward "7" for lower temperature.
6. The interior light is activated by the rocker switch at the bottom of the grille when the door is opened.
7. Evaporator fan motor(s) will run after all doors are completely closed.

DISPLAY PANEL OF REFRIGERATOR

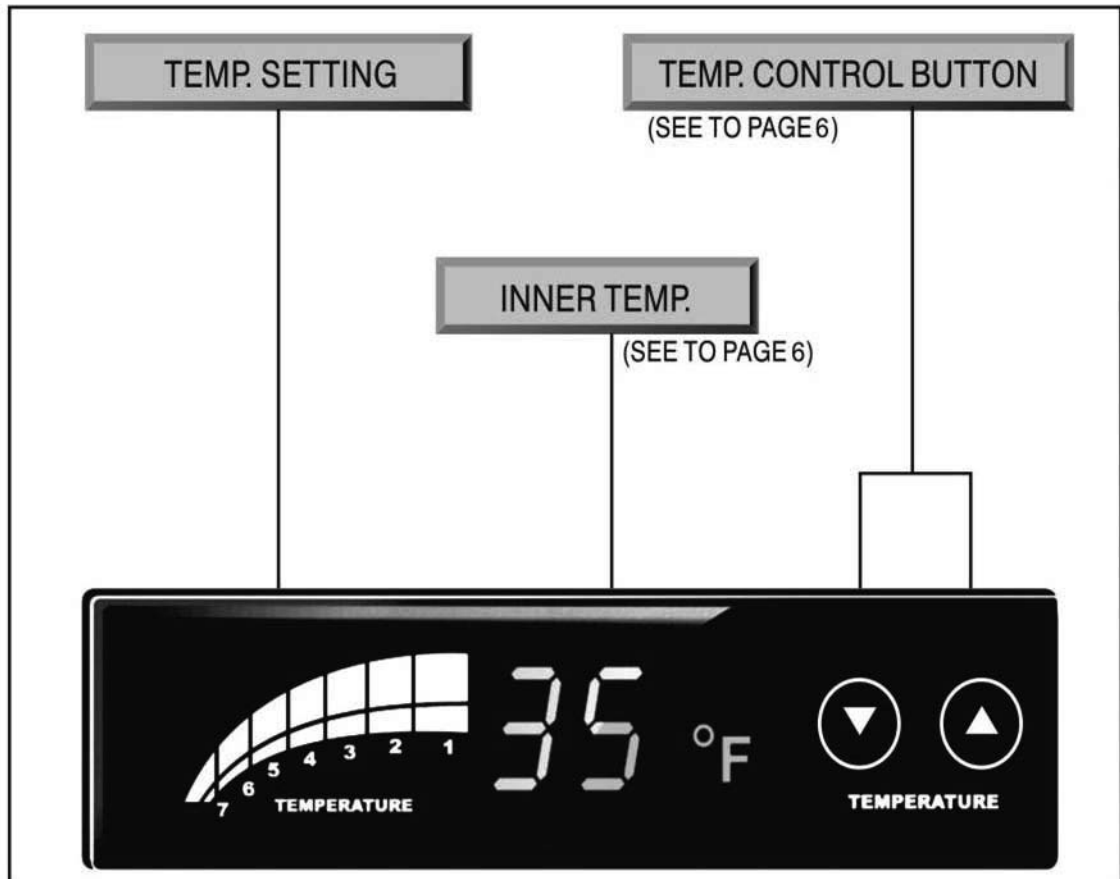

UP/DOWN BUTTON (Temperature control button)

1. By pushing the up/down button, you can set the inside temperature level from '1' to '7'.
2. If you want lower temperature, push the Down button to be lighted higher level numbers.

INNER TEMPERATURE DISPLAY

1. It displays the inside temperature.
2. Display range is 14°F to 69°F (-10°C ~ +20°C).
3. When the inside temperature is lower than 14°F, the panel will display 'L0'.

00

and, higher than 69°F, the panel will display 'HI'.

00

FAN RUNNING

1. Evaporator fan motor is activated when the door (both doors for M3R47-2, M3R47-4, all three doors for M3R72-3, M3R72-6) is closed.

BASIC OPERATION

Freezers

M3F19-1	M3F24-2
M3F24-1	M3F47-4
M3F47-2	M3F72-6
M3F72-3	

1. Plug in and turn on the power switch located on the bottom of the top grille right side. The display panel will be lighted and make a beep sound. The compressor will begin to run.
2. The default temperature setting is No. "4".
3. The compressor is automatically cycled by the electronic controller (PCB, F-Sensor).
4. The defrost cycle is automatically controlled by the RD-sensor, and the PCB.
5. Set level toward "1" for higher temperature and toward "7" for lower temperature.
6. The interior light is activated by the rocker switch at the bottom of the grille when the door is opened.
7. Evaporator fan motor(s) will run after all doors are completely closed.
8. Good Air Flow in freezer unit is critical.
Be careful to load product so that it neither presses against the back wall, nor reaches within four inches from the evaporator compartment.

DISPLAY PANEL OF FREEZER

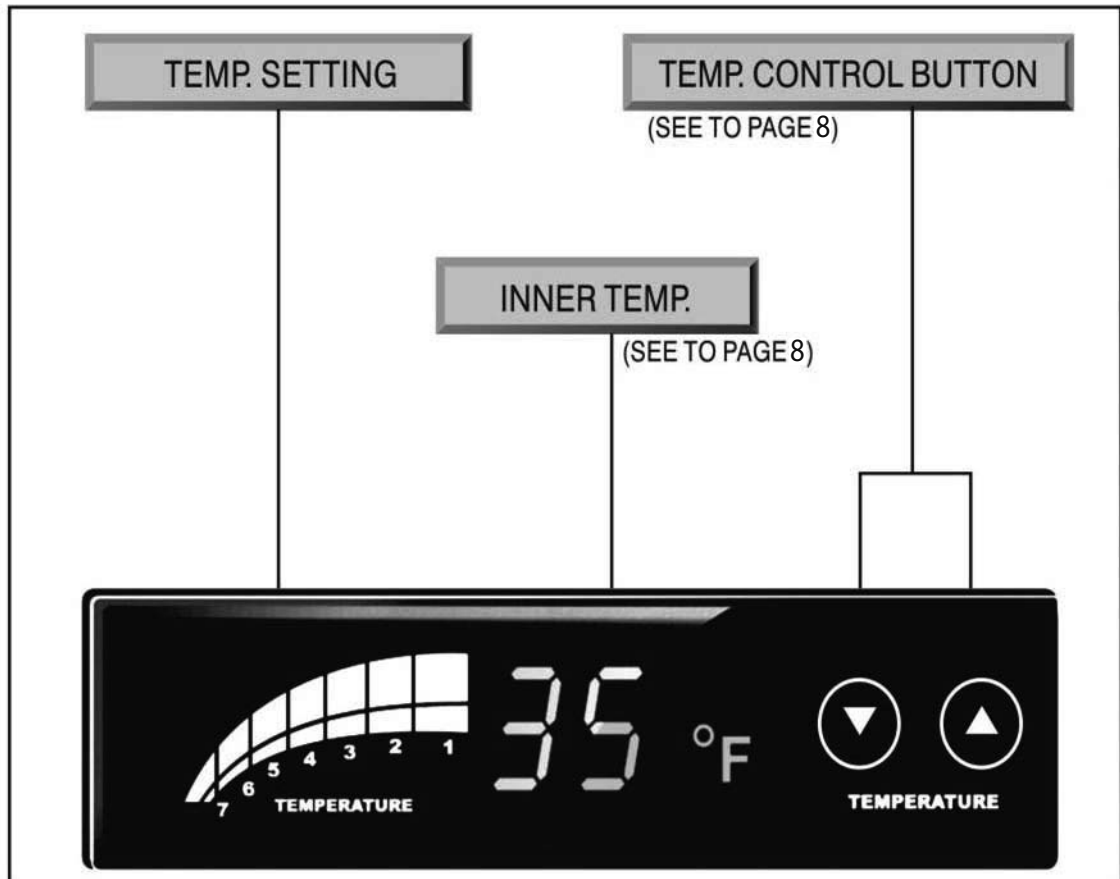

INNER TEMPERATURE DISPLAY

1. Press the down (▼) button 5 times while pressing up (▲) button, the Defrost will start.
2. During the Manual Defrost mode, the Up/Down button for the temp, control can not make the compressor cycle ON or OFF.

UP/DOWN BUTTON (Temperature control button)

1. By pushing the up/down button, you can set the inside temperature level from '1' to '7'.
2. If you want lower temperature, push the Down button to be lighted higher level numbers.

DEFROST

1. The electronic defrost controller is set at the factory to provide a defrost cycle every 6 hours (4 times per a day).
2. If it is necessary to change the intervals of defrost due to unusual operating conditions, it can be accomplished by adjusting the switch which is located on the inside of the top grille.
3. The panel displays “dF” during the defrost cycle.

INNER TEMPERATURE DISPLAY

1. It displays the inside temperature.
2. Display range is -50°F to 50°F (-45°C ~ +10°C).
3. When the inside temperature is lower than -50°F, the panel will display 'LO'.

LO

and, higher than 50°F, the panel will display 'HI'.

HI

FAN RUNNING

1. Evaporator fan motor is activated when the door (both doors for M3F47-2, M3F47-4, all three doors for M3F72-3, M3F72-6) is closed.

REVERSIBLE DOOR INSTRUCTIONS

(For M3R-19-1 / M3R-24-1 / M3F-19-1 / M3F-24-1)

1.TOP GRILLE(T) AND TOP GRILLE (B)

A. Disassemble the top grille fixture as below.



B. Lift top grille (T) as illustrated below.

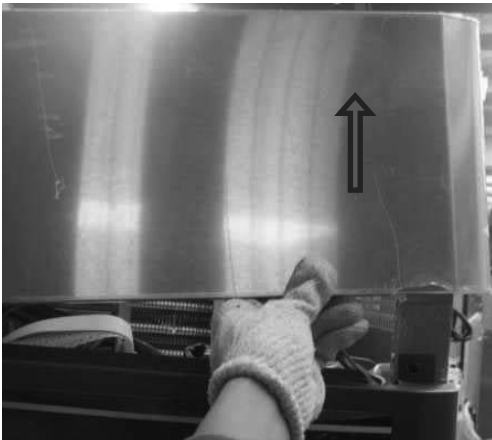

C. Unscrew screws on top grille (B).



D. Unscrew the screws located on the bottom of top grille (B).



E. Pull out the harness of the display PCB and the harness of the door s/w located on back of top grille (B).



REVERSIBLE DOOR INSTRUCTIONS

(For M3R-19-1 / M3R-24-1 / M3F-19-1 / M3F-24-1)

2.Replacing Door

- A. Unscrew screws located on top grille. (*Caution: When unscrewing, hold the top grille. Falling down top grille may cause bruise.)

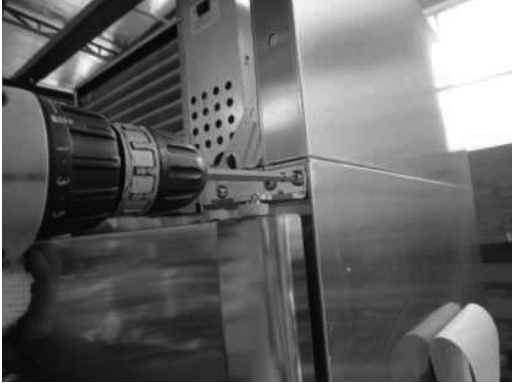

- B. Lift the door, then remove it°



- C. Disassemble the top hinge(left) and bottom hinge(left).



- D. Disassemble top hinge(right),then screw stopper plate on top hinge(right).



- E. Disassemble stopper plate which located on bottom hinge(right),then assemble bottom hinge(right) on position of top hinge(left)

REVERSIBLE DOOR INSTRUCTIONS

(For M3R-19-1 / M3R-24-1 / M3F-19-1 / M3F-24-1)

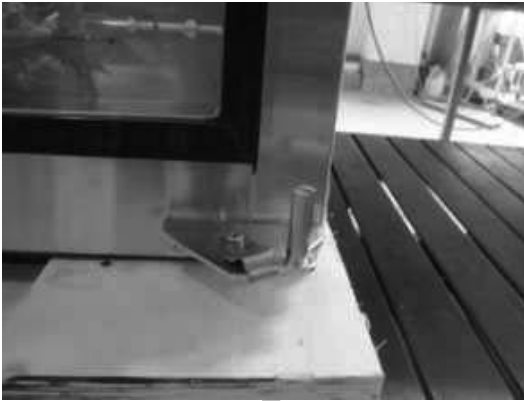

F. Disassemble stopper plate, then tight screws.



G. Assemble stopper plate in original positions.



H. Assemble the door, then rotate it about 180 degrees. Assemble top hinge (right) with stopper plate in bottom hinge (left) position. (First, assemble top hinge (left); second, assemble bottom hinge (left) while doors are closed, insert hinge into door bushing (left) with lifting, rotate doors counter-clockwise, screw hinge in original positions.)



REVERSIBLE DOOR INSTRUCTIONS

(For M3R-19-1 / M3R-24-1 / M3F-19-1 / M3F-24-1)

- I. Assemble top hinge (right) with fixtures in original positions.

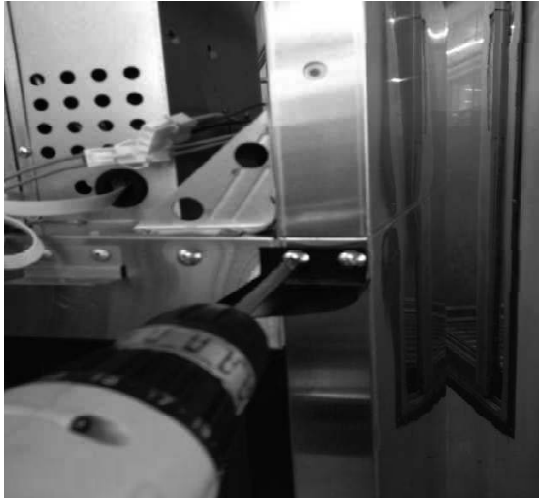

- J. Screw top grille (T) and top grille (B). (This process is opposite of disassembling).

TROUBLESHOOTING

SYMPTOMS	CAUSES	SOLUTIONS
Freezer is melting food.	<ul style="list-style-type: none"> • The controller is set too high to contain food fresh. 	<ul style="list-style-type: none"> • Turn the temperature dial to a warmer position.
The unit does not refrigerate at all.	<ul style="list-style-type: none"> • There is a power connection failure problem. 	<ul style="list-style-type: none"> • Check the power cord and plug in it correctly.
The unit does not refrigerate well.	<ul style="list-style-type: none"> • The unit is in sunlight or near a heating device. • The unit contains hot food or too much food. • The unit door is opened too frequently or left open long. • The temp. dial is not on the correct position. • The condenser is clogged. 	<ul style="list-style-type: none"> • Check the installation place. • Check the condition of stored food. • Check the position of the temp control dial.
There is a loud noise.	<ul style="list-style-type: none"> • The floor is too weak or the leveling feet is set incorrectly. • The back-side of the unit is too close to the wall. 	<ul style="list-style-type: none"> • Check the installation.
There are dew-drops on the unit exterior.	<ul style="list-style-type: none"> • High-moisture air can produce dewdrops during rainy season. 	<ul style="list-style-type: none"> • Wipe with a dry cloth.
There are dew-drops on the unit interior.	<ul style="list-style-type: none"> • The door is opened too frequently or left open long. • Damp food is stored. 	<ul style="list-style-type: none"> • Keep the door closed to remove dewdrops.
The door does not close tightly.	<ul style="list-style-type: none"> • The door is bent. • The unit is a levelling failure. • The door gasket has come out. 	<ul style="list-style-type: none"> • Level the unit again. • Reposition the gasket.

The following points are not malfunctions:

- A water-flowing sound can be heard when the compressor stops. This is the sound of REFRIGERANT flowing.
- The compressor does not run against defrosting function.

STAINLESS STEEL EQUIPMENT CARE AND CLEANING

CAUTION : Do not use any steel wool, abrasive or chlorine based products to clean stainless steel surfaces.

Stainless Steel Opponents

There are three basic things which can break down your stainless steel's passivity layer and allow corrosion to rear its ugly head.

- 1) Scratches from wire brushes, scrapers, and steel pads are just a few examples of items that can be abrasive to stainless steel's surface.
- 2) Deposits left on your stainless steel can leave spots. You may have hard or soft water depending on what part of the country you live in. Hard water can leave spots. Hard water that is heated can leave deposits if left to sit too long. These deposits can cause the passive layer to break down and rust your stainless steel. All deposits left from food prep or service should be removed as soon as possible.
- 3) Chlorides are present in table salt, food, and water. Household and industrial cleaners are the worst type of chlorides to use.

8 step that can help prevent rust on stainless steel:

1. Using the correct cleaning tools

Use non-abrasive tools when cleaning your stainless steel products. The stainless steel's passive layer will not be harmed by soft cloths and plastic scouring pads. Step 2 tells you how to find the polishing marks.

2. Cleaning along the polish lines

Polishing lines or "grain" are visible on some stainless steels. Always scrub parallel to visible lines on some stainless steels. Use a plastic scouring pad or soft cloth when you cannot see the grain.

3. Use alkaline, alkaline chlorinated or non-chloride containing cleaners

While many traditional cleaners are loaded with chlorides, the industry is providing an ever increasing choice of non-chloride cleaners. If you are not sure of your cleaners chloride content contact your cleaner supplier. If they tell you that your present cleaner contains chlorides, ask if they have an alternative. Avoid cleaners containing quaternary salts as they can attack stainless steel, causing pitting and rusting.

4. Water Treatment

To reduce deposits, soften the hard water when possible. Installation of certain filters can remove corrosive and distasteful elements. Salts in a properly maintained water softener can be to your advantage. Contact a treatment specialist if you are not sure of the proper water treatment.

5. Maintaining the cleanliness of your food equipment

Use cleaners at recommended strength (alkaline, alkaline chlorinated or non-chloride). Avoid build-up of hard stains by cleaning frequently. When boiling water with your stainless steel equipment, the single most likely cause of damage is chlorides in the water. Heating nay cleaners containing chlorides will have the same damaging effects.

6. Rinse

When using chlorinated cleaners you must rinse and wipe dry immediately. It is better to wipe standing cleaning agents and water as soon as possible. Allow the stainless steel equipment to air dry. Oxygen helps maintain the passivity film on stainless steel.

7. Hydrochloric acid (muriatic acid) should never be used on stainless steel.

8. Regularly restore/passivate stainless steel.

Recommended cleaners for certain situation/environments of stainless steel.

- A) Soap, ammonia and detergent medallion applied with a cloth or sponge can be used for routine cleaning.
- B) Arcal 20, Lac-O-Nu Ecoshine applied provides barrier film for fingerprints and smears.
- C) Cameo, Talc, Zud First Impression is applied by rubbing in the direction of the polished lines for stubborn stains and discoloring.
- D) Easy-off and De-Grease it oven aid are excellent for removals on all finishes for grease-fatty acids, blood and burnt-on foods.
- E) Any good commercial detergent can be applied with a sponge or cloth to remove grease and oil.
- F) Benefit, Super Sheen, Sheila Shine are good for restoration/passivation.

THREE YEAR WARRANTY

Turbo Air warrants to the original purchaser of every new Turbo Air refrigerated unit, the cabinet and all parts thereof, to be free from defects in material or workmanship, under normal use and service, for a period of three (3) year from the date of original installation or 39 months after shipment date from Turbo Air , whichever occurs first.

Any parts covered by this warranty that are examined and determined by Turbo Air to have been defective within three (3) year of original installation or thirty nine (39) months after shipment date from manufacturer, whichever occurs first, shall be repaired or replaced as stated below. Turbo Air shall be deemed to have fully complied with its obligation under the foregoing warranties by electing either one of the following procedures, at the sole discretion of Turbo Air.

1. Furnishing a replacement part, freight collect, in even exchange for the returned part, freight collect.
2. Receiving the defective part, freight collect; repairing it; and returning it, freight collect.

ADDITIONAL TWO YEAR COMPRESSOR WARRANTY

In addition to the three (3) year warranty stated above, Turbo Air warrants its hermetically and semi-hermetically sealed compressor to be free from defects in both material and workmanship under normal use and service for a period of two (2) additional years from the date of original installation but not to exceed five (5) years and three (3) months after shipment from manufacturer.

Compressors determined by Turbo Air have been defective within this extended time period will, at Turbo' Air s option, be either repaired or replaced with a compressor or compressor parts of similar design and capacity.

The two (2) year extended compressor warranty applies only to hermetically and semi-hermetically sealed parts of the compressor and does not apply to any other parts or components, including, but not limited to, cabinet, paint finish, temperature control, refrigerant, metering device, driers, motor starting equipment, fan assembly any other electrical component, etcetera.

134A(404A) COMPRESSOR WARRANTY

The five year compressor warranty detailed above will be voided if the following procedure is not carefully adhered to:

1. This system contains R134A refrigerant and polyol ester lubricant. The Polyol ester lubricant has rapid moisture absorbing qualities. If long exposure to the ambient conditions occur, the lubricant must be removed and replaced with new. Listed below are the approved lubricants for the Tecumseh compressors.

- 1 ICI-Emkarate RL 184
- 2 Emery-2927-A
- 3 Mobile Artic 22A

Failure to comply with recommended lubricant specification will void the compressor warranty.

2. Dryer replacement is very important and must be changed when a system is opened for servicing. dryer must be used with XH-9 desiccant.
3. Micron level vacuums must be achieved to insure low moisture levels in the system. 500 microns or lower must obtained.

What is NOT covered by this warranty

Turbo Air's sole obligation under this warranty is limited to either repair or replacement of parts, subject to the additional limitations below. This warranty neither assumes nor authorizes any person to assume obligations other than expressly covered by this warranty.

1. **WARRANTY IS NOT TRANSFERABLE.** This warranty is not assignable and applies only in favor of the original purchaser/user to whom delivered. ANY SUCH ASSIGNMENT OR TRANSFER SHALL VOID THE WARRANTIES HEREIN MADE AND SHALL VOID ALL WARRANTIES, EXPRESS OR IMPLIED, INCLUDING ANY WARRANTY OF MERCHANTABILITY OR FITNESS FOR A PARTICULAR PURPOSE.
2. **NO CONSEQUENTIAL DAMAGES.** TURBO AIR IS NOT RESPONSIBLE FOR ECONOMIC LOSS; PROFIT LOSS OR SPECIAL, INDIRECT, OR CONSEQUENTIAL DAMAGES, INCLUDING WITHOUT LIMITATION, LOSSES OR DAMAGES ARISING FROM FOOD OR PRODUCT SPOILAGE CLAIMS WHETHER OR NOT ON ACCOUNT OF REFRIGERATION FAILURE.
3. **ALTERATION, NEGLIGENCE, ABUSE, MISUSE, ACCIDENT, DAMAGE DURING TRANSIT OR INSTALLATION, FIRE, FLOOD, ACTS OF GOD.** TURBO AIR is not responsible for the repair or replacement of any parts that Turbo Air determines have been subjected after the date of manufacture to alteration, neglect, abuse, misuse, accident, damage during transit or installation, fire, flood, or an Act of God.
4. **NO IMPLIED WARRANTY OF MERCHANTABILITY OR FITNESS FOR A PARTICULAR PURPOSE.** THERE ARE NO OTHER WARRANTIES, EXPRESS, IMPLIED OR STATUTORY, EXCEPT THE THREE(3) YEAR WARRANTY AND THE ADDITIONAL TWO(2) YEAR COMPRESSOR WARRANTY AS DESCRIBED ABOVE. THESE WARRANTIES ARE EXCLUSIVE AND IN LIEU OF ALL OTHER WARRANTIES, INCLUDING IMPLIED WARRANTY AND MERCHANTABILITY OR FITNESS FOR A PARTICULAR PURPOSE. THERE ARE NO WARRANTIES WHICH EXTEND BEYOND THE DESCRIPTION ON THE FACE HEREOF.
5. **TRANSPORTATION COSTS.** Turbo Air will accept parts covered under this warranty freight collect, provided that shipment has received prior approval. Turbo Air is not responsible for any other transportation costs, but will ship freight collect parts either repaired or replaced under these warranties.
6. **WARRANTY CLAIMS.** All claims should include: model number of the cooler, the serial number of the cabinet, proof of purchase, date of installation, and all pertinent information supporting the existence of the alleged defect. Any action or breach of these warranty provisions must be commenced within three (3) year after that cause of action has accrued.

Turbo air REFRIGERATOR MANUFACTURER

4184 E. Conant St.
Long Beach, CA 90808
TEL : 310-900-1000
FAX : 310-900-1077
TOLL FREE : 1-800-627-0032
(U.S.A. & Canada)
Website : www.turboairinc.com

Warranty Claims...

All claims for parts or labor must be made directly through Turbo Air.

All claims should include: model number of the unit, the serial number of the cabinet, proof of purchase, date of installation, and all pertinent information supporting the alleged defect.

In case of compressor replacement under warranty, either compressor or compressor tag must be returned to Turbo Air along with above listed information.

Failure to comply with warranty policies will result in voiding claims.

Three Year Parts & Labor Warranty...

Turbo Air warrants all new refrigerated components, the cabinet and all parts, to be free from defects in materials or workmanship, under normal and proper use and maintenance service as specified by Turbo Air and upon proper installation and start-up in accordance with the instruction packet supplied with each Turbo air unit. Turbo Air's obligation under this warranty is limited to a period of three (3) year from the date of original installation or 39 months after shipment date from Turbo Air, whichever occurs first.

Any part, covered under this warranty, that are by Turbo Air to have been defective within three (3) year of original installation or thirty-nine (39) months after shipment date from manufacturer, whichever occurs first, is limited to the repair or replacement, including labor charges, of defective parts or assemblies. The labor warranty shall include standard straight time labor charges only and reasonable travel time, as determined by Turbo Air.

Additional Two Year Compressor Warranty...

In addition to the three (3) year warranty stated above, Turbo Air warrants its hermetically sealed compressor to be free from defects in both material and workmanship under normal and proper use and maintenance service for a period of two (2) additional years from the date of original installation, but not to exceed five (5) years and three(3) months after shipment from the manufacturer.

Compressor determined by Turbo Air to have been defective within this extended period will, at Turbo Air's discretion, be either repaired or replaced with a compressor or compressor parts of similar design and capacity.

The two (2) year extended compressor warranty applies only to hermetically sealed parts of the compressor and does not apply to any other parts or components, including, but not limited to, cabinet, paint finish, temperature control, refrigerant, metering device, driers, motor starting equipment, fan assembly or and other electrical components, etcetera.

404A / 134a Compressor Warranty...

The five-year compressor warranty detailed above will be void if the following procedure is not carefully adhered to:

1. This system contains R404A or R134a refrigerant and polyol ester lubricant. The polyol ester lubricant has rapid moisture absorbing qualities.
2. Drier replacement is very important and must be changed when a system is opened for servicing. A620 copper drier or better is highly recommended.
3. Micron level vacuums must be achieved to insure low moisture levels in the system. 500 microns or lower must be obtained.
4. When compressor is grounded, suction drier and 620 drier or better must be replaced.
5. Compressor must be obtained through Turbo Air, unless otherwise specified in writing, through Turbo Air's warranty department.

404A / 134a Compressor Warranty...

Turbo Air's sole obligation under this warranty is limited to either repair or replacement of parts, subject to the additional limitations below. This warranty neither assumes nor authorizes any person to assume obligations other than those expressly covered by this warranty.

NO CONSEQUENTIAL DAMAGES. TURBO AIR IS NOT RESPONSIBLE FOR ECONOMIC LOSS; PROFIT LOSS; OR SPECIAL, INDIRECT, OR CONSEQUENTIAL DAMAGES, INCLUDING WITHOUT LIMITATION, LOSSES, OR DAMAGES ARISING FROM FOOD OR PRODUCT SPOILAGE REGARDLESS OF WHETHER OR NOT THEY RESULT FROM REFRIGERATION FAILURE. WARRANTY IS NOT TRANSFERABLE, This warranty is not assignable and applies only in favor of the original purchaser/user to whom delivered. ANY SUCH ASSIGNMENT OR TRANSFER SHALL VOID THE WARRANTIES HEREIN AND SHALL VOID ALL WARRANTIES, EXPRESS OR IMPLIED, INCLUDING ANY WARRANTY OF MERCHANTABILITY OR LABOR COVERAGE FOR COMPONENT FAILURE OR OTHER THE WARRANTY PACKET PROVIDED WITH THE UNIT. ALTERATION, NEGLIGENCE, ABUSE, MISUSE, ACCIDENT, DAMAGE DURING TRANSIT OR INSTALLATION, FIRE, FLOOD, ACTS OF GOD. Turbo Air is not responsible for the repair or replacement of any parts that Turbo Air determines have been subjected after the date of manufacture to alteration, neglect, abuse, misuse, accident, damage during transit or installation, fire, flood, or act of GOD. IMPROPER ELECTRICAL CONNECTIONS. TURBO AIR IS NOT RESPONSIBLE FOR THE REPAIR OR REPLACEMENT OF FAILED OR DAMAGED COMPONENTS RESULTING FROM ELECTRICAL POWER FAILURE, THE USE OF EXTENSION CORDS, LOW VOLTAGE, OR VOLTAGE DROPS TO THE UNIT. NO IMPLIED WARRANTY OF MERCHANTABILITY OR FITNESS FOR A PARTICULAR PURPOSE; THERE ARE NO OTHER WARRANTIES, EXPRESSED, IMPLIED OR STATUTORY, EXCEPT THE THREE (3) YEAR PARTS & LABOR WARRANTY AND THE ADDITIONAL TWO (2) YEAR COMPRESSOR WARRANTY AS DESCRIBED ABOVE. THESE WARRANTIES ARE EXCLUSIVE AND IN LIEU OF ALL OTHER WARRANTIES, INCLUDING IMPLIED WARRANTY AND MERCHANTABILITY OR FITNESS FOR A PARTICULAR PURPOSE. THERE ARE NO WARRANTIES, WHICH EXTEND BEYOND THE DESCRIPTION ON THE FACE HEREOF.

Outside U.S. and Canada; This warranty does not apply to, and Turbo Air is not responsible for, any warranty claims made on products sold or used outside the continent of the United States and Canada.