

CAUTION!
PLEASE KEEP POWER
SWITCH ON BEFORE
OPERATING THIS EQUIPMENT

Commercial Refrigerator & Freezer Service Manual

Please read this manual completely before attempting to install or operate this equipment!

SOLID DOOR

TSR-23SD*	TSF-23SD
TSR-35SD	TSF-35SD
TSR-49SD	TSF-49SD
TSR-72SD	TSF-72SD

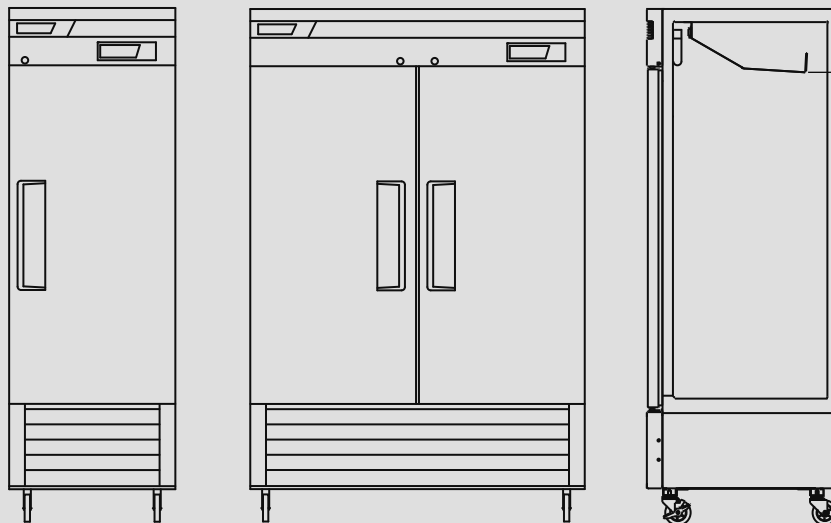

TABLE OF CONTENTS

1. FEATURE CHART

- 1-1. FRONT VIEW
- 1-2. SIDE VIEW

2. WIRING DIAGRAM

- 2-1. REFRIGERATOR (1DOOR) : TSR-23SD
- 2-2. FREEZER (1DOOR) : TSF-23SD
- 2-3. REFRIGERATOR (2DOOR) : TSR-49SD
- 2-4. FREEZER (2DOOR) : TSF-49SD
- 2-5. REFRIGERATOR (3DOOR) : TSR-72SD
- 2-6. FREEZER (3DOOR) : TSF-72SD

3. PART DETAILS

- 3-1. TOP GRILLE
- 3-2. REFRIGERATION COMPARTMENT
- 3-3. ELECTRICAL BOX
- 3-4. DOOR
- 3-5. COOLING COMPARTMENT

4. MAIN COMPONENTS

- 4-1. COMPRESSOR
- 4-2. COMPRESSOR RELAY
- 4-3. CONDENSER DRYER
- 4-4. CAPACITOR
- 4-5. EVA FAN MOTOR
- 4-6. CONDENSOR FAN MOTOR
- 4-7. EVA DEFROST HEATER
- 4-8. LAMP
- 4-9. PCB TRANSFORMER
- 4-10. MAIN PCB

5. ELECTRONIC CONTROLLER INSTRUCTION

- 5-1. FREEZER CONTROLLER
 - 5-1-1. HOW TO USE THE PANEL
 - 5-1-2. FUNCTION TABLE
 - 5-1-3. ERROR CODE TABLE
- 5-2. REFRIGERATOR CONTROLLER
 - 5-2-1. HOW TO USE THE PANEL
 - 5-2-2. FUNCTION TABLE
 - 5-2-3. ERROR CODE TABLE

6. SPARE PARTS LIST

7. REPLACEMENT OF MAIN COMPONENTS

- 7-1. TOP GRILLE PARTS
- 7-2. REPLACING DOOR
- 7-3. REFRIGERATION COMPARTMENT'S PARTS
- 7-4. CONDENSING UNIT
- 7-5. REPLACING CABINET FRAME HEATER (AND/OR) MULLION HEATER

1. FEATURE CHART

1-1. FRONT VIEW

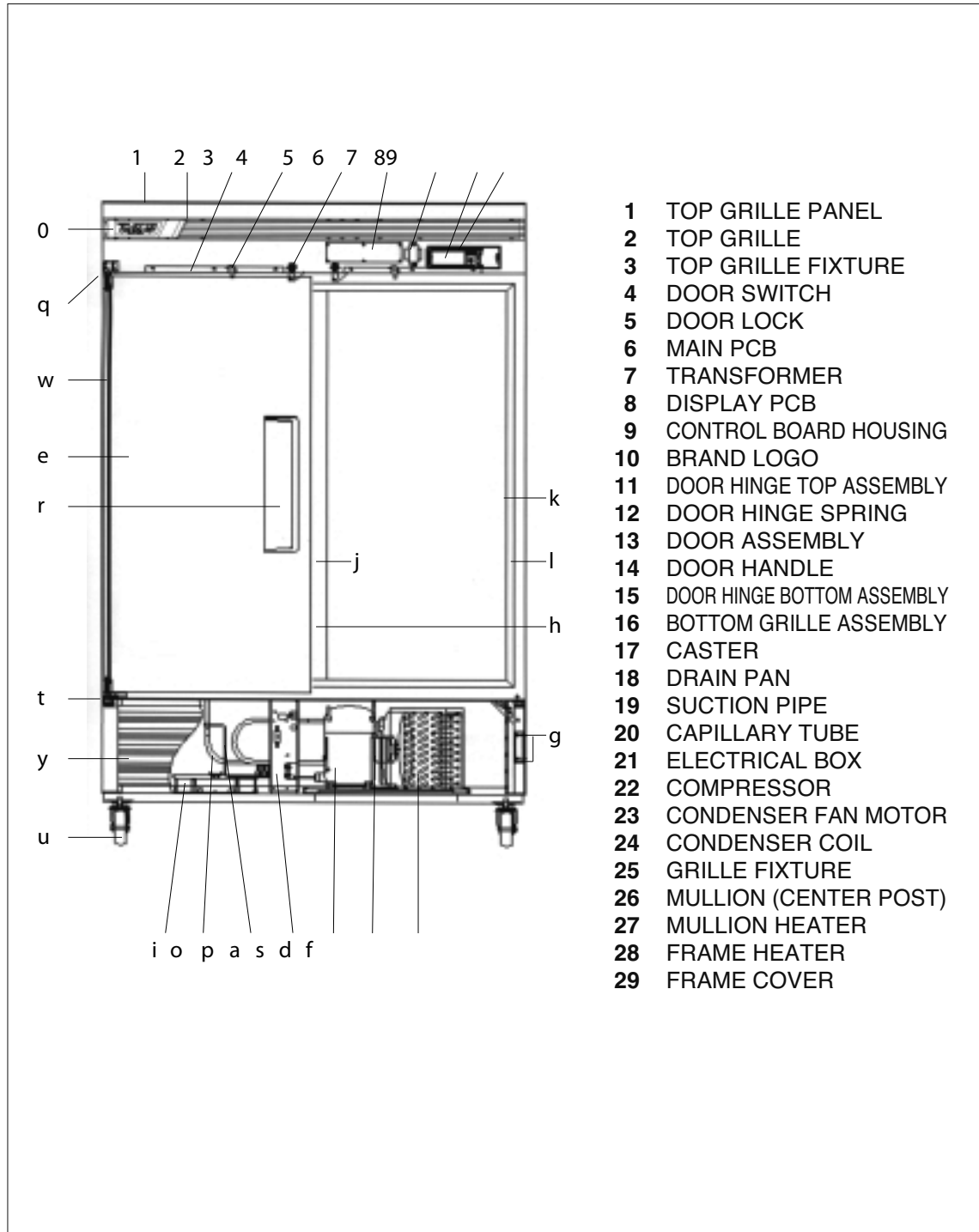

FEATURE CHART

1-2. SIDE VIEW

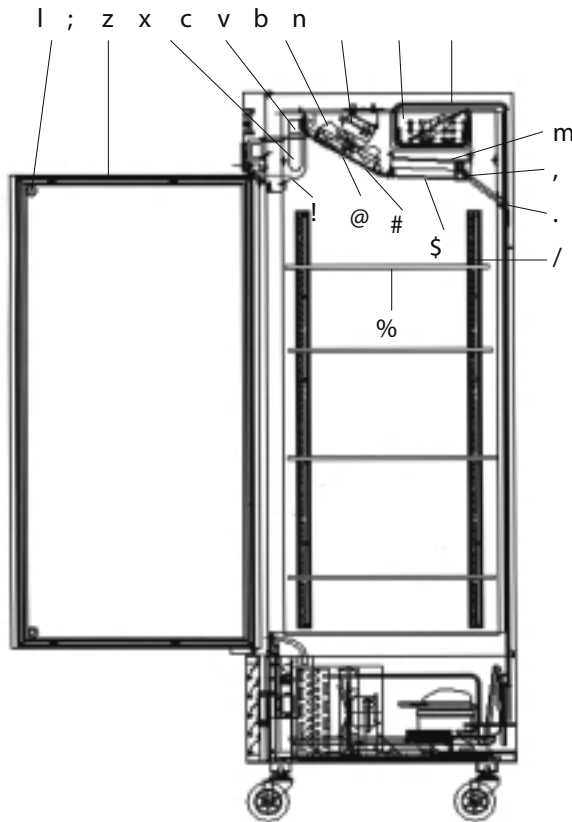

- 29** DOOR BUMPER
- 30** DOOR GASKET
- 31** LAMP BULB
- 32** LAMP SOCKET
- 33** EVAPORATOR FAN MOTOR BLADE
- 34** EVAPORATOR FAN MOTOR
- 35** EVAPORATOR COIL
- 36** SUCTION PIPE
- 37** EVAPORATOR DRAIN PAN
- 38** EVAPORATOR DRAIN ELBOW
- 39** DRAIN HOSE
- 40** SHELF STANDARD
- 41** LAMP SHIELD
- 42** EVAPORATOR FAN MOTOR GUARD
- 43** DUCT (A) 'FRONT'
- 44** DUCT (B) 'BOTTOM'
- 45** SHELF

2. WIRING DIAGRAM

2-1. TSR-23SD

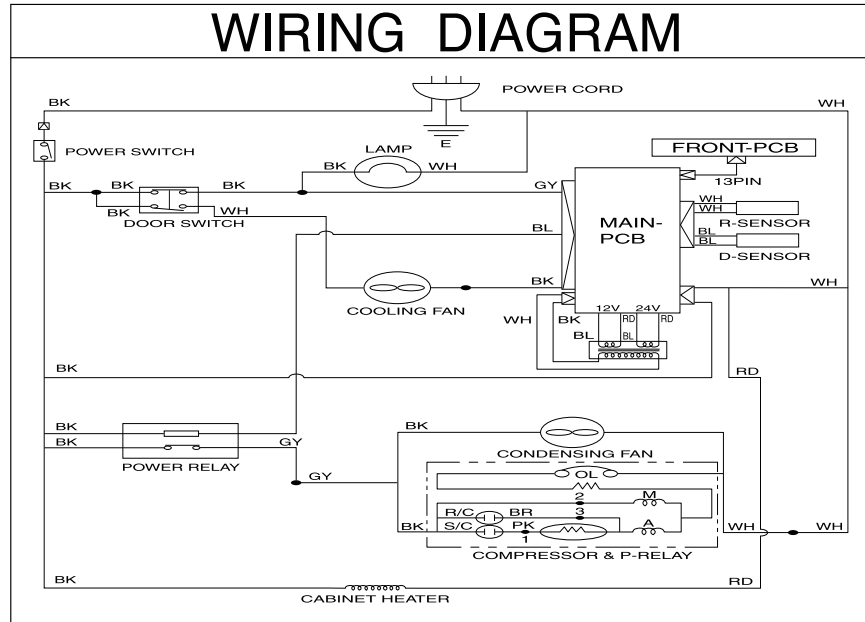

2-2. TSF-23SD

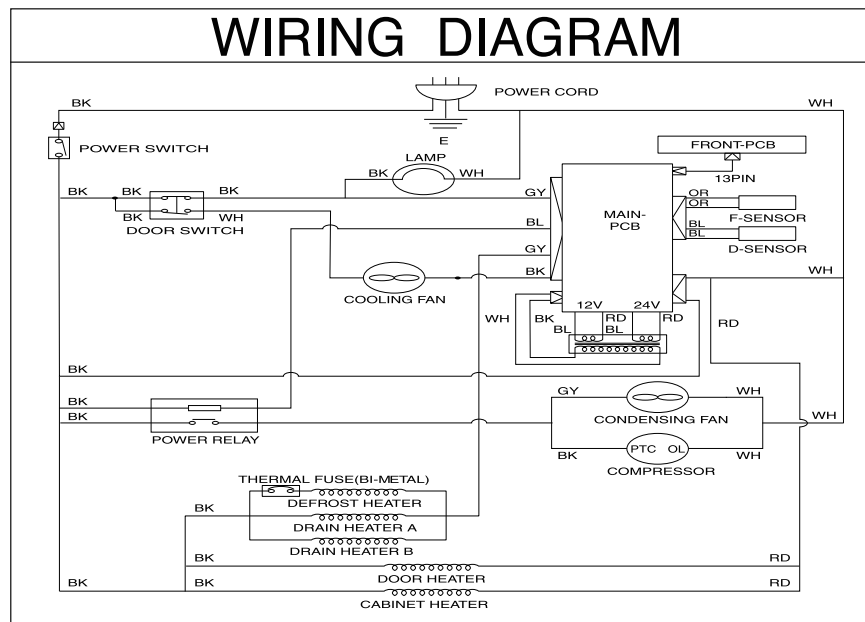

WIRING DIAGRAM

2-3. TSR-49SD

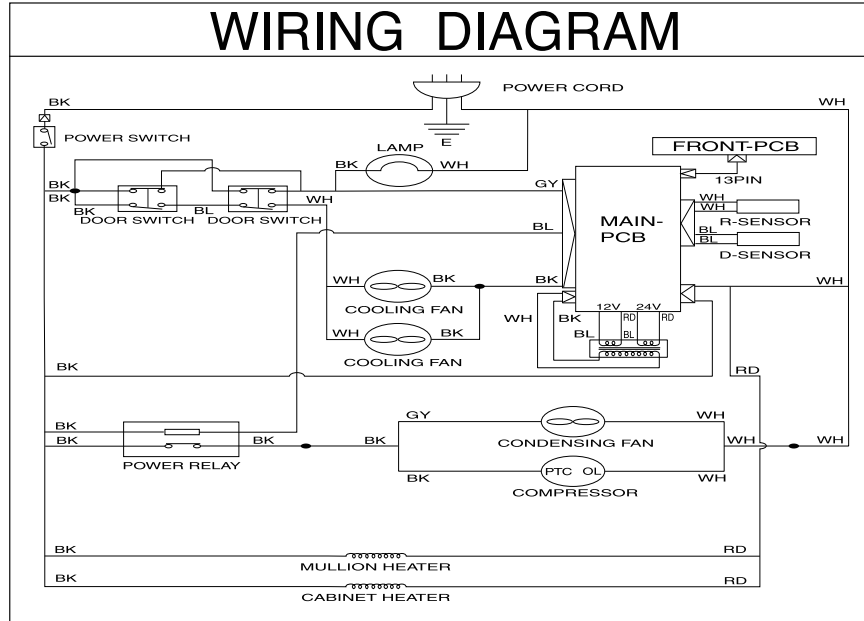

2-4. TSF-49SD

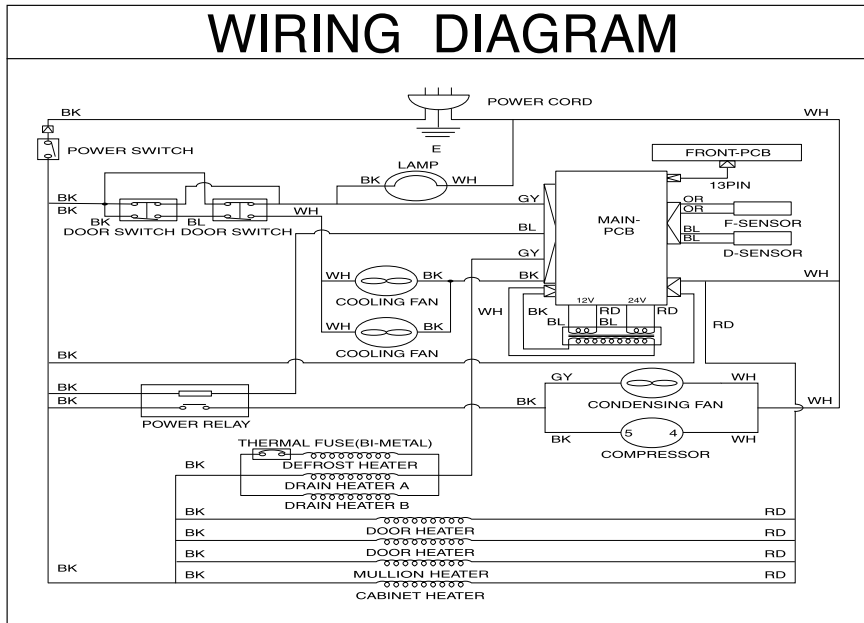

WIRING DIAGRAM

2-5. TSR-72SD

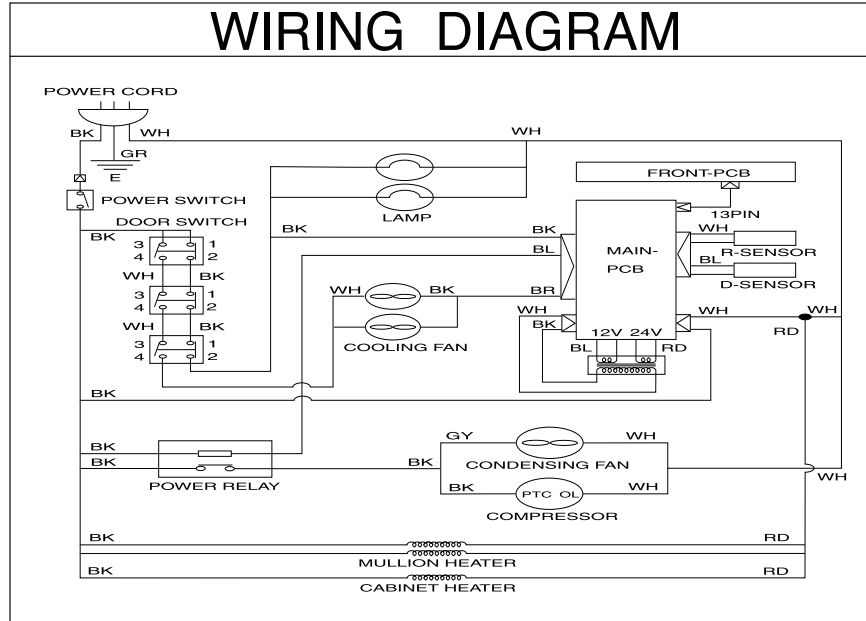

2-6. TSF-72SD

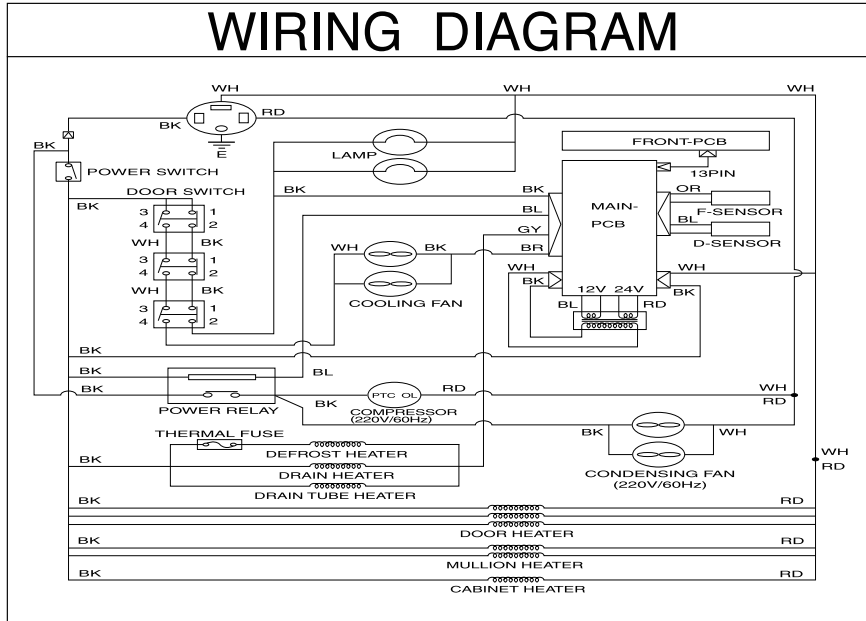

3. PART DETAILS

3-1. TOP GRILLE

Door Lock, Switch



Transformer, Main P.C.B

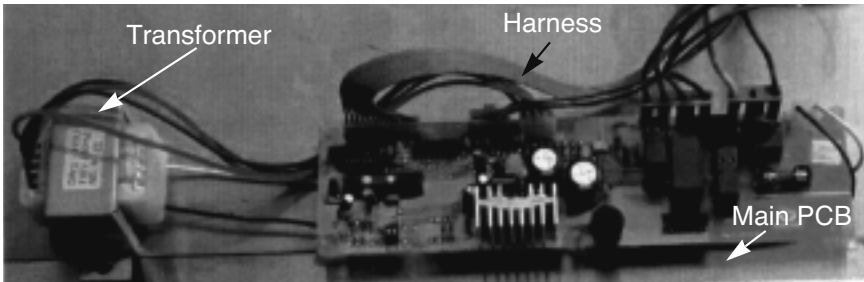

3-2. Refrigeration Compartment

Cycle Assembly

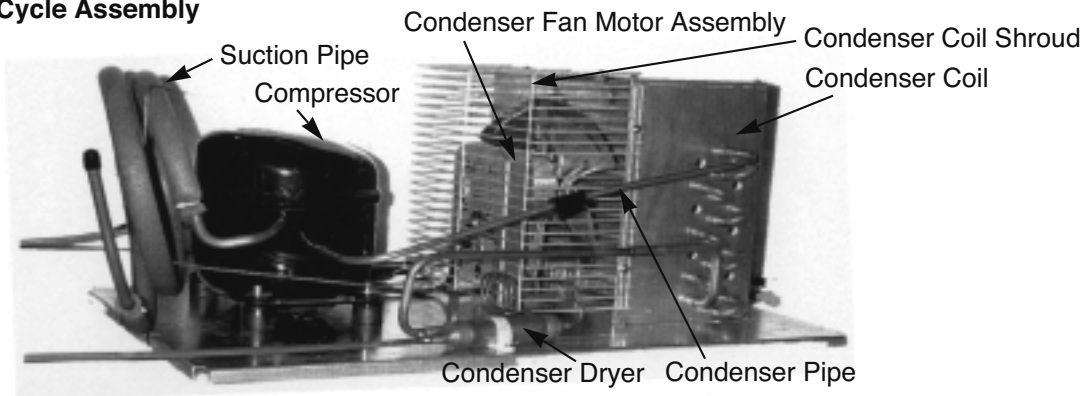

PART DETAILS

Drain Pan Assembly

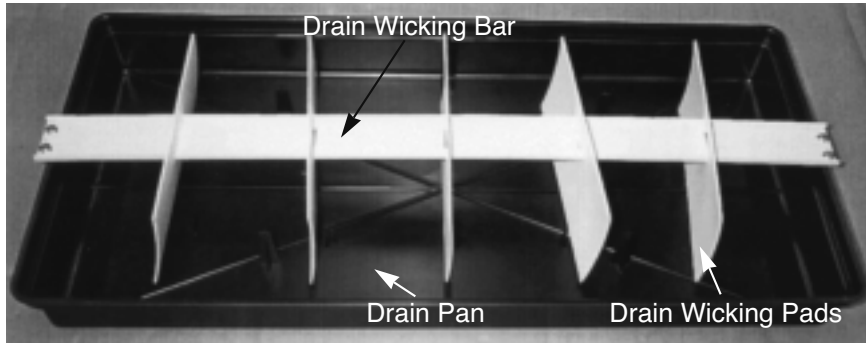

Condenser Fan Motor Assembly

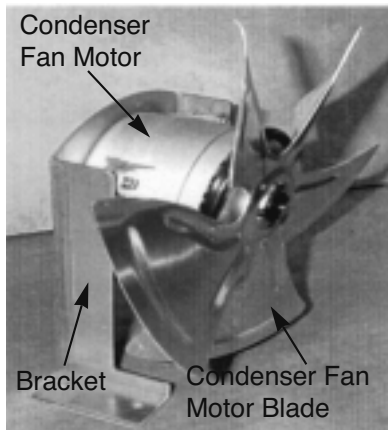

3-3. Electrical Box

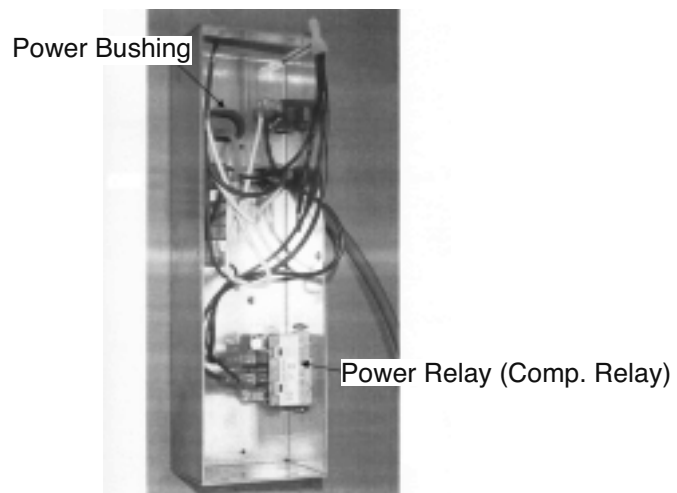

3-4. Door

Gasket

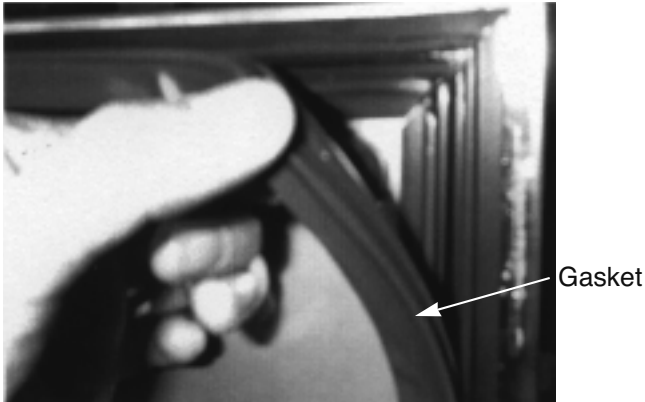

3-5. Cooling Compartment

Freezer Duct & Refrigerator Duct (TSR-49SD, TSF-49SD, TSR-72SD, TSF-72SD Type)

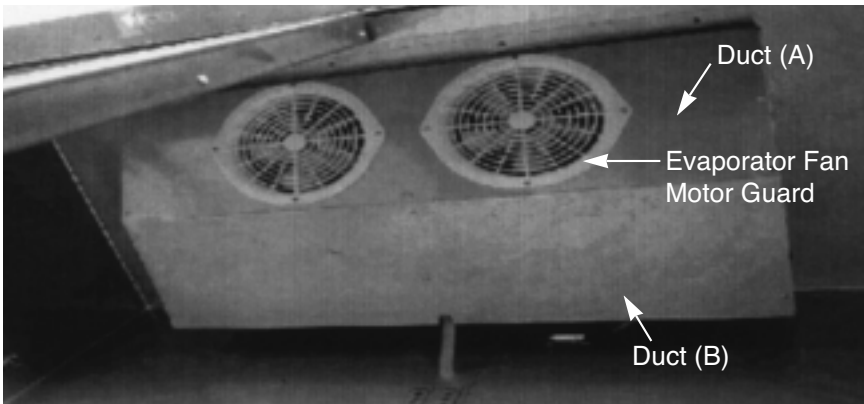

Freezer Evaporator, Fan (TSF-49SD, TSF-72SD)

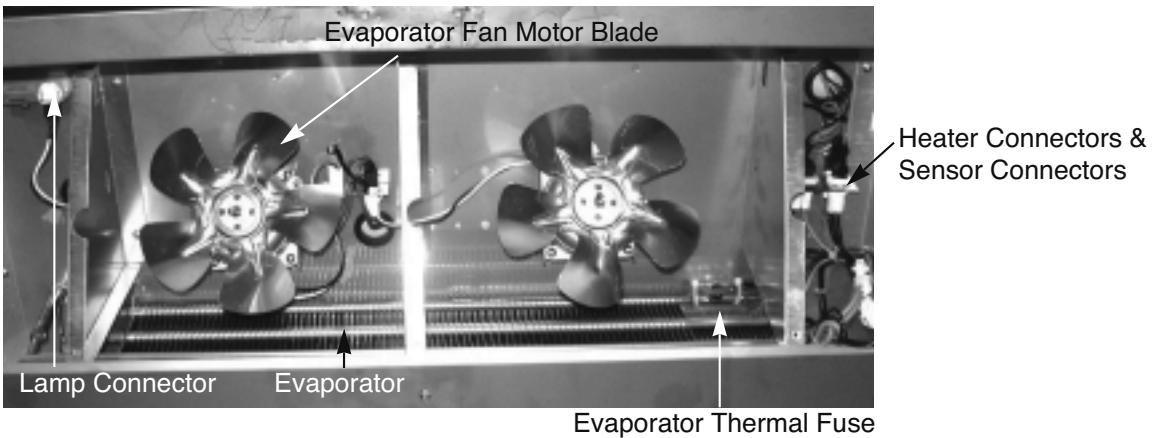

PART DETAILS

Freezer Duct & Refrigerator Duct (TSR-23SD, TSF-23SD Type)

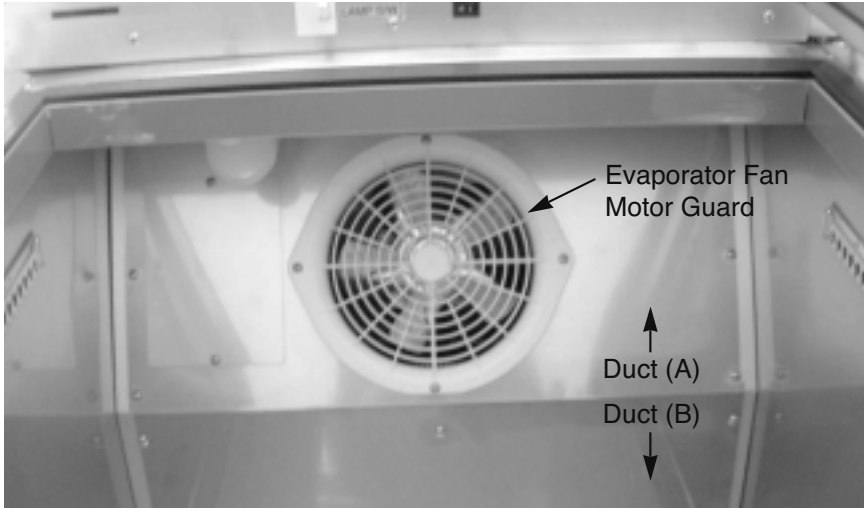

Freezer Evaporator, Fan (TSF-23SD)

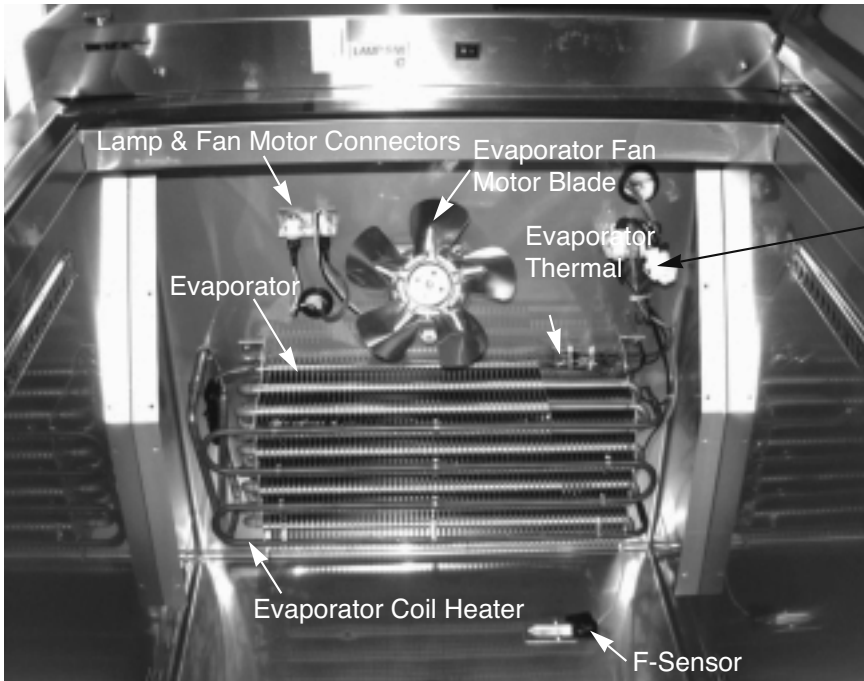

4. MAIN COMPONENTS

4-1. COMPRESSOR

Model	TSR-23SD	TSR-49SD	TSF-23SD	TSF-49SD	TSR-72SD	TSF-72SD
Refrigerant	R-134a		R-404a		R-134a	R-404a
Voltage	115V / 60Hz					208/230
Comp. Model	HBL27YE-1	SK6A1C-H2Y	AEA2411ZXA	AJA2425ZXA	AKA4476YXA	CAJ2446Z
Part code	3952127G10	3020014540	30200L0100	30200L0200	30200A4700	30206Q3600
Strating type	CSR	RSIR	CSIR	CSIR	CSIR	CSR

4-2. COMPRESSOR RELAY

Model	TSR-23SD	TSR-49SD	TSF-23SD	TSF-49SD	TSR-72SD	TSF-72SD
Voltage	115V / 60Hz					220V/60Hz
Relay Model	783RHBZZ-52	4TM811XHB-53	8300MRTL13	8300CRAN04	8300MRAM53	3ARR3-3A3A

4-3. CONDENSER DRYER

Model	TSR-23SD	TSR-49SD	TSF-23SD	TSF-49SD	TSR-72SD	TSF-72SD
Refrigerant	R-134a		R-404a		R-134a	R-404a
Spec.	XH-9(50g)					
Part code	30268L0300		30268L0400		30268Q0100	30268Q0210

4-4. CAPACITOR

Model	TSR-23SD	TSR-49SD	TSF-23SD	TSF-49SD	TSR-72SD	TSF-72SD
Voltage	115V / 60Hz					220V/60Hz
Running	230V/10uF	x	x	370V/15uF	x	440V/15μF
Part code	400EL15130	Comp.Assembly				
Starting	200V/100uF	x	165V/270~324uF	330V/161~193uF	378~445MFD	260V/88μF
Part code	401RD35050	Comp.Assembly				

MAIN COMPONENTS

4-5. EVA FAN MOTOR

Model	TSR-23SD	TSR-49SD	TSF-23SD	TSF-49SD	TSR-72SD	TSF-72SD
Voltage	115V / 60Hz					
Motor Model	IS4420DWSN-2A					
Part code	3963328120					

4-6. CONDENSOR FAN MOTOR

Model	TSR-23SD	TSR-49SD	TSF-23SD	TSF-49SD	TSR-72SD	TSF-72SD
Voltage	115V / 60Hz					220V/60Hz
Motor Model	IS4420DWSG-1					IS4420DWSQ-1
Part code	3963220410					3963322020

4-7. EVA DEFROST HEATER

Model	TSR-23SD	TSR-49SD	TSF-23SD	TSF-49SD	TSR-72SD	TSF-72SD
Voltage	115V / 60Hz					
Spec.	x		445W	600W	x	900W
Part code	x		30228L0802	30228L0700	x	30228Q0600

4-8. LAMP BULB

Model	TSR-23SD	TSR-49SD	TSF-23SD	TSF-49SD	TSR-72SD	TSF-72SD
Voltage	120V / 60Hz					
Spec.	25W					
Part code	30236L0100					

4-9. TRANSFORMER

Model	TSR-23SD	TSR-49SD	TSF-23SD	TSF-49SD	TSR-72SD	TSF-72SD
Voltage	115V / 60Hz					
Spec.	DWS-115U					
Part code	30284L0100					

4-10. MAIN PCB

Model	TSR-23SD	TSR-49SD	TSF-23SD	TSF-49SD	TSR-72SD	TSF-72SD
Voltage	115V / 60Hz					
Part code	30243L0310		30243L0200	30243L0300	30243L0310	30243Q0300
Micom code	1RF1151		1FF1153	2FF1153	1RF1151	3FF1151

* Last digit of micom code represents micom version.

5. ELECTRONIC CONTROLLER INSTRUCTION

5-1. FREEZER CONTROLLER

5-1-1. HOW TO USE THE PANEL

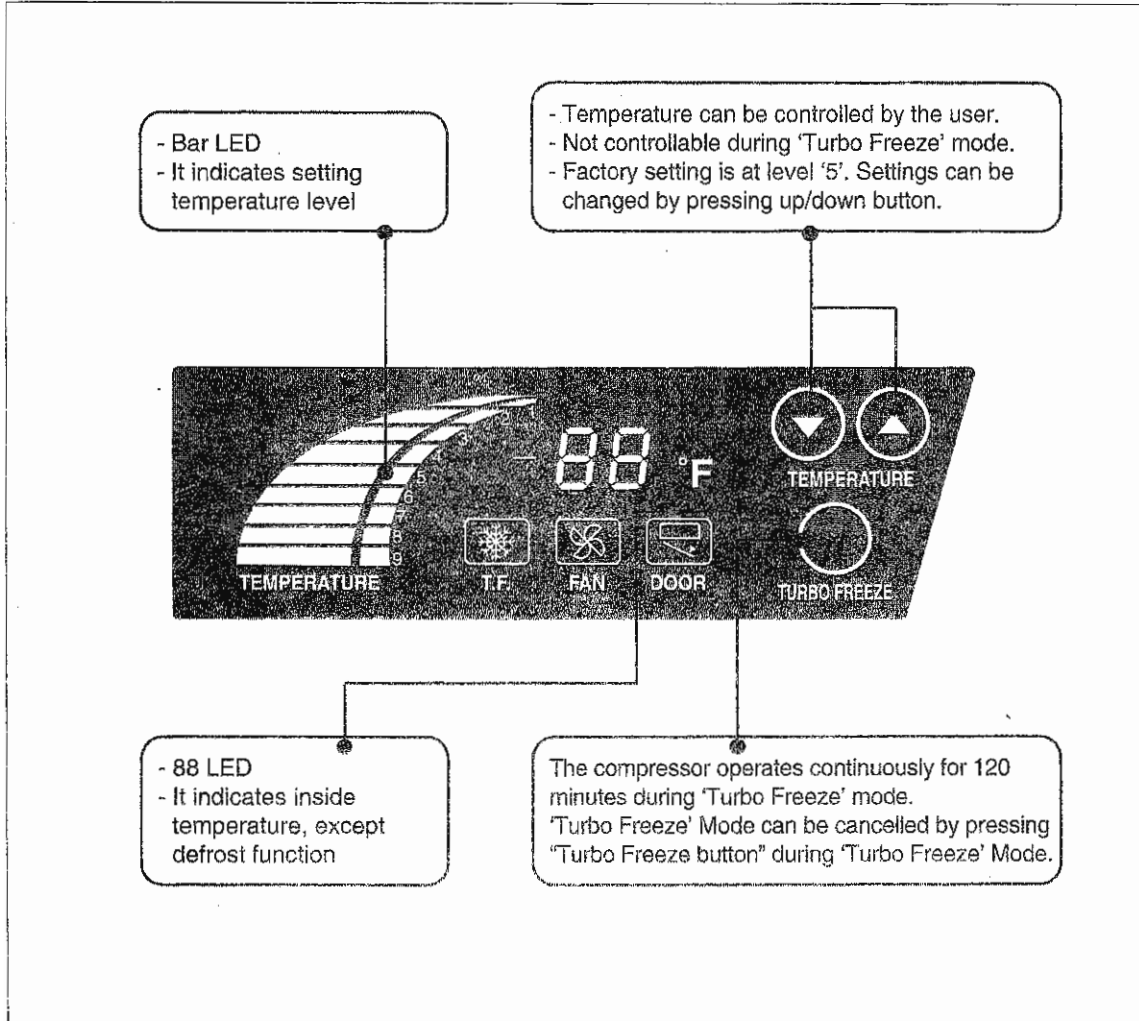

ELECTRONIC CONTROLLER INSTRUCTION

5-1-2. FUNCTION TABLE

No	Function	Controlled Part	Description																																																																																																																																																																																																								
1	Initial Operation	Buzzer, Fan or Door Lamp Bar LED 88 LED	<ol style="list-style-type: none"> Buzzer will ring 2 sec. after Plug-In. 88 LED displays inside temperature. Compressor runs immediately, if evaporator temperature is higher than 38.3°F(3.5°C). Compressor will run 3 minutes after plug-in, if eva. temp is lower than 38.3°F(3.5°C). 																																																																																																																																																																																																								
2	Temperature Control	Compressor F-fan C-fan LED	<ol style="list-style-type: none"> The temperature can be changed by pushing up/down buttons. 88 LED displays inside temperature. Buzzer buzzes 1 time whenever a button is pressed. Compressor automatically turns on and off by F-sensor (Except error mode) After Comp. is off, comp. will not start for 3 min. even though the F-sensor is at on point. F-fan goes off when comp. goes off or door is opened. F-fan will start 3 sec. after door is closed(when comp. is running). Comp. on/off temperature(°F). <table border="1"> <thead> <tr> <th>°C</th> <th>1</th> <th>2</th> <th>3</th> <th>4</th> <th>5</th> <th>6</th> <th>7</th> <th>8</th> <th>9</th> </tr> </thead> <tbody> <tr> <td>1 Door On</td> <td>-14.0</td> <td>-15.0</td> <td>-16.0</td> <td>-17.0</td> <td>-18.0</td> <td>-19.0</td> <td>-20.0</td> <td>-21.0</td> <td>-22.0</td> </tr> <tr> <td>Off</td> <td>-18.0</td> <td>-19.0</td> <td>-20.0</td> <td>-21.0</td> <td>-22.0</td> <td>-23.0</td> <td>-24.0</td> <td>-25.0</td> <td>-26.0</td> </tr> <tr> <td>ΔT</td> <td>4.0</td> <td>4.0</td> <td>4.0</td> <td>4.0</td> <td>4.0</td> <td>4.0</td> <td>4.0</td> <td>4.0</td> <td>4.0</td> </tr> <tr> <td>2 Door On</td> <td>-12.5</td> <td>-13.5</td> <td>-14.5</td> <td>-15.5</td> <td>-16.5</td> <td>-17.5</td> <td>-18.5</td> <td>-19.5</td> <td>-20.5</td> </tr> <tr> <td>Off</td> <td>-16.0</td> <td>-17.0</td> <td>-18.0</td> <td>-19.0</td> <td>-20.0</td> <td>-21.0</td> <td>-22.0</td> <td>-23.0</td> <td>-24.0</td> </tr> <tr> <td>ΔT</td> <td>3.5</td> <td>3.5</td> <td>3.5</td> <td>3.5</td> <td>3.5</td> <td>3.5</td> <td>3.5</td> <td>3.5</td> <td>3.5</td> </tr> <tr> <td>3 Door On</td> <td>-15.0</td> <td>-16.0</td> <td>-17.0</td> <td>-18.0</td> <td>-19.0</td> <td>-20.0</td> <td>-21.0</td> <td>-22.0</td> <td>-23.0</td> </tr> <tr> <td>Off</td> <td>-19.0</td> <td>-20.0</td> <td>-21.0</td> <td>-22.0</td> <td>-23.0</td> <td>-24.0</td> <td>-25.0</td> <td>-26.0</td> <td>-27.0</td> </tr> <tr> <td>ΔT</td> <td>4.0</td> <td>4.0</td> <td>4.0</td> <td>4.0</td> <td>4.0</td> <td>4.0</td> <td>4.0</td> <td>4.0</td> <td>4.0</td> </tr> <tr> <th>°F</th> <th>1</th> <th>2</th> <th>3</th> <th>4</th> <th>5</th> <th>6</th> <th>7</th> <th>8</th> <th>9</th> </tr> <tr> <td>1 Door On</td> <td>6.8</td> <td>5.0</td> <td>3.2</td> <td>1.4</td> <td>-0.4</td> <td>-2.2</td> <td>-4.0</td> <td>-5.8</td> <td>-7.6</td> </tr> <tr> <td>Off</td> <td>-0.4</td> <td>-2.2</td> <td>-4.0</td> <td>-5.8</td> <td>-7.6</td> <td>-9.4</td> <td>-11.2</td> <td>-13.0</td> <td>-14.8</td> </tr> <tr> <td>ΔT</td> <td>39.2</td> <td>39.2</td> <td>39.2</td> <td>39.2</td> <td>39.2</td> <td>39.2</td> <td>39.2</td> <td>39.2</td> <td>39.2</td> </tr> <tr> <td>2 Door On</td> <td>9.5</td> <td>7.7</td> <td>5.9</td> <td>4.1</td> <td>2.3</td> <td>0.5</td> <td>-1.3</td> <td>-3.1</td> <td>-4.9</td> </tr> <tr> <td>Off</td> <td>3.2</td> <td>1.4</td> <td>-0.4</td> <td>-2.2</td> <td>-4.0</td> <td>-5.8</td> <td>-7.6</td> <td>-9.4</td> <td>-11.2</td> </tr> <tr> <td>ΔT</td> <td>38.3</td> <td>38.3</td> <td>38.3</td> <td>38.3</td> <td>38.3</td> <td>38.3</td> <td>38.3</td> <td>38.3</td> <td>38.3</td> </tr> <tr> <td>3 Door On</td> <td>5.0</td> <td>3.2</td> <td>1.4</td> <td>-0.4</td> <td>-2.2</td> <td>-4.0</td> <td>-5.8</td> <td>-7.6</td> <td>-9.4</td> </tr> <tr> <td>Off</td> <td>-2.2</td> <td>-4.0</td> <td>-5.8</td> <td>-7.6</td> <td>-9.4</td> <td>-11.2</td> <td>-13.0</td> <td>-14.8</td> <td>-16.6</td> </tr> <tr> <td>ΔT</td> <td>39.2</td> <td>39.2</td> <td>39.2</td> <td>39.2</td> <td>39.2</td> <td>39.2</td> <td>39.2</td> <td>39.2</td> <td>39.2</td> </tr> </tbody> </table>	°C	1	2	3	4	5	6	7	8	9	1 Door On	-14.0	-15.0	-16.0	-17.0	-18.0	-19.0	-20.0	-21.0	-22.0	Off	-18.0	-19.0	-20.0	-21.0	-22.0	-23.0	-24.0	-25.0	-26.0	ΔT	4.0	4.0	4.0	4.0	4.0	4.0	4.0	4.0	4.0	2 Door On	-12.5	-13.5	-14.5	-15.5	-16.5	-17.5	-18.5	-19.5	-20.5	Off	-16.0	-17.0	-18.0	-19.0	-20.0	-21.0	-22.0	-23.0	-24.0	ΔT	3.5	3.5	3.5	3.5	3.5	3.5	3.5	3.5	3.5	3 Door On	-15.0	-16.0	-17.0	-18.0	-19.0	-20.0	-21.0	-22.0	-23.0	Off	-19.0	-20.0	-21.0	-22.0	-23.0	-24.0	-25.0	-26.0	-27.0	ΔT	4.0	4.0	4.0	4.0	4.0	4.0	4.0	4.0	4.0	°F	1	2	3	4	5	6	7	8	9	1 Door On	6.8	5.0	3.2	1.4	-0.4	-2.2	-4.0	-5.8	-7.6	Off	-0.4	-2.2	-4.0	-5.8	-7.6	-9.4	-11.2	-13.0	-14.8	ΔT	39.2	39.2	39.2	39.2	39.2	39.2	39.2	39.2	39.2	2 Door On	9.5	7.7	5.9	4.1	2.3	0.5	-1.3	-3.1	-4.9	Off	3.2	1.4	-0.4	-2.2	-4.0	-5.8	-7.6	-9.4	-11.2	ΔT	38.3	38.3	38.3	38.3	38.3	38.3	38.3	38.3	38.3	3 Door On	5.0	3.2	1.4	-0.4	-2.2	-4.0	-5.8	-7.6	-9.4	Off	-2.2	-4.0	-5.8	-7.6	-9.4	-11.2	-13.0	-14.8	-16.6	ΔT	39.2	39.2	39.2	39.2	39.2	39.2	39.2	39.2	39.2
°C	1	2	3	4	5	6	7	8	9																																																																																																																																																																																																		
1 Door On	-14.0	-15.0	-16.0	-17.0	-18.0	-19.0	-20.0	-21.0	-22.0																																																																																																																																																																																																		
Off	-18.0	-19.0	-20.0	-21.0	-22.0	-23.0	-24.0	-25.0	-26.0																																																																																																																																																																																																		
ΔT	4.0	4.0	4.0	4.0	4.0	4.0	4.0	4.0	4.0																																																																																																																																																																																																		
2 Door On	-12.5	-13.5	-14.5	-15.5	-16.5	-17.5	-18.5	-19.5	-20.5																																																																																																																																																																																																		
Off	-16.0	-17.0	-18.0	-19.0	-20.0	-21.0	-22.0	-23.0	-24.0																																																																																																																																																																																																		
ΔT	3.5	3.5	3.5	3.5	3.5	3.5	3.5	3.5	3.5																																																																																																																																																																																																		
3 Door On	-15.0	-16.0	-17.0	-18.0	-19.0	-20.0	-21.0	-22.0	-23.0																																																																																																																																																																																																		
Off	-19.0	-20.0	-21.0	-22.0	-23.0	-24.0	-25.0	-26.0	-27.0																																																																																																																																																																																																		
ΔT	4.0	4.0	4.0	4.0	4.0	4.0	4.0	4.0	4.0																																																																																																																																																																																																		
°F	1	2	3	4	5	6	7	8	9																																																																																																																																																																																																		
1 Door On	6.8	5.0	3.2	1.4	-0.4	-2.2	-4.0	-5.8	-7.6																																																																																																																																																																																																		
Off	-0.4	-2.2	-4.0	-5.8	-7.6	-9.4	-11.2	-13.0	-14.8																																																																																																																																																																																																		
ΔT	39.2	39.2	39.2	39.2	39.2	39.2	39.2	39.2	39.2																																																																																																																																																																																																		
2 Door On	9.5	7.7	5.9	4.1	2.3	0.5	-1.3	-3.1	-4.9																																																																																																																																																																																																		
Off	3.2	1.4	-0.4	-2.2	-4.0	-5.8	-7.6	-9.4	-11.2																																																																																																																																																																																																		
ΔT	38.3	38.3	38.3	38.3	38.3	38.3	38.3	38.3	38.3																																																																																																																																																																																																		
3 Door On	5.0	3.2	1.4	-0.4	-2.2	-4.0	-5.8	-7.6	-9.4																																																																																																																																																																																																		
Off	-2.2	-4.0	-5.8	-7.6	-9.4	-11.2	-13.0	-14.8	-16.6																																																																																																																																																																																																		
ΔT	39.2	39.2	39.2	39.2	39.2	39.2	39.2	39.2	39.2																																																																																																																																																																																																		
3	Turbo Freeze	Compressor F-fan C-fan LED	<ol style="list-style-type: none"> If Turbo Freeze button is pressed, Turbo freeze mode will start. If the Turbo Freeze button is pressed during Turbo Freeze mode, Turbo Freeze mode can be canceled. During Turbo Freeze mode, the temperature control button will not affect the temperature control. All bar LEDs are fully lighted during Turbo Freeze mode. The comp., F-fan and C-fan operate continuously for 120min. Turbo Freeze mode will start after defrost is completed, if you press the Turbo Freeze button during defrost function. In this case, display panel displays Turbo Freeze mode but Turbo Freeze mode actually starts after defrost function. Defrost function starts after Turbo Freeze mode if defrost function occurs during Turbo Freeze mode.  <p>*NOTE* F-sensor : Thermistor (Electrical resistance varies with temperature changing) Act like thermostat. Detect air temp. Wire color is orange. D-sensor : Thermistor Act like defrost terminator. Detect eva coil's temp. Wire color is blue.</p>																																																																																																																																																																																																								

ELECTRONIC CONTROLLER INSTRUCTION

No	Function	Controlled Part	Description																														
4	Defrost Function	Heater Compressor F-fan C-fan	<p>1. Defrost function is controlled by time interval setting. 2. Time interval can be set by shifting dip s/w on the PCB. 3. Time interval setting is as follows.</p> <table style="margin-left: auto; margin-right: auto; border-collapse: collapse;"> <thead> <tr> <th colspan="2" style="text-align: left;">Dip Switch</th> <th style="text-align: center;">Cycle time</th> </tr> <tr> <th style="text-align: center;">No.1</th> <th style="text-align: center;">No.2</th> <th style="text-align: center;">(hours)</th> </tr> </thead> <tbody> <tr> <td style="text-align: center;">0</td> <td style="text-align: center;">0</td> <td style="text-align: center;">12</td> </tr> <tr> <td style="text-align: center;">1</td> <td style="text-align: center;">0</td> <td style="text-align: center;">10</td> </tr> <tr> <td style="text-align: center;">0</td> <td style="text-align: center;">1</td> <td style="text-align: center;">8</td> </tr> <tr> <td style="text-align: center;">1</td> <td style="text-align: center;">1</td> <td style="text-align: center;">6</td> </tr> </tbody> </table> <p>4. Factory setting is 6 hours 5. The first defrost function will start at the half value of setting time.</p>	Dip Switch		Cycle time	No.1	No.2	(hours)	0	0	12	1	0	10	0	1	8	1	1	6												
Dip Switch		Cycle time																															
No.1	No.2	(hours)																															
0	0	12																															
1	0	10																															
0	1	8																															
1	1	6																															
5	Defrost Function	Heater Compressor F-fan C-fan	<p>1. Defrost step</p> <table style="margin-left: auto; margin-right: auto; border-collapse: collapse;"> <thead> <tr> <th></th> <th style="text-align: center;"><i>Pre-cool</i></th> <th style="text-align: center;"><i>Heater defrost</i></th> <th style="text-align: center;"><i>Pause</i></th> <th style="text-align: center;"><i>Fan Delay</i></th> </tr> </thead> <tbody> <tr> <td style="text-align: left;">Comp.</td> <td style="text-align: center;"><i>on</i></td> <td style="text-align: center;"><i>off</i></td> <td style="text-align: center;"><i>off</i></td> <td style="text-align: center;"><i>on</i></td> </tr> <tr> <td style="text-align: left;">F-fan</td> <td style="text-align: center;"><i>on</i></td> <td style="text-align: center;"><i>off</i></td> <td style="text-align: center;"><i>off</i></td> <td style="text-align: center;"><i>off</i></td> </tr> <tr> <td style="text-align: left;">C-fan</td> <td style="text-align: center;"><i>on</i></td> <td style="text-align: center;"><i>off</i></td> <td style="text-align: center;"><i>off</i></td> <td style="text-align: center;"><i>on</i></td> </tr> <tr> <td style="text-align: left;">Heater</td> <td style="text-align: center;"><i>off</i></td> <td style="text-align: center;"><i>on</i></td> <td style="text-align: center;"><i>off</i></td> <td style="text-align: center;"><i>off</i></td> </tr> <tr> <td style="text-align: left;">Max time</td> <td style="text-align: center;"><i>30 min.</i></td> <td style="text-align: center;"><i>40 min.</i></td> <td style="text-align: center;"><i>3 min.</i></td> <td style="text-align: center;"><i>5 min.</i></td> </tr> </tbody> </table> <p style="margin-left: 40px;"><i>If D-sensor temperature is over 50°F, heater goes off. If D-sensor is in error, heater goes off automatically 40 min after activated.</i></p> <p style="margin-left: 40px;"><i>If D-sensor temp. lower than 14°F, then F-fan turns on immediately</i></p> <p>A. Pre-Cool Step</p> <ol style="list-style-type: none"> a. It prevents exceeding temperature rise during defrost function. b. Comp., C-fan and F-fan run continuously during pre-cool step. c. 88 LED indicates inside temp. and bar LED indicates setting temperature level. d. Maximum pre-cool time is 30 min. e. If F-sensor detects 1.8°F lower temp. than lowest comp. off temp., in a 30 min., pre-cool step goes off. f. Turbo Freeze mode is only one time prior to pre-cool step. <p>B. Heater defrost step</p> <ol style="list-style-type: none"> a. The defrost heater is energized. b. 88 LED displays 'dF' and bar LED indicates setting temp. level. c. The defrost heater warms the evaporator coil thereby melting all frost accumulated during the previous refrigeration cycle. d. When D-sensor is higher than 50°F(10°C), heater goes off. e. If for any reason D-heater's on time excess 40 min., a back-up defrost termination is also provided. f. If D-sensor's temp. didn't reach 50°F(10°C) in 40 min., error code will be recorded on a MICOM. <div style="text-align: right; margin-right: 50px;">  </div> <p>C. Pause step</p> <ol style="list-style-type: none"> a. Time = 3 min. b. 88 LED displays 'dF' and bar LED indicates setting temp. level. <p>D. Fan delay step</p> <ol style="list-style-type: none"> a. Max. Time = 5 min b. Only Comp. and C-fan are on. c. If D-sensor temp. goes down under 14°F in 5 min., then F-fan turns on immediately. 		<i>Pre-cool</i>	<i>Heater defrost</i>	<i>Pause</i>	<i>Fan Delay</i>	Comp.	<i>on</i>	<i>off</i>	<i>off</i>	<i>on</i>	F-fan	<i>on</i>	<i>off</i>	<i>off</i>	<i>off</i>	C-fan	<i>on</i>	<i>off</i>	<i>off</i>	<i>on</i>	Heater	<i>off</i>	<i>on</i>	<i>off</i>	<i>off</i>	Max time	<i>30 min.</i>	<i>40 min.</i>	<i>3 min.</i>	<i>5 min.</i>
	<i>Pre-cool</i>	<i>Heater defrost</i>	<i>Pause</i>	<i>Fan Delay</i>																													
Comp.	<i>on</i>	<i>off</i>	<i>off</i>	<i>on</i>																													
F-fan	<i>on</i>	<i>off</i>	<i>off</i>	<i>off</i>																													
C-fan	<i>on</i>	<i>off</i>	<i>off</i>	<i>on</i>																													
Heater	<i>off</i>	<i>on</i>	<i>off</i>	<i>off</i>																													
Max time	<i>30 min.</i>	<i>40 min.</i>	<i>3 min.</i>	<i>5 min.</i>																													

ELECTRONIC CONTROLLER INSTRUCTION

No.	Function	Controlled Part	Description
6	Forced Defrost	Comp F-fan C-fan Heater	a. Press and hold up/down button, and press turbo freeze button 5 times. b. Forced defrost mode. 1) The pre-cool step is omitted. 2) Start from heater defrost step. 3) Next procedure is same as that of the defrost function.
7	Comp Restart Prevent	Comp C-fan	1. After comp. is off, comp. will not start for 3 min, even though the F-sensor is at on point.
8	Power Failure Back-Up Function	Comp F-fan C-fan	1. Compressor will not start for 3 min. after power failure. 2. F-fan is on.
9	Door opening Alarm function	Buzzer LED	1. If door is opened, fan goes off and lamp on. 2. If door is opened for more than 30 seconds, chirpy sound alarm buzzes 3 times. 3. If door is opened for more than 60 seconds, chirpy sound alarm buzzes 5 times. 4. If door is opened for more than 5 minutes, chirpy sound alarm buzzes continuously.
10	Buzzer Function	Buzzer	1. Alarm buzzes 1 time after initial power on. 2. Alarm buzzes whenever each button is pressed. 3. Alarm buzzes if door remains open for certain period. (See door opening alarm function)
11	Error Display	LED	1. If inside temp. is lower than -50°F or higher than 50, 88 LED indicates 'Lo' or 'Hi' respectively. 2. Press 'up' button 5 times with pressing and holding both 'down' button and 'Turbo Freeze' button. Above procedure switches normal display to error display mode. 3. If there was no error occurred before, there will be no change on the 88 LED. If there was any error occurred before, 88 LED will display error code. 4. Next error code will be displayed by pressing down button. 5. 10 seconds after the last button pressed, error display mode will be switched to normal display mode.

5-1-3. ERROR CODE TABLE

Code	Content	Perception Method	Refrigerator operation state
F1	F-sensor Malfunction	- short circuit - wire disconnection	- The comp. runs for 30 minutes and rest for 5 minutes. - Above action will repeat until fixed.
D1	D-sensor Malfunction	- short circuit - wire disconnection	- Heater turns on for at least 20 minutes, irrespective of D-sensor. - If F-sensor temp. is higher than 28.4°F then heater goes off. - Heater turns on for 20 min, if F-sensor is in error mode, too.
C1	Cycle, Comp Malfunction	- When the temp. of the D-sensor is over 32°F although the comp. has been running for 30 min.	- Normal operation
F3	Defrost Malfunction	When the D-sensor temp. doesn't reach 50°F in a 40 min.	- Reattempt normal defrost function repeatedly.

5-2. REFRIGERATOR CONTROLLER

5-2-1. HOW TO USE THE PANEL

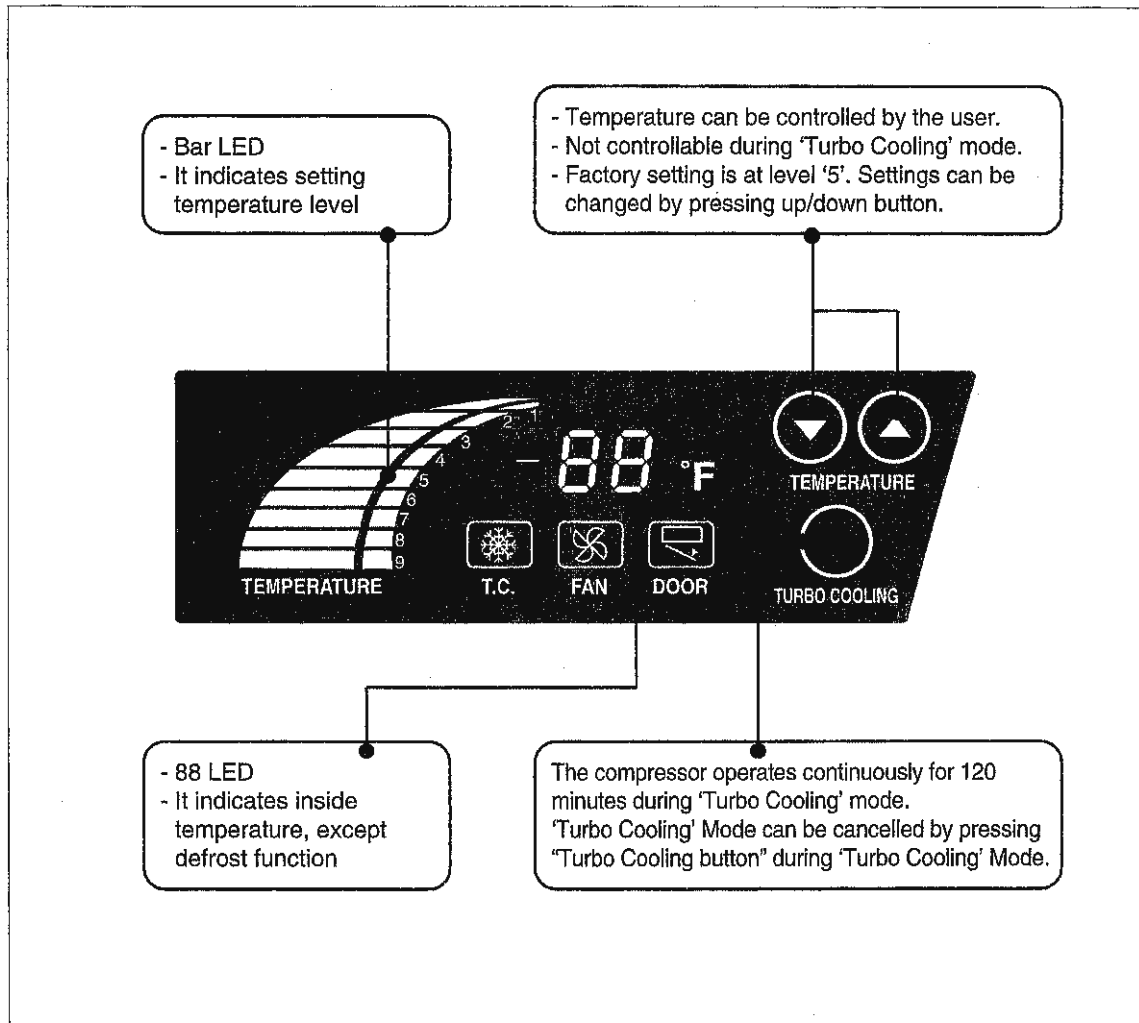

ELECTRONIC CONTROLLER INSTRUCTION

5-2-2. FUNCTION TABLE

No.	Function	Controlled Part	Description																																	
1	Initial Operation	Buzzer, Fan or Door Lamp Bar LED 88 LED	<ol style="list-style-type: none"> Buzzer will ring 2 sec. after Plug-In. 88 LED displays micom version initially and does inside temperature in 2 sec. Compressor runs, if evaporator temperature is higher than 41.0°F(5.0°C). Compressor will run 3 minutes after plug-in, if eva. temperature is lower than 41.0°F(5.0°C). 																																	
2	Temperature Control	Compressor F-fan C-fan LED	<ol style="list-style-type: none"> The temperature can be changed by pushing up/down buttons. 88 LED displays inside temperature. Buzzer buzzes 1 time whenever a button is pressed. Compressor automatically turns on and off by D-sensor (Except error mode) After Comp. is off, comp. will not start for 3 min. even though the D-sensor is at on point. F-fan runs continuously except when door is opened. F-fan will start 3 sec. after door is closed. Comp. on/off temperature(°F) <p>TSR-23SD, TSR-49SD, TSR-72SD</p> <table border="1"> <thead> <tr> <th>No.</th> <th>1</th> <th>2</th> <th>3</th> <th>4</th> </tr> </thead> <tbody> <tr> <td>Comp Off</td> <td>24.8</td> <td>23.9</td> <td>23.0</td> <td>22.1</td> </tr> <tr> <td>Comp On</td> <td>37.4</td> <td>37.4</td> <td>37.4</td> <td>37.4</td> </tr> </tbody> </table> <hr/> <table border="1"> <thead> <tr> <th>No.</th> <th>5</th> <th>6</th> <th>7</th> <th>8</th> <th>9</th> </tr> </thead> <tbody> <tr> <td>Comp Off</td> <td>21.2</td> <td>20.3</td> <td>19.4</td> <td>18.5</td> <td>17.6</td> </tr> <tr> <td>Comp On</td> <td>37.4</td> <td>37.4</td> <td>37.4</td> <td>37.4</td> <td>37.4</td> </tr> </tbody> </table>	No.	1	2	3	4	Comp Off	24.8	23.9	23.0	22.1	Comp On	37.4	37.4	37.4	37.4	No.	5	6	7	8	9	Comp Off	21.2	20.3	19.4	18.5	17.6	Comp On	37.4	37.4	37.4	37.4	37.4
No.	1	2	3	4																																
Comp Off	24.8	23.9	23.0	22.1																																
Comp On	37.4	37.4	37.4	37.4																																
No.	5	6	7	8	9																															
Comp Off	21.2	20.3	19.4	18.5	17.6																															
Comp On	37.4	37.4	37.4	37.4	37.4																															
3	Turbo Cooling	Compressor F-fan C-fan LED	<ol style="list-style-type: none"> If Turbo Cooling button is pressed, Turbo Cooling mode will start. If the Turbo Cooling button is pressed during Turbo Cooling mode, Turbo Cooling mode can be canceled. During Turbo Cooling mode, the temperature control button will not affect the temperature control. All bar LEDs are fully lighted during Turbo Cooling mode. The comp., E-fan and C-fan operate continuously for 120min. If D-sensor temperature comes to 14°F(-10°C), they stop regardless of 120min. Turbo Cooling mode will start after defrost is completed. If you press the Turbo Cooling button during defrost function. Defrost function starts after Turbo Cooling mode if defrost function occurs during Turbo Cooling mode.  <p>*NOTE* D-sensor : Thermistor (Electrical resistance varies with temperature changing) Act like thermostat. Detect eva. coil's temp. Wire color is blue. R-sensor : Thermistor Act like thermometer. Detect inside air temp. Wire color is white.</p>																																	

ELECTRONIC CONTROLLER INSTRUCTION

No	Function	Controlled Part	Description																		
4	Defrost Function	Compressor F-fan C-fan	<p>1. During defrost function, comp. goes off and F-fan goes ON. 2. Maximam defrost time is 70 minutes. 3. Defrost function is controlled by time interval setting. 4. Time interval can be set by shifting dip s/w on the PCB. 5. Time interval setting is as follows.</p> <table style="margin-left: auto; margin-right: auto;"> <thead> <tr> <th colspan="2"><i>Dip Switch</i></th> <th><i>Cycle time</i></th> </tr> <tr> <th><i>No.1</i></th> <th><i>No.2</i></th> <th><i>(hours)</i></th> </tr> </thead> <tbody> <tr> <td style="text-align: center;">0</td> <td style="text-align: center;">0</td> <td style="text-align: center;">60</td> </tr> <tr> <td style="text-align: center;">1</td> <td style="text-align: center;">0</td> <td style="text-align: center;">48</td> </tr> <tr> <td style="text-align: center;">0</td> <td style="text-align: center;">1</td> <td style="text-align: center;">36</td> </tr> <tr> <td style="text-align: center;">1</td> <td style="text-align: center;">1</td> <td style="text-align: center;">24</td> </tr> </tbody> </table> <p>6. Factory setting is 24 hours 7. The first defrost function will start at the half value of setting time.</p>	<i>Dip Switch</i>		<i>Cycle time</i>	<i>No.1</i>	<i>No.2</i>	<i>(hours)</i>	0	0	60	1	0	48	0	1	36	1	1	24
<i>Dip Switch</i>		<i>Cycle time</i>																			
<i>No.1</i>	<i>No.2</i>	<i>(hours)</i>																			
0	0	60																			
1	0	48																			
0	1	36																			
1	1	24																			
5	Defrost Function	Compressor F-fan C-fan	<p>1. If it becomes defrost cycle time, the refrigerator executes defrost function. 2. Defrost method is to operate only F-fan with comp. off. 3. Defrost function terminates when D-sensor temperature comes to above 50.0°F(10°C). 4. During defrost period, LED on the PCB does not display 'dF' but inside temperature, in difference to "Freezer Model". But, if inside temperature is above 39.2°F(4°C) during defrost period, LED displays 39.2°F(actually '39'), imaginarily. 5. After defrost completed, if inside temperature comes to go down below 39.2°F(4°C), LED displays real time temperature.</p>																		

ELECTRONIC CONTROLLER INSTRUCTION

No	Function	Controlled Part	Description
6	Forced Defrost	Comp F-fan C-fan	a. Press the Turbo Cooling button 5 times while pressing both up/down button and defrost mode starts, immediately. b. Next procedure is same as that of the defrost function.
7	Comp Restart Prevent	Comp C-fan	1. After comp. is off, comp. will not start for 3 min, even though the D-sensor is at on point.
8	Power Failure Back-Up Function	Comp F-fan C-fan	1. Compressor will not start for 3 min. after power failure. 2. F-fan is on.
9	Door opening Alarm function	Buzzer LED	1. If door is opened, fan goes off and lamp on. 2. If door is opened for more than 30 seconds, chirpy sound alarm buzzes 3 times. 3. If door is opened for more than 60 seconds, chirpy sound alarm buzzes 5 times. 4. If door is opened for more than 5 minutes, chirpy sound alarm buzzes continuously.
10	Buzzer Function	Buzzer	1. Alarm buzzes 1 time after initial power on. 2. Alarm buzzes whenever each button is pressed. 3. Alarm buzzes if door remains open for certain period. (See door opening alarm function)
11	Error Display	LED	1. If inside temp. is lower than 14°F or higher than 69, 88 LED indicates 'Lo' or 'Hi' respectively. 2. Press 'up' button 5 times with pressing and holding both 'down' button and 'Turbo Cooling' button. Above procedure switches normal display to error display mode. 3. If there was no error occurred before, there will be no change on the 88 LED. If there was any error occurred before, 88 LED will display error code. 4. Next error code will be displayed by pressing down button. 5. 10 seconds after the last button pressed, error display mode will be switched to normal display mode.

5-2-3. ERROR CODE TABLE

Code	Content	Perception Method	Refrigerator operation state
R1	R-sensor Malfunction	- short circuit - wire disconnection	- Normal operation
D1	D-sensor Malfunction	- short circuit - wire disconnection	- Comp. is controlled to be turned on/off with fixed time interval. (On: 30min., Off: 30min.) - If R-sensor temp. is higher than 50.0°F then defrost mode is over. - To make matters worse, if R-sensor is in error, too, defrost mode lasts for only 40min.
C1	Cycle, Comp Malfunction	- When the temp. of the D-sensor is over 32°F although the comp. has been running for 30 min.	- Normal operation

6. PART-LIST OF SOLID DOOR MODEL

Part name	Code	Material	Description	Model					
				R-23S	R-49S	F-23S	F-49S	R-72S	F-72S
Caster									
CASTER	30265L0200		TP5040-22-HDP	2	2	2	2	3	3
CASTER BRAKE	30265L0100		TP5040-22-HDP-TLB	2	2	2	2	3	3
Compressor									
COMPRESSOR RUN CAPACITOR	400EL15130		230V/10 μ F	1					
COMPRESSOR START CAPACITOR	401RD35050		200V/100 μ F	1					
COMPRESSOR	3952127G10		HBL27YE-1	1					
COMPRESSOR	3020014540		SK6A1C-H2Y		1				
COMPRESSOR	30200L0100		AEA2411ZXA			1			
COMPRESSOR	30200L0200		AJA2425ZXA				1		
COMPRESSOR	30200A4700		AKA4476YXA					1	
COMPRESSOR	30206Q3600		CAJ2446Z						1
COMPRESSOR POWER CORD (RELAY HARNESS)	30200L3400		INCLUDED PTC, OL	1					
COMPRESSOR POWER CORD (RELAY HARNESS)	30227Q1400								1
COMPRESSOR POWER CORD (RELAY HARNESS)	30227L0502						1	1	
COMPRESSOR POWER CORD (RELAY HARNESS)	30227L0602				1				
COMPRESSOR POWER CORD (RELAY HARNESS)	30227L2800					1			
POWER RELAY (COMP. RELAY)	8536490000		G7L-1A-TUB(OMRON)	1	1	1	1	1	1
ELECTRICAL BOX HARNESS	30227L1711			1					
ELECTRICAL BOX HARNESS	30227L0802				1	1	1	1	
ELECTRICAL BOX HARNESS	30227Q1100								1
MAIN POWER CORD	30213A1010		125V, 15A	1	1	1	1	1	
MAIN POWER CORD	30213Q0201		115V, 30A						1
Condenser									
CONDENSER COIL	30200L4001			1					
CONDENSER COIL	30200L4201				1				
CONDENSER COIL	30200L4101					1			
CONDENSER COIL	30200L4302						1	1	
CONDENSER COIL	30200Q3500								1
CONDENSER COIL SHROUD	30214L4500			1	1				
CONDENSER COIL SHROUD	30214L4600					1	1	1	
CONDENSER COIL SHROUD	30214Q2800								1
CAPILLARY TUBE	30244Q0300	C1220T	L=950 ID ϕ 1.2	1					
CAPILLARY TUBE	30244L1302	C1220T	L950 ID ϕ 1.2		1	1			
CAPILLARY TUBE	30244Q0400	C1220T	L3378 ID ϕ			1			
CAPILLARY TUBE	30244L1402	C1220T	L4425 ID ϕ 2.0				1		

PART-LIST OF SOLID DOOR MODEL

Part name	Code	Material	Description	Model					
				R-23S	R-49S	F-23S	F-49S	R-72S	F-72S
CAPILLARY TUBE (A)	30244Q1000	C1220T	L2263 IDø3.56					1	1
CAPILLARY TUBE (B)	30244Q1100	C1220T	L3505 IDø2.0						1
CONDENSER DRYER	30268L0300	C1220T	XH-9 50g ø3.1	1	1				
CONDENSER DRYER	30268L0400	C1220T	XH-9 50g ø3.5			1	1		
CONDENSER DRYER	30268Q0100	C1220T	XH-9 50g ø5.0					1	
CONDENSER DRYER	30268Q0210	C1220T	XH-9 50g ø5.0						1
Condenser Fan									
CONDENSER FAN MOTOR BLADE	30218B0100	AL	ø225	1	1				2
CONDENSER FAN MOTOR BLADE	30218A0100	AL	ø250			1	1	1	
CONDENSER FAN MOTOR	3963220410		IS-4420DWSG-1	1	1	1	1	1	
CONDENSER FAN MOTOR	3963322020		IS-4420DWSQ-1						2
Door									
DOOR BUSHING	3007H1000		PA-6	2	4	2	4	3	3
DOOR ASSEMBLY	30200L3100			1					
DOOR ASSEMBLY	30200L2900					1			
DOOR ASSEMBLY(LEFT)	30200L2600				1			1	
DOOR ASSEMBLY(LEFT)	30200L2400						1		1
DOOR ASSEMBLY(MIDDLE)	30200Q2320							1	
DOOR ASSEMBLY(RIGHT)	30200L2700				1			1	
DOOR ASSEMBLY(RIGHT)	30200L2500						1		1
DOOR ASSEMBLY(MIDDLE)	30200Q2330								1
DOOR GASKET	30223L0211	PVC-S		1	2	1	2	3	3
DOOR HINGE SPRING	30251L0100		ø3.4	1	2	1	2	3	3
CABINET FRAME HEATER	30228L0111	45W		1		1			
CABINET FRAME HEATER	30228L0203	60W			1		1		
CABINET FRAME HEATER	30228Q0100	75W	L=6700mm					1	1
MULLION COVER	30214Q2500	STS430			1		1	2	2
MULLION HEATER	30228L0903	20W	L=2520mm		1		1		
MULLION HEATER	30228Q0300	25W	L=2520mm					1	1
DOOR HINGE TOP ASSEMBLY LEFT	30229L0800	SPCC, T3.0	MFZN (WH)		1		1	1	1
DOOR HINGE TOP ASSEMBLY RIGHT	30229L0900	SPCC, T3.0	MFZN (WH)	1	1	1	1	2	2
DOOR HINGE BOTTOM ASSEMBLY LEFT	30229L0100	SPCC, T5.0	MFZN (WH)		1		1	1	1
DOOR HINGE BOTTOM ASSEMBLY RIGHT	30229L0200	SPCC, T5.0	MFZN (WH)	1	1	1	1	2	2
Drain									
DRAIN PAN	30211L0700	HIPS		1		1			

PART-LIST OF SOLID DOOR MODEL

Part name	Code	Material	Description	Model					
				R-23S	R-49S	F-23S	F-49S	R-72S	F-72S
DRAIN PAN	30211J0103	HIPS			1		1	1	1
DRAIN WICKING BAR	30230J0700	PVC-H			1		1	1	1
DRAIN WICKING BAR	30230L0100	PVC-H		1		1			
DRAIN WICKING PADS	30245L1000	PULP	T2.5	5		5			
DRAIN WICKING PADS	30245A0700	PULP	T2.5		5		5	5	5
Evaporator									
DRAIN CAP	30209L0200	PA-6		1	1	1	1	1	1
EVAPORATOR DRAIN PAN	30211L0501	A1100P-H14	0.8T, WH PAINTING	1		1			
EVAPORATOR DRAIN PAN	30211L0601	A1100P-H14	0.8T, WH PAINTING		1		1		
EVAPORATOR DRAIN PAN	30211Q0100	A1100P-H14	0.8T, WH PAINTING					1	1
EVAPORATOR COIL	30270L0500					1			
EVAPORATOR COIL	30270L0600						1		
EVAPORATOR COIL	30270L0101			1					
EVAPORATOR COIL	30270Q0200							1	
EVAPORATOR COIL	30270L0202				1				
EVAPORATOR COIL	30270Q0100								1
THERMO PIPE	30244L2410			1	1			1	
EVAPORATOR SENSOR	30227Q1200		F-Sensor, D-Sensor			1	1		1
EVAPORATOR SENSOR	30227Q1300		R-Sensor, D-Sensor	1	1			1	
DRAIN PAN FIXTURE	30220L0502	A5052P-H14		1	1	1	1	1	1
EVAPORATOR THERMAL FUSE	30272L0400	250V/7.5A	PST-3(80/10)			1	1		1
EVAPORATOR DRAIN ELBOW	30225L0100	PA-6		1	1	1	1	1	1
EVAPORATOR DEFROST HEATER	30228L0802	SUS304, ø8	445W			1			
EVAPORATOR DEFROST HEATER	30228L0700	SUS304, ø8	600W				1		
EVAPORATOR DEFROST HEATER	30228Q0600	SUS304, ø8	900W						1
EVAPORATOR DRAIN PAN HEATER	30228L1400	90W	L=6,225mm			1			
EVAPORATOR DRAIN PAN HEATER	30228Q0500	90W	L=8,290m						1
EVAPORATOR DRAIN PAN HEATER	30228L1500	90W	L=9,335mm				1		
DRAIN HOSE HEATER	30228L1310	10W	L=700mm			1	1		1
DRAIN PAN INSULATOR	30233L0100	E-PS		1		1			
DRAIN PAN INSULATOR	30233L0200	E-PS			1		1		
DRAIN PAN INSULATOR	30233Q0100	E-PS						1	1
EVAPORATOR FAN MOTOR GUARD	30214K0100	ABS		1	2	1	2	2	2
EVAPORATOR FAN MOTOR BLADE	30218F0200	AL	ø175	1	2	1	2	2	2
EVAPORATOR FAN MOTOR	3963328120		IS-4420DWSN-2A	1	2	1	2	2	2

PART-LIST OF SOLID DOOR MODEL

Part name	Code	Material	Description	Model						
				R-23S	R-49S	F-23S	F-49S	R-72S	F-72S	
DUCT (A)	30269L0304	SUS 304		1		1				
DUCT (A)	30269L0404	SUS 304			1		1			
DUCT (A)	30269Q0500	SUS 304						1	1	
DUCT (B)	30269L0507	SUS 304		1		1				
DUCT (B)	30269L0606	SUS 304			1		1			
DUCT (B)	30269Q0400	SUS 304						1	1	
Top Grille Panel										
TOP GRILLE PANEL ASSEMBLY	30224L0450			1						
TOP GRILLE PANEL ASSEMBLY	30224L0230				1					
TOP GRILLE PANEL ASSEMBLY	30224L0350					1				
TOP GRILLE PANEL ASSEMBLY	30224L0130						1			
TOP GRILLE PANEL ASSEMBLY	30200Q3800							1		
TOP GRILLE PANEL ASSEMBLY	30200Q4000								1	
TOP GRILLE PANEL	30224L0304	STS304-HL		1		1				
TOP GRILLE PANEL	30224L0104	STS304-HL			1		1			
TOP GRILLE PANEL	30200Q3900	STS304-HL						1	1	
TOP GRILLE	30216Q0100	ABS	BLACK	1		1				
TOP GRILLE	30216Q0200	ABS	BLACK		1		1			
TOP GRILLE	30216Q0300	ABS	BLACK					1	1	
BRAND LOGO	30242Q0500		BLACK, HOT-STAMP	1	1	1	1	1	1	1
PCB HARNESS	30227L1001			1	1	1	1	1	1	1
FRONT LABEL	30235Q0900	PC, T0.254		1	1			1		
FRONT LABEL	30235L0100	PC, T0.254				1	1			1
DOOR LOCK(KEY)	30238G0100			1	2	1	2	3	3	
CONTROL BOARD HOUSING	30242L0100		BLACK, HOT-STAMP	1	1	1	1	1	1	1
DISPLAY PCB	30243Q0100			1	1			1		
DISPLAY PCB	30243L0100			1						
MAIN PCB	30243L0300						1			
MAIN PCB	30243L0310			1	1			1		
MAIN PCB	30243L0200					1				
MAIN PCB	30243Q0300									1
POWER SWITCH (ROCKER SWITCH)	30281Q0100		125V/15A	1	1	1	1	1	1	1
DOOR SWITCH	30281L0100		SP201R-10D	1	2	1	2	3	3	
TRANSFORMER	30284L0100		DWS-115U	1	1	1	1	1	1	1
Bottom Grille										
BOTTOM GRILLE ASSEMBLY	30224L1410	STS304-HL		1		1				

7. REPLACEMENT OF MAIN COMPONENTS

7-1. TOP GRILLE PARTS

- MAIN PCB or TRANSFORMER
- DISPLAY PCB
- DOOR LOCK or POWER SWITCH (ROCKER SWITCH)
- DOOR SWITCH

A. Unscrew the screw located both sides of top grille panel.



REPLACEMENT OF MAIN COMPONENTS

B. Unscrew the screws located on top of top grille panel.



REPLACEMENT OF MAIN COMPONENTS

C. Unscrew the screws located on bottom of top grille panel.

* Caution : When unscrewing, hold the top grille panel.
Falling down top grille may cause bruise.



D. Place the top grille panel on the top of the cabinet.



E. You can replace PCB, Transformer.



REPLACEMENT OF MAIN COMPONENTS

F. Pull out the harness located back of top grille panel.

You can separate top grille panel.

You can replace power switch(rocker switch), door switches(lamp switch) and control board housing.



G. To re-assemble, do reversed in order.

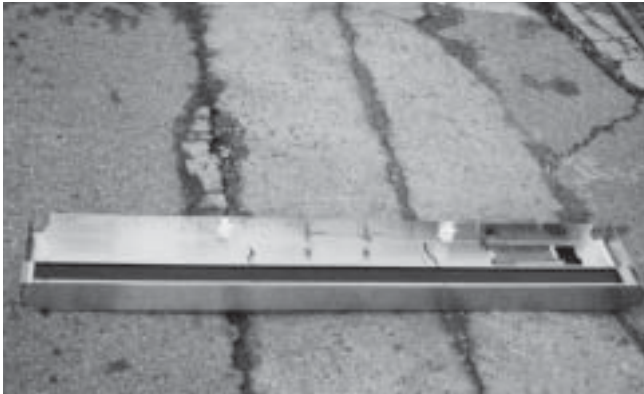

REPLACEMENT OF MAIN COMPONENTS

7-2. REPLACING DOOR

A. Disassemble top grille panel as described section 7-1 A.B.C.D.

B. Remove Bottom Grille by unscrewing the four screws located on each side of the Bottom Grille.



C. Open the electrical box. Then uncap the door heater wire. (Freezer model only)

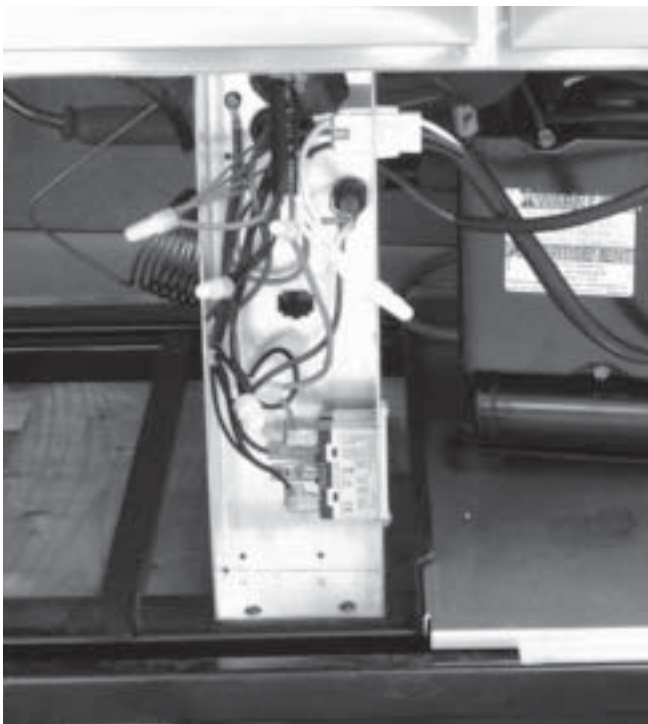

REPLACEMENT OF MAIN COMPONENTS

D. The figure of the disassembled top grille panel.

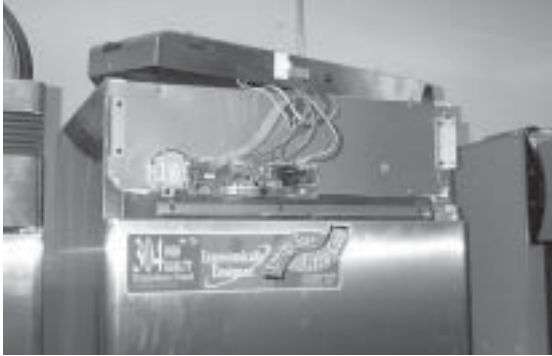

E. Unscrew the hinge.

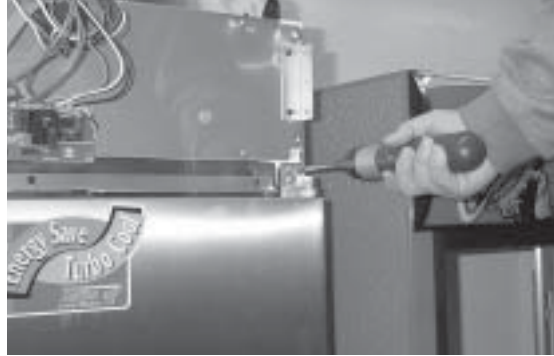

F. Unscrew the last screw with pushing the hinge.



G. After unscrewing, the hinge will rotate about 90° (CCW), of itself.



REPLACEMENT OF MAIN COMPONENTS

H. Lift the door and pull out the door heater's lead wire.



I. Replace the door with the new one.



J. Ready the hinge as below. It is important to set initial position (angle).



REPLACEMENT OF MAIN COMPONENTS

K. Initial position of the hinge must be as below.

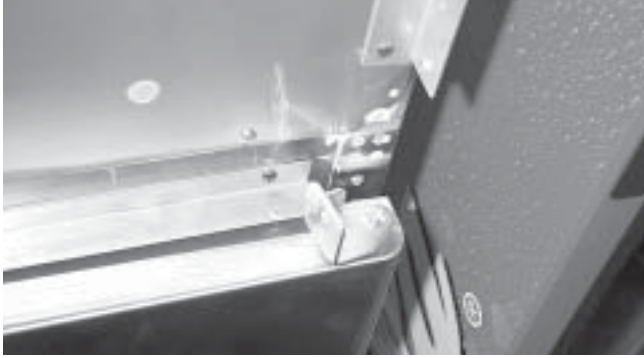

L. Turn the hinge 90° CW. This turning causes torsion strength of the bar spring that shuts the door(s) automatically.



M. Screw the hinge with pushing it. After installation of the door(s), assemble the top grille panel.



REPLACEMENT OF MAIN COMPONENTS

7-3. REFRIGERATION COMPARTMENT'S PARTS

A. Disassemble lamp shield.

- LAMP BULB or LAMP SHIELD
- EVAPORATOR FAN MOTOR
- F/D SENSOR or R/D SENSOR
- EVAPORATOR DEFROST HEATER
- EVAPORATOR COIL



B. Disassemble Duct (A).



C. Pull out the lamp harness.



REPLACEMENT OF MAIN COMPONENTS

D. Disassemble duct (B).



E. Pull-out the evaporator drain pan heater's leadwire.

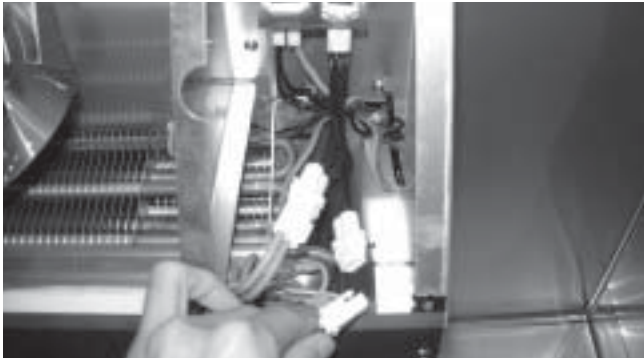

F. Figure of disassembled refrigeration compartments.

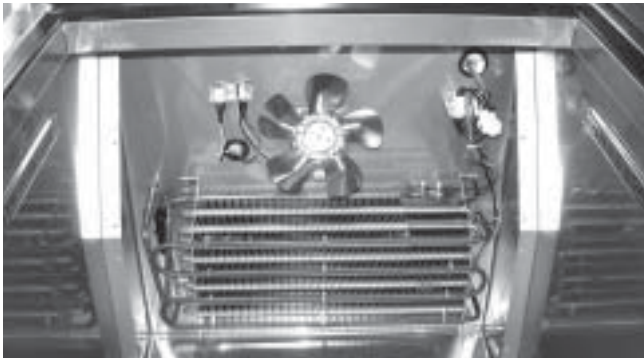

In this situation, you can replace fan motor, F/D-sensor, Evaporator coil, ETC.

REPLACEMENT OF MAIN COMPONENTS

G. Replacing evaporator fan motor

F-1. Pull out the fan motor's connector.

F-2. Unscrew the four screws which located on bottom of fan motor.



H. Replacing F/D-Sensor or R/D-Sensor

H-1. F-Sensor of Freezer

Unscrew as illustrated below and pull-out the F-Sensor from the cover.

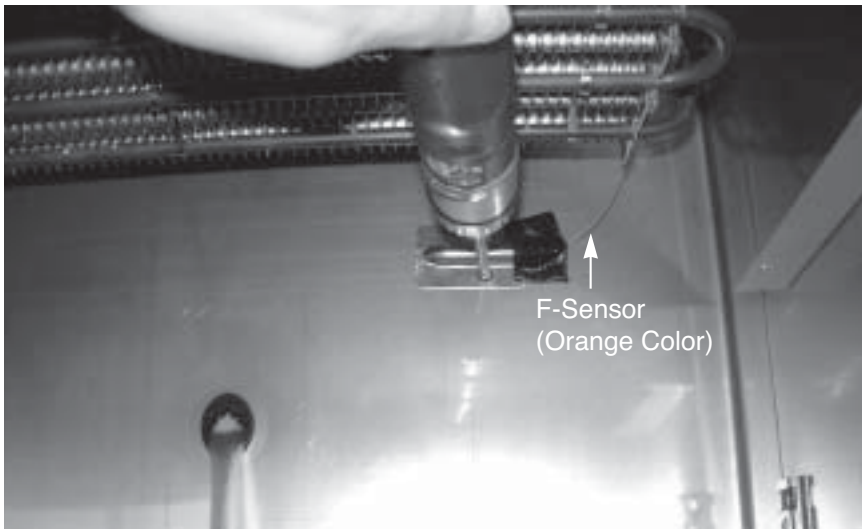

REPLACEMENT OF MAIN COMPONENTS

- H-2. D-Sensor of Freezer (Evaporator Defrost Sensor)
Disassemble the D-Sensor from evaporator's end plate.

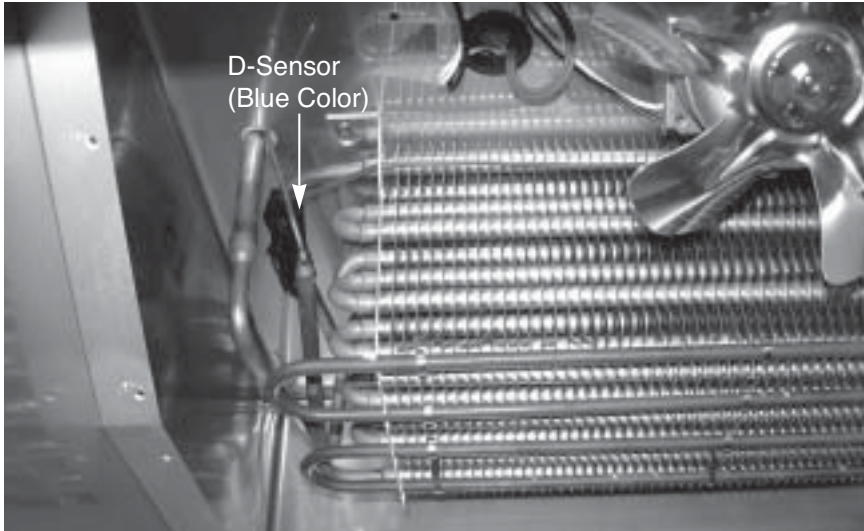

- H-3. R-Sensor of Refrigerator
Unscrew as illustrated below and pull-out the R-Sensor from the cover.

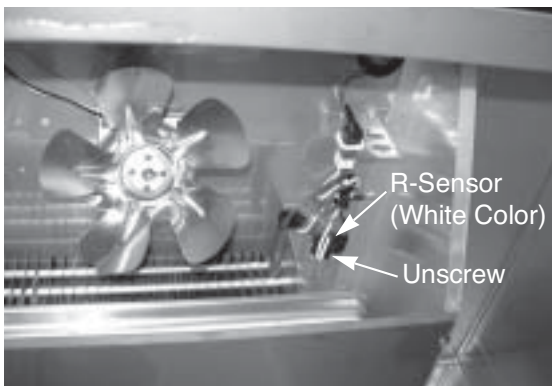

TSR-49SD
TSR-72SD

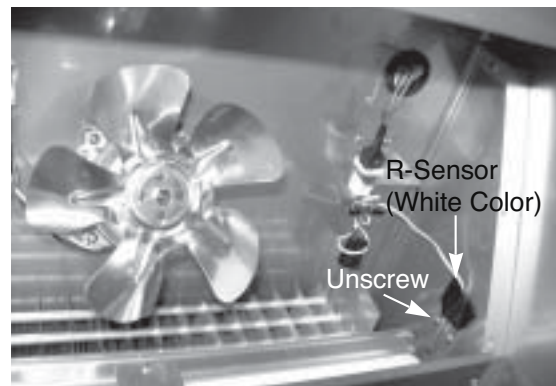

TSR-23SD

REPLACEMENT OF MAIN COMPONENTS

H-4. D-Sensor of Refrigerator

Remove the absorber pad at the end of thermo-pipe and pull-out the D-Sensor.

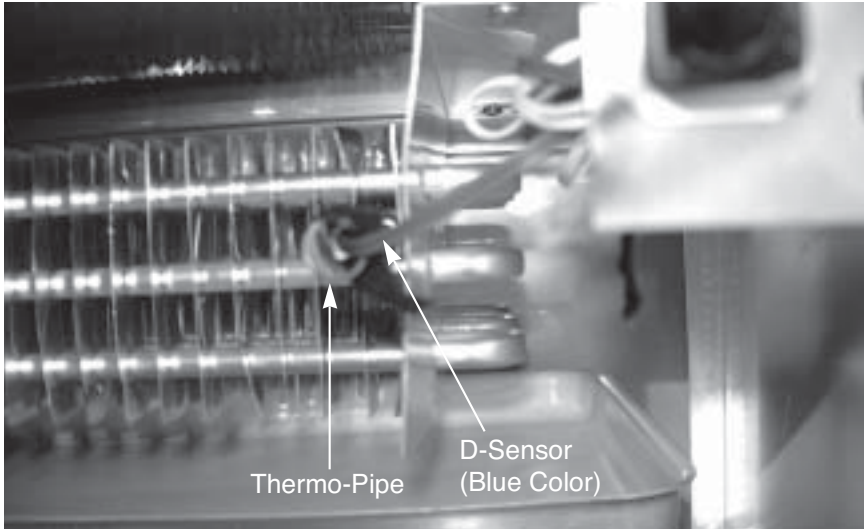

H-5. F/D Sensor or R/D Sensor

After unplug each sensor, pull-out the sensor's lead wire.

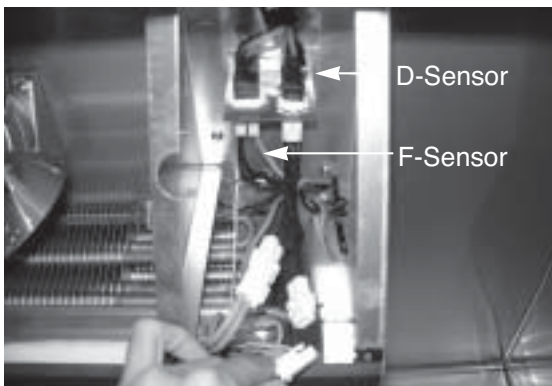

F/D Sensor
(F-Sensor : Orange Color,
D-Sensor : Blue Color)

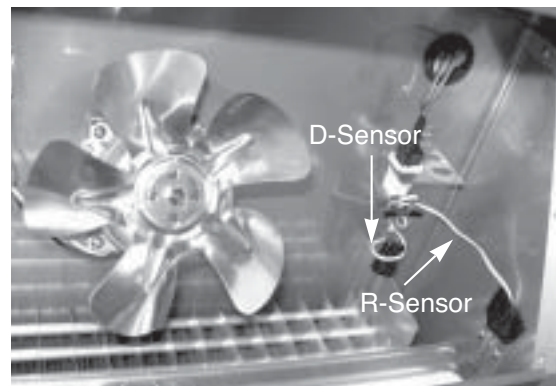

R/D Sensor
(R-Sensor : White Color,
D-Sensor : Blue Color)

REPLACEMENT OF MAIN COMPONENTS

REPLACING EVAPORATOR DEFROST HEATER (FREEZER ONLY)

A. After disassembling the duct(A) and the duct(B), get ready as below for replacing the evaporator defrost heater.

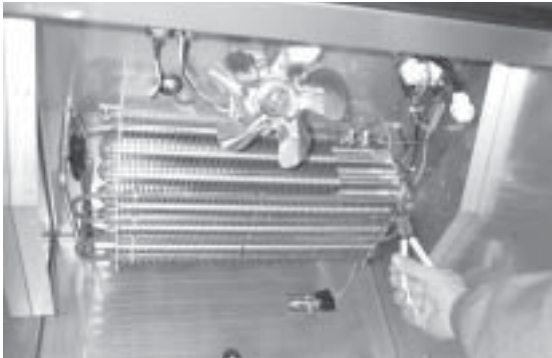

B. Pull out the pins from the bottom of the evaporator using the nipper, etc.

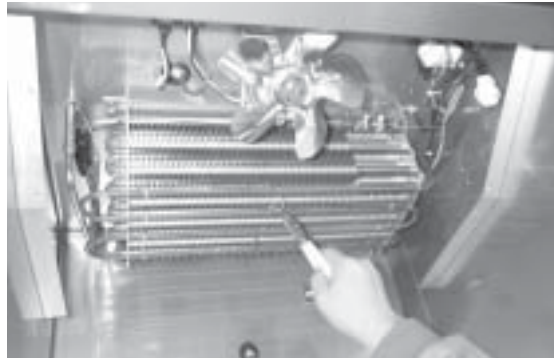

H. Split the hooks of the evaporator.



REPLACEMENT OF MAIN COMPONENTS

D. After removing all pins, disconnect the connectors from the thermal fuse and the main



E. Take apart the evaporator defrost heater from the evaporator.



REPLACEMENT OF MAIN COMPONENTS

F. Install the new evaporator defrost heater in original position.

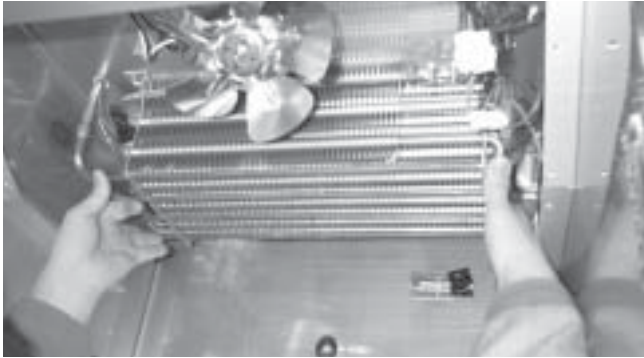

G. Pat the evaporator defrost heater with the soft hammer.

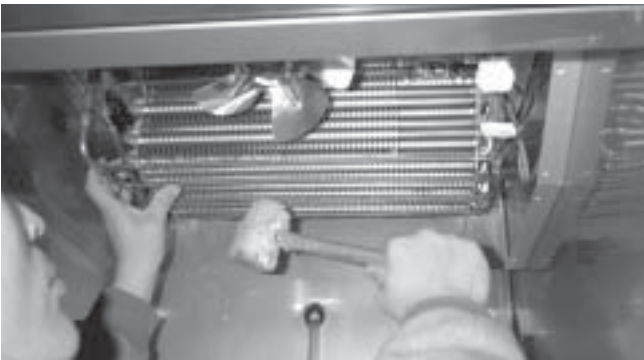

H. Pinch the hooks of the evaporator.



REPLACEMENT OF MAIN COMPONENTS

I . Assemble the pins in original positions.

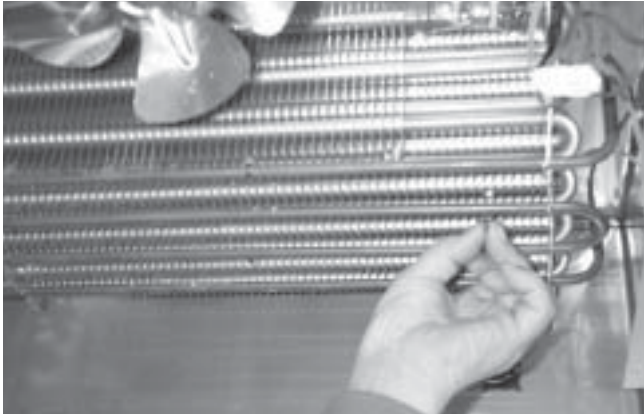

J. Connect the connectors of the evaporator defrost heater to them of the thermal fuse



*** NOTE**

Why is always 115 voltage detected between connectors of the evaporator defrost heater in the main harness?

The SNUBBER (located Main PCB) holds two AC power lines simultaneously.

The SNUBBER prevents Main PCB malfunction from sparks occurred by other electrical component's ON/OFF. (SNUBBER = Spark killer)

Because of the SNUBBER, 115 voltage is always detected, but electrical current in this case is very little (small Amps.). So, this electrical current is not enough to operate the evaporator defrost heater.

How to measure the Amps. of the evaporator defrost heater.

Disconnect the connectors of the evaporator defrost heater.

Then, prepare the additional Power Source (115V/60Hz) and the Amp. Meter.

Connect the evaporator defrost heater to the additional power source and read amp. value from the Amp. Meter.

REPLACEMENT OF MAIN COMPONENTS

7-4. CONDENSING UNIT

- Condensing units : Compressor, Condenser Fan Motor, Condenser Coil, Condenser Dryer....
- Others : Compressor Power Cord (Relay harness), Main Power Cord, Electrical Box, ETC.

A. Disassemble Bottom Grille as described section 7-2. B.

B. Unscrew two screws as below.

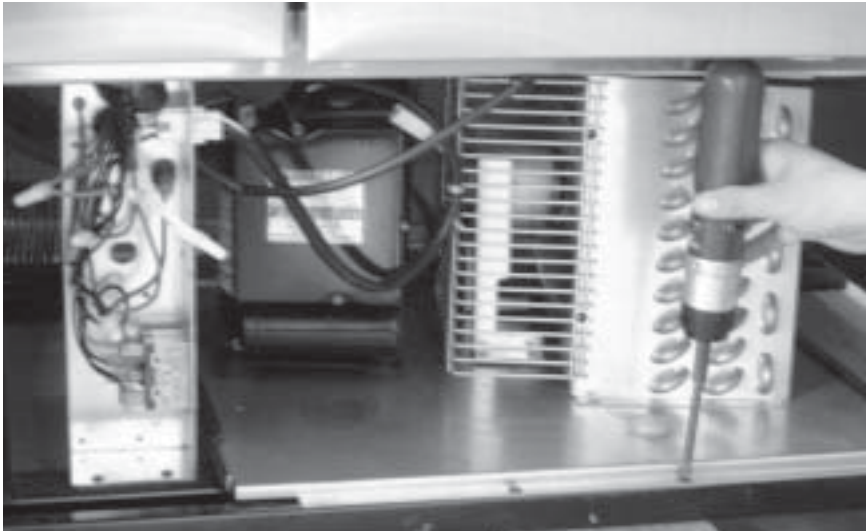

C. Unplug the compressor's power plug.

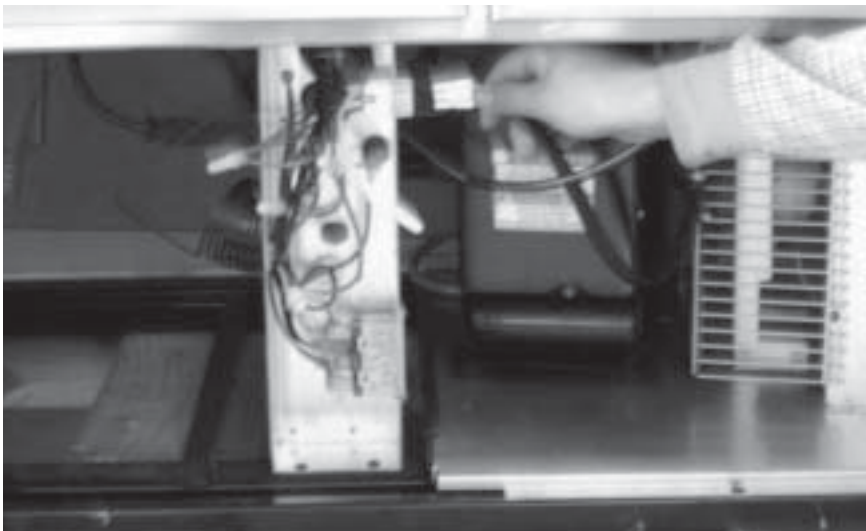

REPLACEMENT OF MAIN COMPONENTS

D. Pull-out the condensing unit.



REPLACEMENT OF MAIN COMPONENTS

7-5. REPLACING CABINET FRAME HEATER (and/or) MULLION HEATER

A. Insert the and edge of ‘-’type screw driver into the gap between the frame and the frame cover.



B. Take apart the frame cover from the frame.



C. Separate the frame cover by sliding the screw driver.



D. Do just like above instructions in other parts (bottom side, right side and top side).



REPLACEMENT OF MAIN COMPONENTS

E. Below picture shows the inlet of the cabinet frame heater toward the electrical box.

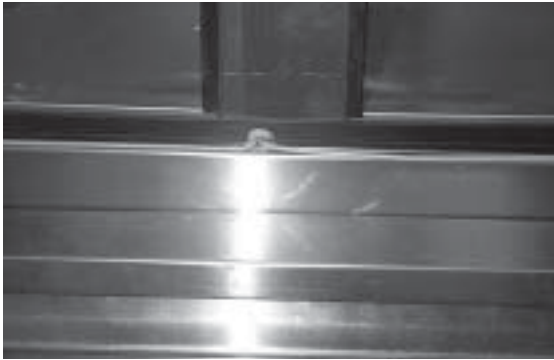

F. Uncap connectors of the cabinet frame heater.



G. Pull out the heater wire from the inlet.



H. Insert the new cabinet frame heater wire to the inlet, after surrounding it along the frame.



REPLACEMENT OF MAIN COMPONENTS

I. Assemble the frame cover with the frame. Push and slide the frame cover toward corner.

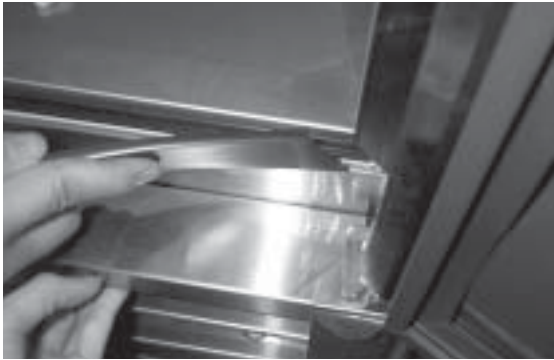

J. Fit the end lines of the frame cover each other.

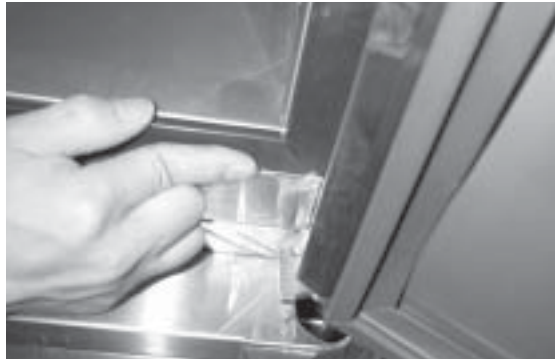

K. Fit the other side of the frame cover, too.



L. Pat the frame cover with the soft hammer, etc.



REPLACEMENT OF MAIN COMPONENTS

M. Do like above instructions in other parts (Left side, right side and top side).



REPLACEMENT OF MAIN COMPONENTS

N. Unscrew the screws from the mullion.

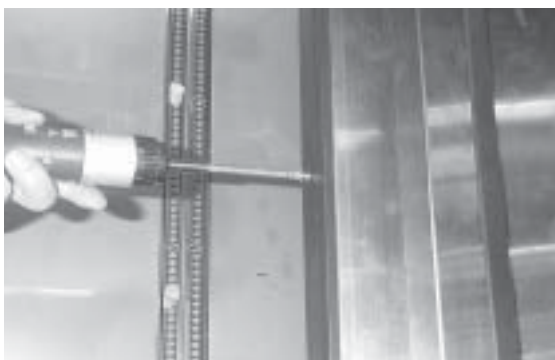

O. Take apart the mullion cover from the mullion.



P. Take care for the mullion heater not to be hurt. (It does not matter, if this heater is out of order).



REPLACEMENT OF MAIN COMPONENTS

Q. Pull out the insulator from inside.



R. Uncap connectors of the mullion heater.



S. Pull out the heater wire from the inlet.



REPLACEMENT OF MAIN COMPONENTS

T. Pull out the mullion cover(SUS) from the mullion cover (ABS).



U. Change the old mullion heater and install the new one with the gap between wires 1.2 inch.



V. Insert the mullion cover(SUS) into the original position.



REPLACEMENT OF MAIN COMPONENTS

W. Connect the heater wires with the main harness and the electrical box harness.



X. Cover the caps on the connection parts and press them tightly.

