

# Winston

## Hot Foods Merchandiser

### Parts Identification Manual



2345 Carton Drive  
Louisville, KY 40299 USA  
(800) 234-5286  
(502) 495-5400

# WINSTON HOT FOODS MERCHANDISER

## Table of Contents

Photo Reference ..... 1 - 4

Parts Descriptions & Order Numbers ..... 5 - 6

Wiring Diagram ..... 7

### How To Use This Manual

Use Photo Reference (pages 1 - 4) to identify parts. Match Photo Reference numbers with Parts Descriptions and Order Numbers (pages 5 - 6). To use Wiring Diagrams (Appendixes A - D), match model to corresponding Appendix (page 7).

# WINSTON HOT FOODS MERCHANDISER

## Parts Identification

**NOTE:** See page 5 - 6  
for Parts Descriptions  
and Order Numbers

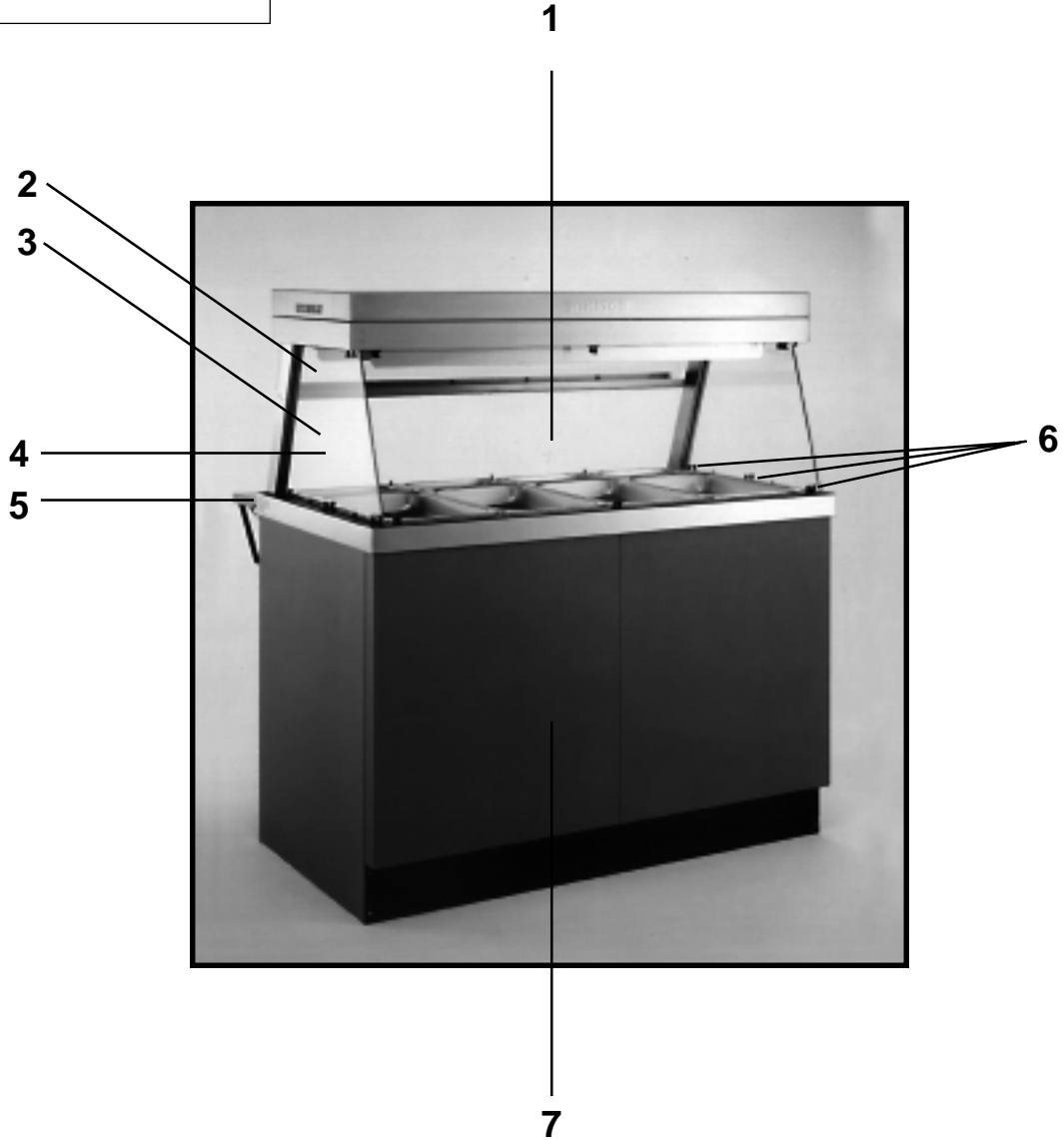

To order parts, contact your Winston representative or call the International office:

**Winston Products Co.**

**(800) 234-5286 USA & Canada/USA TEL: (502) 495-5400/USA FAX: (502) 495-5458**

# WINSTON HOT FOODS MERCHANDISER

## Parts Identification

**NOTE:** See page 5 - 6  
for Parts Descriptions  
and Order Numbers

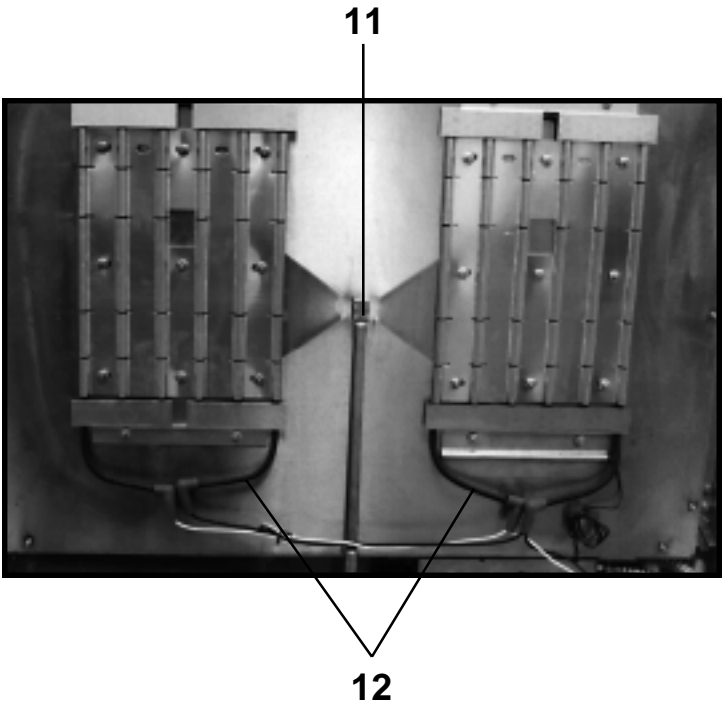
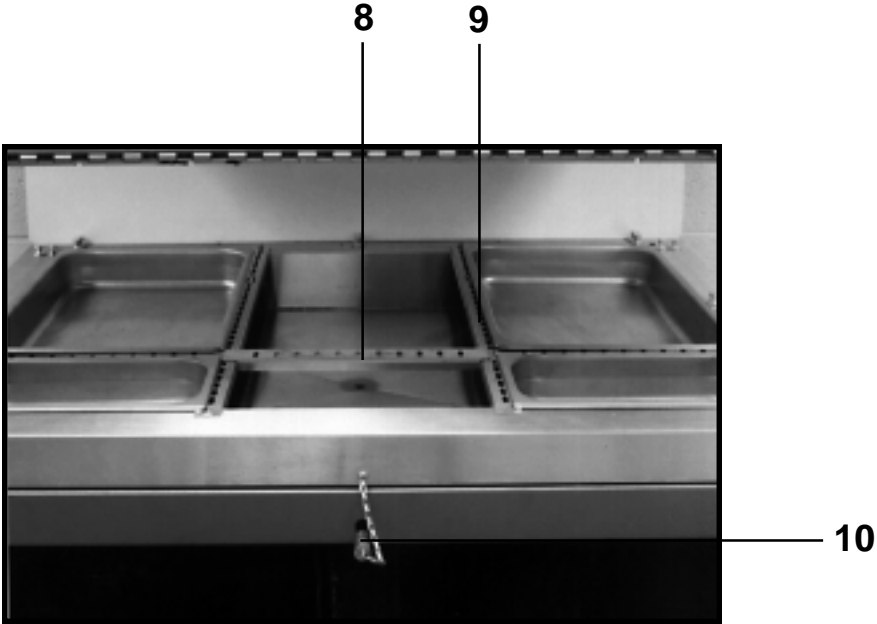

To order parts, contact your Winston representative or call the International office:  
**Winston Products Co.**  
**(800) 234-5286 USA & Canada/USA TEL: (502) 495-5400/USA FAX: (502) 495-5458**

# WINSTON HOT FOODS MERCHANDISER

## Parts Identification

**NOTE:** See page 5 - 6  
for Parts Descriptions  
and Order Numbers

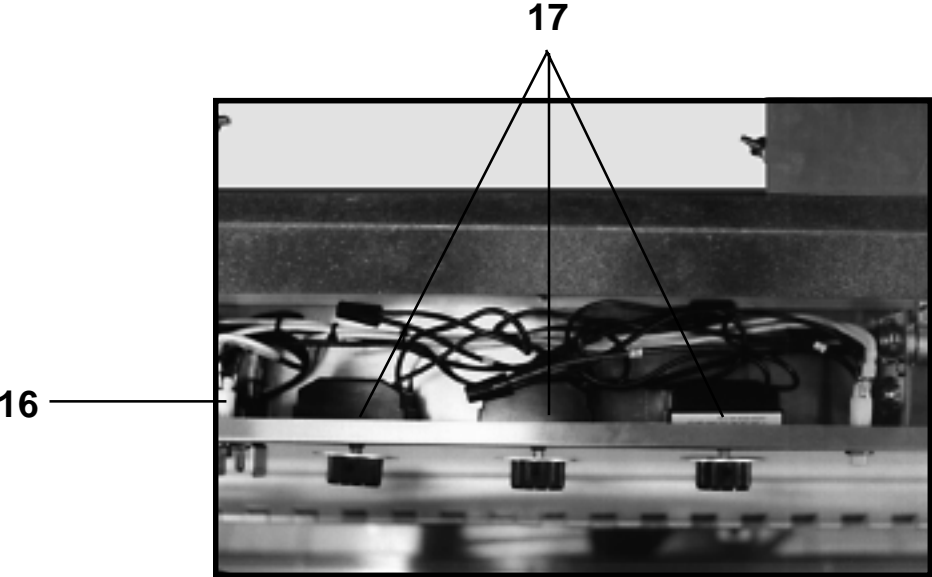
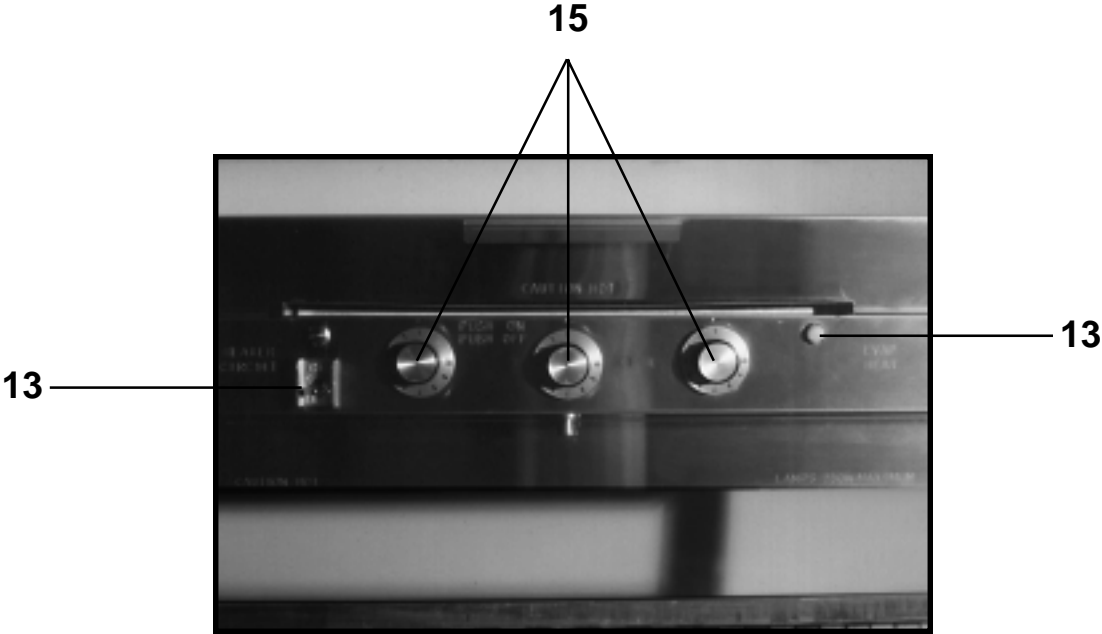

To order parts, contact your Winston representative or call the International office:  
**Winston Products Co.**  
**(800) 234-5286 USA & Canada/USA TEL: (502) 495-5400/USA FAX: (502) 495-5458**

# WINSTON HOT FOODS MERCHANDISER

## Parts Identification

**NOTE:** See page 5 - 6  
for Parts Descriptions  
and Order Numbers

18

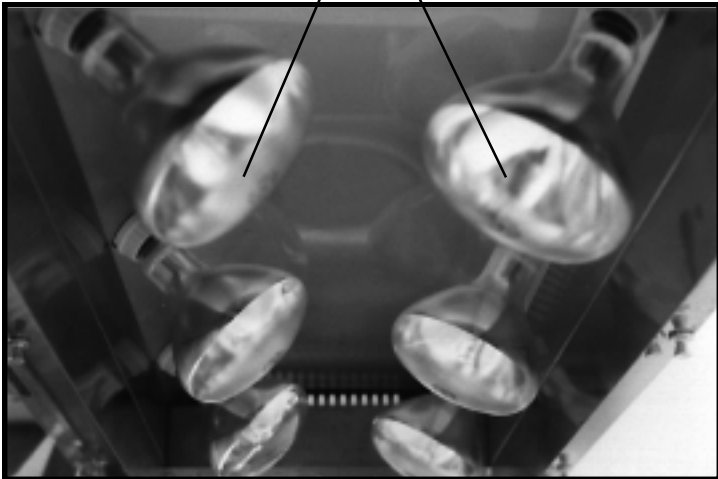

19

To order parts, contact your Winston representative or call the International office:  
**Winston Products Co.**  
**(800) 234-5286 USA & Canada/USA TEL: (502) 495-5400/USA FAX: (502) 495-5458**

# WINSTON HOT FOODS MERCHANDISER

## Parts Identification

| Photo Reference Number | Part Description  | Order Number   |
|------------------------|---|--|
| 1                      | <b>Front Glass (2 Pan)</b><br><b>Front Glass (3 Pan)</b><br><b>Front Glass (4 Pan)</b><br><b>Front Glass (5 Pan)</b>  | <b>HPS1612</b><br><b>HPS1611</b><br><b>HPS1610</b><br><b>HPS1840</b>                                     |
| 2                      | <b>Back Glass (2 Pan)</b><br><b>Back Glass (3 Pan)</b><br><b>Back Glass (4 Pan)</b><br><b>Back Glass (5 Pan)</b>  | <b>HPS1613</b><br><b>HPS1614</b><br><b>HPS1615</b><br><b>HPS1839</b>                                     |
| 3                      | <b>Door Assembly (2 Pan)</b><br><b>Door Assembly (3 Pan)</b><br><b>Door Assembly (4 Pan-Left Side)</b><br><b>Door Assembly (4 Pan-Right Side)</b><br><b>Door Assembly (5 Pan-Left Side)</b><br><b>Door Assembly (5 Pan-Right Side)</b><br><i>Note: 4 &amp; 5 Pan models equipped w/ split doors</i> | <b>HPS1597</b><br><b>HPS1596</b><br><b>HPS2234</b><br><b>HPS2235</b><br><b>HPS2236</b><br><b>HPS2237</b> |
| 4                      | <b>Side Glass (All Models)</b>  | <b>HPS1609</b>   |
| 5                      | <b>SS Serving Shelf (2 Pan)</b><br><b>SS Serving Shelf (3 Pan)</b><br><b>SS Serving Shelf (4 Pan)</b><br><b>SS Serving Shelf (5 Pan)</b>  | <b>HPS1381</b><br><b>HPS1382</b><br><b>HPS1383</b><br><b>HPS1794</b>                                     |
| 6                      | <b>Glass Tabs</b>   | <b>HPS1535/6</b>   |
| 7                      | <b>Floor Base Ass. (Mandarin Red) (2 Pan)</b><br><b>Floor Base Ass. (Mandarin Red) (3 Pan)</b><br><b>Floor Base Ass. (Mandarin Red) (4 Pan)</b><br><b>Floor Base Ass. (Mandarin Red) (5 Pan)</b>  | <b>HPS1370</b><br><b>HPS1373</b><br><b>HPS1376</b><br><b>HPS1793</b>                                     |

To order parts, contact your Winston representative or call the International office:

**Winston Products Co.**

**(800) 234-5286 USA & Canada/USA TEL: (502) 495-5400/USA FAX: (502) 495-5458**

# WINSTON HOT FOODS MERCHANDISER

## Parts Identification

| Photo Reference Number  | Part Description                                   | Order Number       |
|---|--|--------------------|
| 8   | Short Adapter                                      | HPS1513            |
| 9   | Long Adapter (2, 3, 4 Pan)<br>Long Adapter (5 Pan) | HPS1515<br>HPS1968 |
| 10  | Drain Cap  | HPS1654            |
| 11  | Drain Pipe   | HPS1833            |
| 12  | Water Heaters                                      | HPS1437            |
| 13  | Switch Guard                                       | HPS1086            |
| 14  | Evaporator Heat Lamp                               | HPS1103            |
| 15  | Dimmer Switch Dials                                | HPS1250            |
| 16  | Power Switch                                       | HPS1529            |
| 17  | Dimmer Switches                                    | HPS1528            |
| 18  | Heat Lamps (250 W, 120 Volt Infra-Red)             | <i>Ref. Only</i>   |
| 19  | Thermometer  | HPS1827            |
| <div style="border: 1px solid black; padding: 5px; width: fit-content; margin: 0 auto;"> <p><b>NOTE:</b> See pages 1 - 4<br/>for Photo Reference</p> </div> |  |                    |

To order parts, contact your Winston representative or call the International office:

**Winston Products Co.**

**(800) 234-5286 USA & Canada/USA TEL: (502) 495-5400/USA FAX: (502) 495-5458**



# WINSTON HOT FOODS MERCHANDISER

## Wiring Schematic

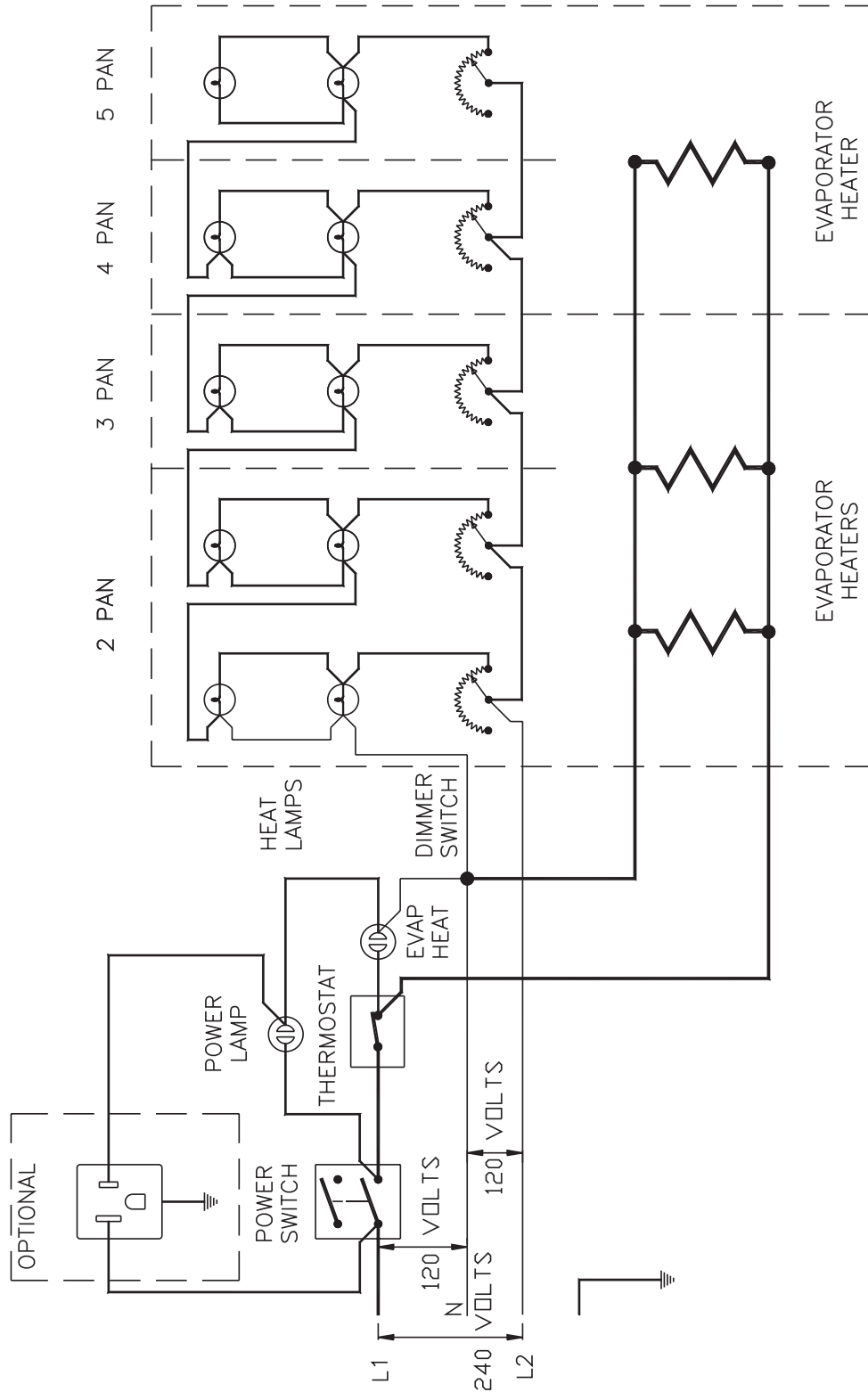

To order parts, contact your Winston representative or call the International office:

**Winston Products Co.**

**(800) 234-5286 USA & Canada/USA TEL: (502) 495-5400/USA FAX: (502) 495-5458**