



A WINSTON INDUSTRIES INNOVATION

# COOK & HOLD CABINET

*Owner's Manual*

**CA85 Series**

CA8509

CA8522



**WINSTON INDUSTRIES**  
THE TASTE OF INNOVATION

## WELCOME

Thank you for your purchase of a Winston CVap CA85 series Cook & Hold cabinet. The benefits you will enjoy from this cabinet include precise doneness temperatures, greater yields, safer foods, reduced labor, and superior food quality.

This cabinet utilizes Controlled Vapor Technology (CVap). Using a combination of dry and moist heat, CVap cabinets are capable of producing foods at the precise temperature and moist or crisp texture desired.

If you have any questions, or if anything cooked in your CVap Cook & Hold doesn't meet your satisfaction, please call our Customer Service Center at 1.800.234.5286, or email us at [customerservice@winstonind.com](mailto:customerservice@winstonind.com).

## TABLE OF CONTENTS

Welcome	2	Controls	9
Safety	3	Daily Operating Instructions	10-13
Receiving Your Equipment	4	Cooking Reference Chart	14-16
Ventilation Requirements	5	Roasting Guidelines	17
Water Supply	5	Daily Cleaning	18-19
Auto Water Fill	6	Troubleshooting	20-21
Electrical Information	7	Warranty and Terms & Conditions	22
Component Identification	8		

## NEED TO CONTACT US? CHOOSE THE MOST CONVENIENT METHOD.

Internet: [www.winstonfoodservice.com](http://www.winstonfoodservice.com)  
 Email: [customerservice@winstonind.com](mailto:customerservice@winstonind.com)  
 Phone: 1.800.234.5286 | 1.502.495.5400 | 1.502.495.5458  
 Mail: 2345 Carton Drive | Louisville, KY 40299 USA

### MISSION

Transforming the world's kitchens through innovation.

### VALUES

We operate with the highest integrity.  
 We are passionate, focused, and driven.  
 We celebrate one another's achievements.  
 We respect one another and work as a team.  
 We invest in the betterment of the global community.  
 We innovate through continuous improvement and discovery.

### FOUNDER'S PHILOSOPHY

"We are a family business. We believe in the entrepreneurial spirit, strong drive, and initiatives of individuals. The company was founded on the idea of an individual and flourished through the energy and sacrifice of family members and countless other individuals. Our commitment to those individuals is indistinguishable from that of our own family members. Together, we shall share the work, sacrifices, challenges, and triumphs of the business."

– Winston Shelton

Please read this entire owner's manual before operating your CVap Cook & Hold cabinet. The manual contains important safety information and operating instructions.

As is the case with all cooking appliances, your CVap Cook and Hold should be used with caution. Please read the following warnings to avoid potential injuries.

---

 **DANGER: Electrical Hazard** – Can cause serious injury or death. Do not attempt to install or service this equipment unless you are a licensed electrician or trained servicer.

---

1. Because this equipment utilizes high voltage, it should only be installed and serviced by a licensed electrician or trained servicer. Attempting to install or service the equipment yourself could result in serious, potentially fatal injuries.
2. If an electrical shock is felt when touching equipment, shut off power immediately (pull cord or turn off circuit breaker) and call a trained servicer for repair. Failure to do so could result in serious, potentially fatal injuries.
3. Always turn power switch off any time equipment is not in use.

---

 **CAUTION: Burn Hazard** – Can cause injury. Avoid heated vapor when opening or closing unit door.

---

4. This equipment utilizes heated water vapor, which transfers heat much more quickly and efficiently than dry air of the same temperature. Use caution when opening doors or reaching into the equipment, as heated vapor can quickly cause burns.

---

 **DANGER: Contamination Hazard** – Can cause serious illness or damage to equipment. Clean unit daily to avoid potential contamination hazard.

---

5. Clean equipment daily to prevent buildup of food residue or chlorides, which can damage stainless steel and contaminate food. Failure to follow proper cleaning procedures can void your warranty.

6. Prior to using equipment for the first time, perform the daily cleaning procedure found on pages 18 and 19.

---

 **CAUTION: Burn Hazard** – Can cause injury. Allow 30 minutes for equipment to cool before attempting to clean.

---

7. Always allow equipment to cool before cleaning.

---

 **CAUTION: High Temperature and Grease Hazard** – Can cause damage to equipment. Avoid placing equipment near high heat or grease-laden atmosphere.

---

Do not place equipment in an area where air temperatures exceed 100°F (38°C). A heat shield may be required to prevent heat exposure and grease-laden vapors from affecting the unit if adjacent to heat, vapor, or grease-generating devices (such as grills, steamers, ovens, etc.). Excess heat and grease inside the equipment cavities may cause electrical components to fail.

 **WARNING: Safety Hazard, Intended Use**

**Can cause serious injury or damage to equipment >> Supervise untrained, young, or handicapped persons.**

1. This equipment is not intended for use by persons (including children) with reduced physical, sensory, or mental capabilities, or lack of experience and knowledge, unless they have been given supervision or instruction concerning use of the equipment by a person responsible for their safety.
2. Children should be supervised to ensure that they do not play with the equipment.
3. This equipment is intended to be used for commercial applications, for example in kitchens of restaurants, canteens, hospitals and in commercial enterprises such as bakeries, butcheries, etc., but not for continuous mass production of food.

## **CUSTOMER FREIGHT RESPONSIBILITIES**

Thank you for your recent order. For your convenience, we have summarized your responsibilities for receiving a shipment and suggest procedures to follow if there is freight damage. Once an order has left the factory, all inspection responsibilities for the shipment passes on to you.

### **If Merchandise Is Delivered in Damaged Condition, You Must:**

1. Have the driver note the damage and sign all copies of the freight bill.
2. Examine for concealed damaged as soon as possible.
3. Notify carrier of the freight claim immediately (You have a 24-hour window).
4. Retain damaged merchandise and all original packaging until inspected by carrier.

### **Steps to Take at Time of Delivery to Protect Against Loss or Damage**

1. Verify Count - Make sure you receive as many cartons as are listed on the delivery receipt. Note any shortage on carrier's delivery receipt and have the driver note the shortage on your copy.
2. Carefully Examine Each Carton for Damage - If damage is visible, note this fact on the delivery receipt and have the driver clearly note the same on your copy. If the carton appears to have internal damage, insist that the package be opened. You and the driver should make joint inspection of the contents. Any concealed damage discovered should be noted on the receipt and on your copy.
3. Immediately After Delivery, Open All Cartons and Inspect for Concealed Damage.

### **Steps to Take When Visible or Concealed Damage Is Discovered**

1. Retain Damaged Items - The damaged items, shipping cartons, and all inner packing materials must be held in the receiving area until a carrier representative inspects them or waives the opportunity to inspect.

2. Call Carrier to Report Damage and Request Inspection - The call should be placed immediately upon discovery of the damage. Claims will be denied if not reported within 24/48 hours.
3. Confirm Call in Writing - For your own protection, confirm your telephone claim in writing using certified, return receipt requested mail.

### **Steps to Take When Carrier Makes Inspection of Damaged Items**

1. Have Damaged Items in Receiving Area - The damaged items should have not been moved from the receiving area. Allow the carrier inspector to inspect cartons, inner packing materials, and freight bill. Show your copy of the delivery receipt.
2. Carefully Read the Inspection Report Before Signing - If you do not agree with the report, do not sign it.

## VENTILATION REQUIREMENTS

---

 **CAUTION: High Temperature and Grease Hazard** – Can cause damage to equipment. Avoid placing equipment near high heat or grease-laden atmosphere.

---

Do not place equipment in an area where air temperatures around the equipment exceed 100°F (38°C). A heat shield may be required to prevent excessive heat exposure and grease-laden vapors from affecting the equipment if adjacent to heat, vapor, or grease-generating devices (such as grills, steamers, cabinets, etc.). Excess heat and grease inside the equipment cavities may cause electrical components to fail.

Ventilation clearances - To operate properly, the Cook & Hold will need sufficient space for air circulation. Allow at least 2" (51mm) clearance on all sides of the cabinet, particularly around ventilation holes. Care should be taken to prevent placing the cabinet close to anything combustible. It must be installed with its supplied legs, feet, or casters. Half-size units may be stacked upon each other using only a Winston supplied stacking kit and following the instructions enclosed with the kit. Your warranty may be void if you do not adhere to these ventilation requirements.

Vent hood - Generally this equipment does not need to be installed under a mechanical ventilation system (vent hood). Check local health and fire codes for specific requirements.

## WATER SUPPLY

In order to operate properly, the evaporator in this cabinet must be filled with clean, potable water. Hardware is included to connect the cabinet to a copper line in your facility's water system. If your facility has plastic or galvanized pipes, contact a licensed plumber to connect the water supply. Equipment should be installed to comply with applicable federal, state, or local plumbing codes.

Units with automatic water fill systems are to be installed with adequate backflow protection to comply with federal, state, and local codes.

As water evaporates, minerals in the water will deposit on the surface of the evaporator. These mineral deposits will inhibit the transfer of heat. Deposits can also degrade and damage stainless steel. To avoid mineral deposits, clean the equipment daily. It is advisable to contact your water utility for advice on minimizing deposit buildup.

Experience has shown that leaks occur by failing to clean and rinse evaporator daily. Leaking evaporators are not covered under warranty.

---

 **CAUTION: High Temperature Hazard** – Can cause damage to unit. Fill evaporator with water prior to turning power on, and do not allow evaporator to run dry.

---

---

 **CAUTION: Corrosion Hazard** – Can cause damage to equipment. Clean equipment daily to avoid corrosion damage.

---

**INSTALLING AUTO WATER FILL**

Insert tubing and push fully into the connector. (Reference drawing on this page.) Once seated, try to pull the tubing out of the connector so that the capture ring comes out (about 1/16" (1.6mm)) and the tubing cannot be removed.

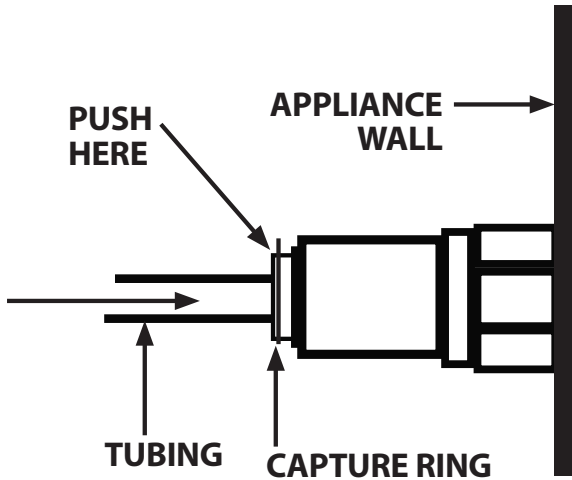

**The maximum incoming water temperature may not exceed 140°F (60°C) and the incoming water pressure must be between 20 and 150 psi (1.4 Kgf/cm2 to 10.5 Kgf/cm2 (kilogram-force per sq. centimeter)).**

---

**⚠ CAUTION: High Temperature Hazard** – Can cause damage to unit. Fill evaporator with water prior to turning power on, and do not allow evaporator to run dry.

---

**⚠ CAUTION: Corrosion Hazard** – Can cause damage to equipment. Clean equipment daily to avoid corrosion damage.

---

Regardless of whether the evaporator is filled with water manually or automatically, as water evaporates from the dual heat surface of the evaporator, any minerals in the water will deposit on those surfaces. The mineral deposits on the surfaces inhibit the ability to transfer heat through the deposits, and the stainless steel on which they are deposited can be degraded and destroyed. The first protection against this is the daily cleaning procedure. It is also recommended that your supplier of potable water be contacted for advice to minimize mineral deposit build-up. Experience has shown that leaks will occur only through failure to clean and rinse the evaporator daily. **LEAKING EVAPORATORS ARE NOT COVERED UNDER WARRANTY. This unit is to be installed to comply with the applicable federal, state, or local plumbing codes.**

## ELECTRICAL

The equipment is shipped from the factory with an 84" (2134mm) (minimum) power cord and plug. Refer to the table below to determine the correct electrical outlet. It may be necessary to hire a licensed electrician to install the correct outlet or wiring. Winston does not recommend hard wiring the equipment direct.

Model	Volts	Hertz	PH	Amps	Watts	Circuit Amps	Plug Type
CA8509	208	60	1	27.9	5805	30	US/CAN 6-30P
	240	60	1	24.2	5805	20	US/CAN 6-20P
	<b>International</b>						
	230	50	1	25.3	5805	N/A	N/A
CA8522	208	60	1	37.1	7716	50	US/CAN 6-50P
	208	60	3	23.7	7716	30	US/CAN 15-30P
	240	60	1	32.2	7716	50	US/CAN 6-50P
Not available for the international market at this time.							



## COMPONENT IDENTIFICATION

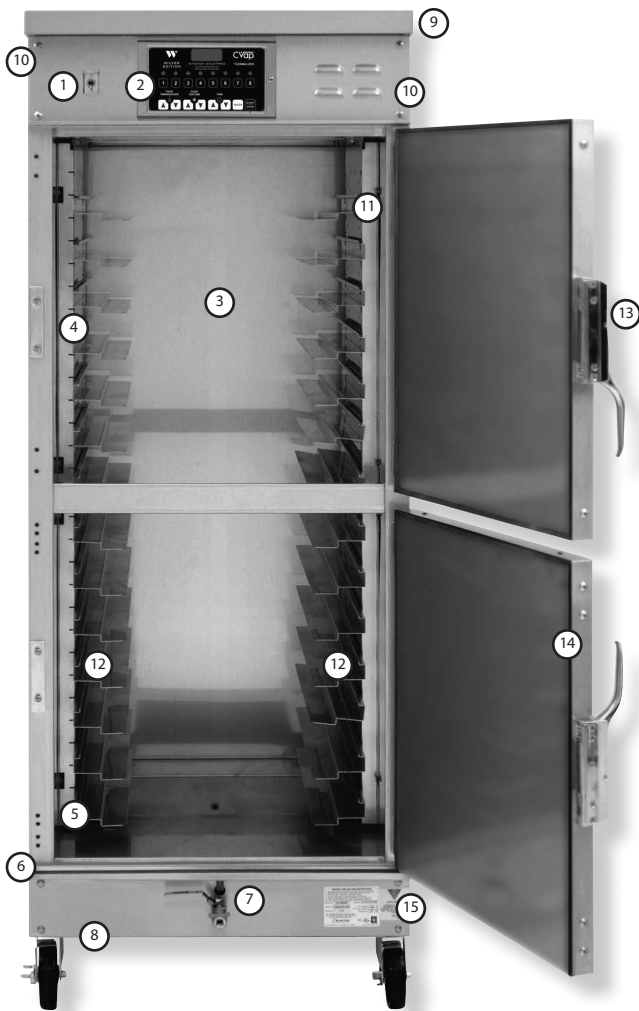

1. **Power Switch** allows operator to turn electrical power on and off.
2. **Microprocessor Controller** allows operator to select one of eight multi-interval programmable cycles and is removable for servicing or replacement.
3. **Food Chamber** cooking cavity where the dual heat system combines to create the perfect cooking environment.
4. **Adjustable Rack Support** supports racks onto which food is placed.
5. **Evaporator and Heater** (not visible) supply vapor atmosphere to the food chamber by heating water within the evaporator.
6. **Drain Trough** carries water that has condensed onto door back to evaporator.
7. **Drain Valve** enables operator to drain evaporator, to perform daily cleaning.
8. **Bottom Cover** (not visible) provides service access.
9. **Top Cover** provides service access.
10. **Side Panels** support insulation and form outside of cabinet.
11. **Rack Support Bracket** receives rack support.
12. **Air Heaters** (not visible) supply air heat for food texture control.
13. **Door & Latch** can be reversed on site.
14. **Door Gasket** seals food chamber against heat or vapor loss.
15. **Name Plate** identifies model and serial number — important for servicing and parts orders. Plate also displays electrical data.

Note: Equipment shown with optional rail supports. Standard unit comes with wire rack supports.

Model shown is CA8522. Highlighted features are common to all models.



## CONTROLS



1. **Mode Buttons** (cook / retherm / hold channels) provide operators with the ability to select desired mode of operation. Long press of these buttons allows operator to cancel out of a cook, retherm, or hold cycle. Buttons are numbered 1 through 8.
2. **Digital LED Readout** displays chosen setpoints for food temperature, food texture, and cook time as the cabinet is programmed. After pressing Start/ Stop button, the display indicates the remaining time in each portion of the cooking process.
3. **LED Program Lamps** indicate which mode is selected when illuminated above that button.
4. **Start/Stop Button** is used to start or stop the selected mode of operation. A long press from IDLE allows the operator to enter programming mode.
5. **Food Temperature Up (s) and Down (t) Buttons.** Short press either button to adjust temperature.
6. **Food Texture Up (s) and Down (t) Buttons.** Short press either button to adjust the level of moistness or crispness in food.
7. **Time Up (s) and Down (t) Buttons.** Short press either button to adjust cook time.
8. **HACCP Button** enables user to check current HACCP-relevant conditions inside the cabinet. It provides operator the ability to check current food temperature (E=evaporator), food texture (A=air), or dry air (D=differential) at any time during the cycle (see page 13). This button provides HACCP data recall for Gold and Platinum edition controls.



**What's the difference between a long press and a short press?**

**Short Press** - Press button, hold for less than 1 second.

**Long Press** - Press button, hold for more than 1.5 seconds.

## DAILY OPERATING PROCEDURE



 **DANGER: Contamination Hazard** – Can cause serious illness. Clean appliance prior to first use to remove traces of industrial chemicals and oils.

Prior to using equipment for the first time, perform the daily cleaning procedure listed on pages 18 and 19.

1. **Prepare unit for cooking/retherming/holding. Adjust rack supports in cabinet if required.**
2. **Fill evaporator with 3.5 gallons (13.3 liters) of water prior to operation.** We recommend filling manually at first, rather than waiting for the auto fill to fill it. Tip: Speed up initial cabinet preheat by using hot water (do not use water that's hotter than the desired food temperature. Locations with hard water should add one tablespoon white vinegar or lemon juice to water in evaporator to help prevent scale buildup. You may want to seek advice from your local water authority concerning possible water treatment necessary for the protection of the unit. Some water supplies are high enough in chemical content to be capable of destroying stainless steel if used untreated. The evaporation process can concentrate the chemicals to a level which causes a high interaction with stainless steel. When water is of unknown quality, automatic fill units should be connected to the water source through a deionizer/demineralizer. Experience has shown that leaks will occur by failing to clean and rinse the evaporator daily. **Leaking evaporators are not covered under warranty.**
3. **Operating and Programming Functions Using Preprogrammed Settings**  
**PREHEAT**
  - A. **Turn Power Switch on.** IDLE will display on the LED readout until operator selects mode. **Note: Unit will not preheat until program button is selected.**



- B.
  - **Select the desired preprogrammed mode** (short press); Buttons 1-8 (refer to guidelines on pages 14 through 16 for suggested cook/retherm cycles). A red light will appear above the selected button. Food temperature and food texture settings have been preprogrammed for each button 1-8 in the default mode. The operator must program a time value to initiate the timer function.
- C. Once a button is selected, the cabinet will enter a preheat mode and display **PRHT** on the LED display.
- D. When the cabinet reaches the selected channel's food temperature and food texture levels, the word **LOAD** will display on the LED, and a five-second alarm will sound.

### LOAD CABINET / COOK / RETHERM CYCLE

- A. Load cabinet with desired product.
- B.  Check time value to ensure it is correct (see check values description). Press the time s and t buttons to program a cook / retherm time (refer to suggested guidelines on pages 14 - 16).
- C.  Long press Start/Stop button to start the timer. The programmed cook/retherm time will display with a flashing colon. Cook/retherm time cycle will then count down.
- D. When timer reads 00:00, a five-second alarm will sound, and cabinet will automatically enter hold mode (hold food temperature and food texture settings are preprogrammed at the factory for buttons 1-8 in the default mode; time is indefinite). Hold will display until operator cancels program. Refer to guidelines on pages 14 through 16.

## DAILY OPERATING PROCEDURE

### HOLD CYCLE/UNLOAD CABINET

- A.  When the cook/retherm mode is complete, an alarm will sound, and the LED will display **HOLD** and **time value counting up**. Food will continue to hold at preprogrammed settings until Start/Stop button is pressed. Hold is an infinite time value.
- B. Either remove food product after cook/retherm cycle is complete and alarm sounds, or allow food to hold for food production flow and flexibility. We recommend that you open the door for one to five minutes after cook/retherm cycle when selecting buttons 1 through 7. This will help prevent overcooking.
- C.  Button 8 in the default mode is pre-programmed as a dedicated Hold Mode. Use this button to operate the unit as a holding cabinet. Program time value for total time needed. Note: Default setting is ten hours. You can use the Time up or down buttons to initiate a timed cycle, or as an egg timer. Time will count down to zero, then an alarm will sound until you add time or reset cycle. To reset, depress Button 8, or other channel button. To cancel cycle, depress channel button. The Start/Stop button is non-active in this setting.

#### Canceling a Cycle

To cancel a cook/retherm cycle at any point in the cycle:

- A. Long press the selected button. The red light will go off and unit will revert to **IDLE** on the LED display.  
or
- B.  Long press the Start/Stop button. Unit will revert to **IDLE** on the LED display.

### ELEC MESSAGE ON LED

 If the LED is displaying **ELEC** it indicates there has been a power interruption. This can occur if there is an interruption to the electrical power being supplied to the equipment (a blackout), or if the equipment's power switch is turned off during a cycle. To remove **ELEC** message, **long press** the Start/Stop button until the LED display reads **IDLE**. Proceed with normal application.

 **DANGER: Temperature Hazard** – Can cause serious illness. Verify that food temperature has not fallen into the danger zone.

If power is interrupted for an extended period, food temperature can drop out of the safe zone. Ensure that appropriate HACCP standards have been maintained prior to serving.













### 4. Programming Instructions

Winston's control enables the operator to manually program a cook or retherm cycle and hold cycle for each of the channel buttons (1–8). See below for description of programming modes.

- E1 = Food Temperature button/Temperature of moist heat cook/retherm cycle.
- Ehold = Food Temperature button/Temperature of moist heat hold cycle.
- A1 = Food Texture button/Total oven temperature of cook retherm cycle.
- Ahold = Food texture button/Total oven temperature of hold cycle.
- T1 = Cook/retherm time
- Cnst = Infinite hold time

Channel	Channel	Channel	Channel	Channel	Channel	Channel	Channel
Button 1	Button 2	Button 3	Button 4	Button 5	Button 6	Button 7	Button 8
E1	E1	E1	E1	E1	E1	E1	E1
E Hold	E Hold	E Hold	E Hold	E Hold	E Hold	E Hold	E Hold
A1	A1	A1	A1	A1	A1	A1	A1
A Hold	A Hold	A Hold	A Hold	A Hold	A Hold	A Hold	A Hold
T1	T1	T1	T1	T1	T1	T1	T1
CnST	CnST	CnST	CnST	CnST	CnST	CnST	CnST

## DAILY OPERATING PROCEDURE

- A.  Long Press the Start/Stop button. LED will display **PROG** (Program).
- B.  Short press desired channel button (1-8) to program. LED will light above chosen channel button.
- C.  To program intervals **E1, E Hold**: Depress the Food Temperature s and t buttons. **E1** will display, followed by the temperature values. Using the arrows, select desired temperature. Depress the channel button to move to **E Hold** interval. Depress the s and t buttons. **E Hold** will display, followed by the temperature values. Using the s and t buttons, select desired temperature.
- D.  To program intervals **A1, A Hold**: Depress the Food Texture s and t buttons. **A1** will display, followed by the temperature values. Using the s and t buttons, select desired temperature. Depress the channel button to move to **A Hold** interval. Depress the Food Temperature s and t buttons. **A Hold** will display, followed by the temperature values. Using the s and t buttons select desired temperature.
- E.  To program interval **T1**, depress the Time s and t buttons. **T1** will display, followed by the time values. Using the s and t buttons, select desired times. **T1** is only programmed using E1 and A1.
5. **Constant Cook Programming Instructions**
-  To program the oven to continuously cook (CnST), depress the Time s or t buttons until display reads **CnST**. NOTE: When programmed, **CnST** will allow constant cooking or retherming and **NO HOLD** cycle. NOTE: This also activates the egg timer. To cancel cycle, depress channel button. Start/Stop button is non-functional in this mode.
6. **Egg Timer Operation (only available when no hold values are selected, E Hold, A Hold)**
- A. Count-down timer is independent of heat control.  To set egg timer, press the Time s and t buttons. Set desired time.
- B. When timer reaches 00:00 value, alarm will sound.  The alarm may be disarmed by a short press of the Time t button. The equipment will not enter an automatic hold.
- C. Egg timer will read **CnST +** value.
- To cancel cycle, depress any channel button. Start/Stop button is non-functional in this mode.
7. **Set Delay Timer**
- The delay timer enables the operator to specify an amount of time before the oven will enter preheat mode.
- A. To enter delay programming, while in **IDLE**, long  press the Time s button.
- B.  The LED display will read **dLay**.
- C. Select the channel button to cook, retherm, or hold. LED light will illuminate over the button number.
- D. Using the Time s and t buttons, program the  number of hours until the desired preheat start.
- E.  Short press Start/Stop button.
- F.  Display will alternate between **dLay** and the amount of time remaining until preheat.
- G. At the specified time, delay mode will automatically engage heaters and enter a preheat mode for selected channel.
- H. Make sure evaporator has full load of water.

## DAILY OPERATING PROCEDURE



- I. Delay timer may be canceled with a long press of  Start/Stop button, returning the cabinet to IDLE mode.

### 8. To Check Cycle Settings

- A. The Water (evaporator) temperature may be checked at any time during a cycle by  pressing the HACCP button. Current water temperature will be displayed. Press the HACCP button again to display differential temperature between water and air. Press the HACCP button a third time for total water and air temperature.

- B.  To view programming settings, depress channel button (1–8) and long press Food Temperature t button. The LED display will read the following values: **E1, E Hold, A1, A Hold** consecutively.

 **To cancel cycle** – Any cycle may be cancelled by long pressing the Start/Stop button of selected mode after cycle has been started. IdLE will be displayed and cabinet will not heat until a mode has been selected.

  **To change from Fahrenheit to Centigrade** - Press and hold the Food Temperature t button and Food Texture s button at the same time, and then toggle the Food Texture s button to **CENT** or **FAHR**.

 **To disarm low water alarm** – hold down both Food Temperature s and t buttons and toggle.

## QUICK OPERATING PROCEDURES USING FACTORY PREPROGRAMMED SETTINGS

Here are some tips for operating your CVap Cook & Hold cabinet.

**To select mode** – Press desired channel button (1–8). Red LED lamp will light above selected channel.

**To start retherm mode** – When display shows **LoAd**, add food, program time (using Time s and t buttons), and then long press Start/Stop button.



**To check temperature** – Water (evaporator) temperature may be checked at any time during a cycle by  pressing the HACCP button. Current water temperature will be displayed. Press the HACCP button again to display differential temperature between water and air. Press the HACCP button a third time for total water and air temperature.

## COOK & HOLD GUIDELINES

- E** MOIST HEAT/FOOD TEMPERATURE
- D** DRY HEAT
- A** TOTAL OVEN TEMPERATURE/FOOD TEXTURE

### Channel 1

#### Slow Moist Cook/Retherm

190 40 230

#### Menu

Wrapped sandwiches (e.g., frozen/thawed hot dogs, hamburgers, chicken), BBQ items (e.g., pulled beef pork riblets, ground meat), vegetables (e.g., frozen, canned, fresh vacuum-packed bags/chubs), pizza (moist, soft crust no color), combination dishes (e.g., lasagna/casseroles/eggs).

#### Retherm (minutes)

Thawed 25-35 Frozen 30-70

#### Hold

Auto Soft Moist Hold  
 Food Temp 150°F (66°C)  
 Food Texture 160°F (71°C)

### Channel 2

#### Moist Bake

170 120 290

#### Menu

Pizza (moist with some browning), breakfast items (e.g., pancake on stick, french toast, waffles, smiles), grilled cheese, hot pockets, pizza sticks, burritos, egg rolls, hashbrowns, fish patty, chicken patty, grilled proteins, biscuits, and desserts (e.g., pies/rolls/bar cookies).

#### Retherm (minutes)

Thawed 14-25 Frozen 18-30

#### Hold

Auto Moist  
 Bake Hold  
 Food Temp 150°F (66°C)  
 Food Texture 175°F (79°C)

### Channel 3

#### Moist Cook/Retherm

190110 300

#### Menu

Fast bake pizza (moist with some browning), chicken patty, fish patty (whole meat product), wrapped sandwiches (e.g., frozen/thawed hot dogs, burgers, chicken), BBQ items (e.g., pulled pork ribs), large proteins and combination foods (e.g., casseroles), vegetables (fresh, frozen, canned), and desserts (e.g., individual cookies, rolls, pies, cakes).

#### Retherm (minutes)

Thawed 12-30 Frozen 30-70

#### Hold

Auto Moist Hold  
 Food Temp 150°F (66°C)  
 Food Texture 160°F (71°C)



## COOK & HOLD GUIDELINES

**E** MOIST HEAT/FOOD TEMPERATURE

**D** DRY HEAT

**A** TOTAL OVEN TEMPERATURE/FOOD TEXTURE

### Channel 4

#### Crisp Bake

150 200 350

#### Menu

Crisp chicken patty, fish patty, steak, popcorn/breaded foods, french fries, potato products, or items typically cooked in fryer (note: items must be bakable).

#### Retherm (minutes)

Thawed 12-30 Frozen 12-60

#### Hold

Auto Crisp Hold

Food Temp 140°F (60°C)

Food Texture 190°F (88°C)

### Channel 5

#### Extra Crisp Bake

130 220 350

#### Menu

Bake-only fries, tater tots, or extra crispy items.

#### Retherm (minutes)

Thawed 12-30 Frozen 12-60

#### Hold

Auto Crisp Hold

Food Temp 130°F (54°C)

Food Texture 190°F (88°C)

### Channel 6

#### Rapid Retherm

190 110 350

#### Menu

Baked potatoes or casseroles.

#### Retherm (minutes)

Thawed 15-40 Frozen 30-90

#### No Hold.

Remove product when Retherm cycle is completed.

## COOK AND HOLD GUIDELINES

- E** MOIST HEAT/FOOD TEMPERATURE
- D** DRY HEAT
- A** TOTAL OVEN TEMPERATURE/FOOD TEXTURE

### Channel 7

#### Menu

Sheet cakes/pastries or general bake cycle.

#### Bake

170 180 350

#### Retherm (minutes)

Thawed 20-60 Frozen 60-300

#### Auto Bake Hold

Food Temp 150°F (66°C)

Food Texture 180°F (82°C)

### Channel 8

#### Menu

Holding of foods with moist/firm texture.

#### General Holding

150 30 180

#### Retherm (minutes)

Thawed - Constant Frozen - Constant

#### General Hold

Food Temp 150°F (66°C)

Food Texture 180°F (82°C)

## ROASTING GUIDELINES COOK AND HOLD

MENU	REThERM		ROASTING TIME	HOLD	
	Food Temp	Food Texture		Food Temp	Food Texture
<b>Top &amp; Bottom Rounds</b>					
<b>Rare</b>	130-135°F 54-57°C	160-175°F 71-79°C	5-7 hrs. 30 minutes per lb. 66 minutes per kg.	130°F 54°C	135°F 57°C
<b>Medium</b>	140-145°F 60-63°C	170-175°F 77-79°C		140°F 60°C	145°F 63°C
<b>Well-done</b>	145-150°F 63-66°C (30° differential)	175-180°F 79-82°C		140°F 60°C	145°F 63°C
<b>Corned Beef</b> (requires minimum 2-hour hold)	190°F 93°C	250°F 121°C	20 minutes per lb. 44 minutes per kg.	165°F 74°C	180°F 82°C
<b>Beef Brisket</b> (requires minimum 2-hour hold)	190°F 88°C	220°F 104°C	20 minutes per lb. 44 minutes per kg.	165°F 74°C	180°F 82°C
<b>Chicken</b> Breast 4-6 oz. (113-170g)	140-165°F 60-74°C	185-200°F 85-93°C	30-60 minutes	140°F 60°C	165°F 74°C
Whole	140-165°F 60-74°C	300-350°F 149-177°C	45-60 minutes	140°F 60°C	165°F 74°C
<b>Turkey</b> (25-lb (11.3-kg)), whole or breast (recommend overnight for whole)	140-165°F 60-74°C	300-350°F 149-177°C	5 hours or 12 minutes per lb. 27 minutes per kg.	140°F 60°C	165°F 74°C
<b>Ham (football)</b>	190°F 88°C	230-300°F 110-149°C	15 minutes per lb. 33 minutes per kg.	150°F 66°C	160°F 71°C
<b>Pork Ribs</b> (requires minimum 1-hour hold)	190°F 93°C	230°F 110°C	2 - 2.5 hours	140°F 60°C	165°F 74°C
Hamburger Raw	140-165°F 60-74°C	225-350°F 107-177°C	20 - 60 minutes	140°F 60°C	165°F 74°C
<b>Fish/Seafood Filet</b>	140-160°F 60-71°C	200-300°F 93-149°C	30 - 60 minutes	140°F 60°C	165°F 74°C

- Time and temperature settings are recommended guidelines only. Due to variations in the products' quality, weight, and desired degree of doneness, the cooking times may need to be adjusted accordingly.

## DAILY CLEANING

### Required Cleaning Accessories & Supplies

- Pan for draining evaporator (unless utilizing floor drain).
- Food grade germicidal detergent.
- Descaling agent (Citranox™).

---

 **DANGER: Electrical Hazard** – Can cause serious injury or death. Do not attempt to install or service this equipment unless you are a licensed electrician or trained servicer.

---

---

 **DANGER: Contamination Hazard** - Can cause serious illness. Clean equipment daily and prior to first use, to remove traces of industrial chemicals and oils.

---

Ensure safe operation by **cleaning cabinet daily**. Failure to do so can allow harmful deposits to develop, increasing the potential for food contamination and endangering your customers.

---

 **CAUTION: Corrosion Hazard** - Can cause damage to equipment. Clean equipment daily to avoid potential corrosion damage.

---

Clean evaporator **daily** to prevent chlorides (salts) from accumulating. Chlorides can cause the evaporator tank to corrode, to the extent that leaks can occur. Leaks caused by corrosion, which is caused by a failure to clean daily, are not covered under the manufacturer's warranty.

---

 **DANGER: Contamination Hazard** - Can cause serious illness. Clean equipment prior to first use, to remove traces of industrial chemicals and oils.

---

Prior to using equipment for the first time, perform the daily cleaning procedure listed below.

---

 **CAUTION: Burn Hazard** – Can cause injury. Allow 30 minutes for equipment to cool before attempting to clean.

---

Before each cleaning procedure, disconnect equipment from its electrical power source and allow to cool for at least one half hour.

1. Place empty pan under drain valve, open valve, and allow evaporator to drain.
2. Remove and clean rack supports using a food grade germicidal agent. Clean probe (if included) with mild soap and water.
3. Spray food chamber and evaporator with a food grade germicidal detergent.
4. Wipe inside surfaces to remove all food deposits.
5. Inspect for scale build-up on tank surface, float, and probe. (see photo on page 19). If present, apply descaling agent. Read ALL warnings and follow directions listed on descaling agent package.

6. Inspect heating elements (if exposed). The heating elements are stainless steel. If cleaning is needed, scrub with a Teflon<sup>®</sup> or nylon bristle brush to remove heavy food particles. Further cleaning may be done with a plastic scouring pad and alkaline-based cleansers. **DO NOT** use wire brushes, scrapers, steel wool pads, or chloride-based cleansers. Follow cleanser manufacturer's instructions for use on stainless steel. Rinse well several times with clean water and wipe immediately.



**DANGER: Electrical Hazard** – Can cause serious injury or death. Avoid spraying equipment exterior or controls with water.

---

7. Rinse all inside surfaces, including evaporator, and dry with clean towel.  
Do not spray outside of equipment or controls with water.
8. Rinse, dry, and replace rack supports.
9. Verify that valve is closed.
10. Reconnect equipment to electrical power and make ready for use.

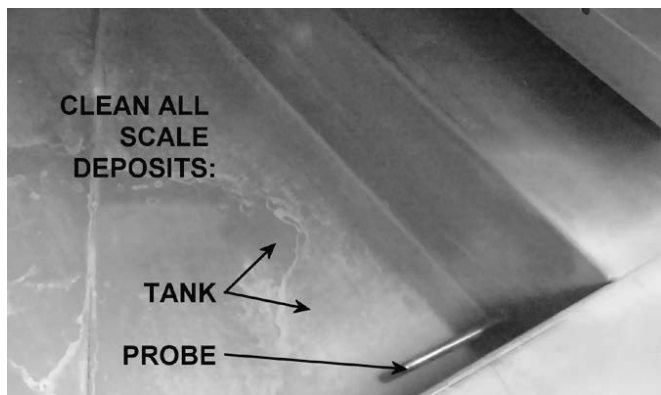

## TROUBLESHOOTING

We know how frustrating and costly it can be when a critical piece of equipment is down for repairs. It is our goal to minimize service disruptions, to get you back up and operating in the shortest time possible.

We carefully analyze all service calls. This analysis helps us to improve our manufacturing processes, and reduces product service issues. Generally speaking, most equipment failures can be attributed to the following three causes:

- Faulty use and care practices.
- Electrical supply problems.
- Equipment faults.

Please refer to the Troubleshooting Chart on the next page for common problems and solutions. If the problem you're experiencing isn't listed, or if the standard solution fails to resolve your problem, you will need a qualified servicer to diagnose and repair the problem.

If your equipment is still under warranty, or you are uncertain whether or not warranty is still in place, please call Winston Customer Service at 1.800.234.5286 (or 1.502.495.5400). Our friendly staff will help you verify coverage, and if under warranty, will arrange for a servicer to call on you.

If your equipment is no longer under warranty, please call Customer Service or visit our website at [www.winstonfoodservice.com](http://www.winstonfoodservice.com), and click the Service tab to locate an authorized servicer near you.

In order to expedite service, please have the complete model and serial number (found on the equipment's identification tag) on hand when you contact us.

Service parts may be purchased directly from the factory online. Visit [www.winstonfoodservice.com](http://www.winstonfoodservice.com)

Please have the following information on hand when contacting Winston Industries regarding product service.

Model Serial # (located on name plate)

---

Your name

---

Company name

---

Company address

---

Company phone

---

Type of problem

---

---

---

---

---

---



**troubleshooting**

TROUBLE	FAULT CODE
Digital display fails to light .....	A
Flooding/leaking water.....	G, H
Food drying out.....	B, D, E, G
Food excessively moist.....	C, F
Food not hot enough .....	B, D, F, G
Food too hot .....	C, E
Injury or accident .....	I

FAULT	CORRECTION
A. Circuit breaker tripped.....	Adjust
Fuse blown .....	Replace
Power cord not plugged in .....	Adjust
Faulty cordset.....	Call servicer
Faulty power switch.....	Call servicer
B. Evaporator (water) tank empty.....	Adjust, see pg. 10
C. Food Temperature setting too high.....	Adjust, see pg. 12
D. Food Temperature setting too low.....	Adjust, see pg. 12
E. Food Texture setting too high.....	Adjust, see pg. 12
F. Food Texture setting too low.....	Adjust, see pg. 12
G. Door gasket defective .....	Replace
H. Drain valve defective or missing .....	Replace
I. Injury or accident - call manufacturer.....	Administer first aid. If necessary, call 911 for emergency assistance. Then contact Winston at 1.800.234.5286

## WARRANTY AND TERMS AND CONDITIONS

Limited 1 year Warranty (excluding gaskets, lamps, hoses, power cords, glass panels, fryer baskets, batteries, and evaporators). Warranty disclaimer for failure to clean.

WINSTON EXPRESSLY DISCLAIMS ALL OTHER WARRANTIES, EITHER EXPRESS OR IMPLIED, INCLUDING ANY IMPLIED WARRANTY OF FITNESS FOR A PARTICULAR PURPOSE AND ANY IMPLIED WARRANTY OF MERCHANTABILITY.

Ask us for a complete warranty disclosure or go to:

[www.winstonind.com/Documents/4272V089\\_zap\\_warranty\\_agreement.pdf](http://www.winstonind.com/Documents/4272V089_zap_warranty_agreement.pdf).

Terms and Conditions of Sale for Winston Industries' products are available here:

[www.winstonind.com/Documents/4272X833\\_terms\\_and\\_conditions\\_of\\_sale.pdf](http://www.winstonind.com/Documents/4272X833_terms_and_conditions_of_sale.pdf).

Both the Warranty and Terms and Conditions of Sale are integral to this document.

### **Buy Winston Parts Online!**

**Parts and accessories for our products are available to purchase through our online, secure site – it's your one-stop shop for genuine Winston replacement parts. These parts are designed specifically for our products and can help you save on costly repairs while maintaining valuable warranty coverage.**

<http://www.winstonparts.com/>





**WINSTON INDUSTRIES**  
THE TASTE OF INNOVATION

Winston Industries LLC | 2345 Carton Drive | Louisville, KY 40299  
1.800.234.5286 | 1.502.495.5400 | Fax 1.502.495.5458 | [www.winstonfoodservice.com](http://www.winstonfoodservice.com)